

## DISTRIBUTORI MONOBLOCCO MONOBLOCK DIRECTIONAL CONTROL VALVES



<b>CARATTERISTICHE</b> <b>FEATURES</b>	F-2
<b>CARATTERISTICHE TECNICHE</b> <b>TECHNICAL CHARACTERISTICS</b>	F-3
<b>ESEMPIO DI ORDINAZIONE IN CODICE</b> <b>ORDERING CODE EXAMPLE</b>	F-5
<b>Q35</b>	F-6
<b>Q15</b>	F-8
<b>Q25</b>	F-10
<b>Q45</b>	F-12
<b>Q65</b>	F-14
<b>Q75</b>	F-16
<b>Q95</b>	F-18

## CARATTERISTICHE

- Elevate prestazioni tecniche che consentono una vasta applicazione.
- Corpo in ghisa speciale ad alta resistenza per essere adatto alle alte pressioni di lavoro.
- Cursori nichelati ad alto scorrimento che permettono di poter lavorare ad alte pressioni con lunga durata di vita.
- Il circuito standard in parallelo offre manovre simultanee e, grazie a ricoprimenti negativi e metering dedicati, si ottengono movimenti proporzionali agli utilizzi.
- Trafilamenti di valore ridottissimo.
- Intercambiabilità dei cursori, anche con quelli dei distributori componibili aventi schema "parallelo" o "singolo".
- Possibilità di inversione del lato di comando ruotando il cursore di 180°, consentendo così unificazione, versatilità, bassi valori di particolari a magazzino.
- Il tipo di libera circolazione a "Y" permette alte portate con basse perdite di carico, in rapporto alle ridotte dimensioni del distributore.
- Fa eccezione Q35 che ha ricoprimento positivo e una gamma di cursori apposita, sempre intercambiabili tra loro.

## CHARACTERISTICS

- *High technical performances granting larger application range.*
- *Special high resistance cast-iron body, suitable for high working pressures.*
- *Nickel-plated offering granting long working life under high pressure conditions (see attached scheme).*
- *Standard circuit in parallel grants simultaneous operations, and due to negative overlaps and dedicate metering, there is proportional movement at the working ports.*
- *Minimal internal leakages.*
- *Interchangeability of the spools also with the ones of the sectional valves with "parallel" or "single" scheme*
- *Possibility to reverse the control side, turning the spool of 180° permits unification, versatility and low value of some parts in stock.*
- *Free movement version "Y shape" allows high oil flow with low pressure drops, in relation with the small dimensions of the control valves.*
- *Above features not valid for Q35 having positive overlap. The Q35 spools are interchangeable.*



## AVVERTENZA PER L'INSTALLAZIONE DEI DISTRIBUTORI

- I tre piedini dei distributori devono sempre appoggiare su una superficie perfettamente piana
- Non utilizzare raccordi conici su filetti cilindrici.
- Per pulire il distributore, prima della verniciatura, non utilizzare diluenti/solventi o qualsiasi prodotto che possa intaccare le parti in gomma.

## NOTES FOR DIRECTIONAL CONTROL VALVES ASSEMBLY

- *The three feet of the valve must always and perfectly rest on a 180° degree flat surface.*
- *No conical nipples with JIC thread must be used.*
- *Before painting the control valve, do not use diluents or any products that could damage rubber parts.*

## CARATTERISTICHE TECNICHE

## TECHNICAL CHARACTERISTICS

	Q35	Q15	Q25	Q45	Q65	Q75	Q95
<b>Numero massimo di sezioni di lavoro</b> <i>Working sections maximum</i>	1	1	8		1	6	6
<b>Limiti temperatura olio</b> <i>Oil temperature range</i>	-30 ÷ 80 °C						
<b>Temperatura olio consigliata</b> <i>Recommended oil temperature</i>	30° ÷ 60 °C						
<b>Filtraggio consigliato</b> <i>Recommended filtration</i>	26/23µm ISO DIS 4406						
<b>Fluido</b> <i>Hdraulic fluid</i>	Olio minerale <i>Mineral oil</i>						
<b>Viscosità</b> <i>Viscosity</i>	10 ÷ 400 mm <sup>2</sup> /s						

<b>Massa [Kg]</b> <i>Weight (lbs)</i>	<b>1</b> Sezione di lavoro <i>Working section</i>	1.85 (4.1)	1.20 (2.6)	3.00 (6.6)	3.40 (7.5)	5.70 (12.6)	5.70 (12.6)
	<b>2</b> Sezioni di lavoro <i>Working sections</i>	—	—	4.50 (9.9)	—	7.60 (16.8)	7.60 (16.8)
	<b>3</b> Sezioni di lavoro <i>Working sections</i>	—	—	5.60 (12.3)	—	10.40 (22.9)	10.40 (22.9)
	<b>4</b> Sezioni di lavoro <i>Working sections</i>	—	—	7.30 (16.1)	—	12.40 (27.3)	—
	<b>5</b> Sezioni di lavoro <i>Working sections</i>	—	—	8.90 (19.6)	—	14.50 (32.0)	14.8 (32.6)
	<b>6</b> Sezioni di lavoro <i>Working sections</i>	—	—	10.1 (22.3)	—	16.60 (36.6)	18.3 (40.4)
	<b>7</b> Sezioni di lavoro <i>Working sections</i>	—	—	11.0 (24.3)	—	—	—
	<b>8</b> Sezioni di lavoro <i>Working sections</i>	—	—	13.6 (30.0)	—	—	—

<b>Pressioni massime di lavoro [bar]</b> <i>Max working pressure (PSI)</i>	<b>1 o 2 sezioni di lavoro</b> <i>from 1 up to 2 sections</i>	300 (4350)	250 (3625)	350 (5075)	350 (5075)	350 (5075)	350 (5075)
	<b>3 sezioni</b> <i>3 sections</i>	—	—	320 (4640)	—	300 (4350)	300 (4350)
	<b>da 4 a 8 sezioni</b> <i>from 4 up to 8 sections</i>	—	—	300 (4350)	—	270 (3915)	270 (3915)
<b>Pressione massima sullo scarico [bar]</b> <i>Max back pressure (PSI)</i>	25 (363)						
A richiesta, solo su monoblocco 1 o 2 sezioni, contropressione sullo scarico 180 bar (indicare la lettera "S" al termine del codice) On request, 1 or 2 section monoblock valve only, max back pressure allowable is 2610 PSI (indicate the letter "S" at the end of code)							
	•	—	•	•	—	—	—

## ESEMPIO DI ORDINAZIONE IN CODICE ORDERING CODE EXAMPLE

Tipo Type	Fiancata d'ingresso Inlet section		Sezione di lavoro Working section				Fiancata di scarico Outlet section	Note aggiuntive Additional notes	
Q25	F7S	R250	2x	103	A1	M1	F3D	12V	2E
1	2	3		4	5	6	7	8	9

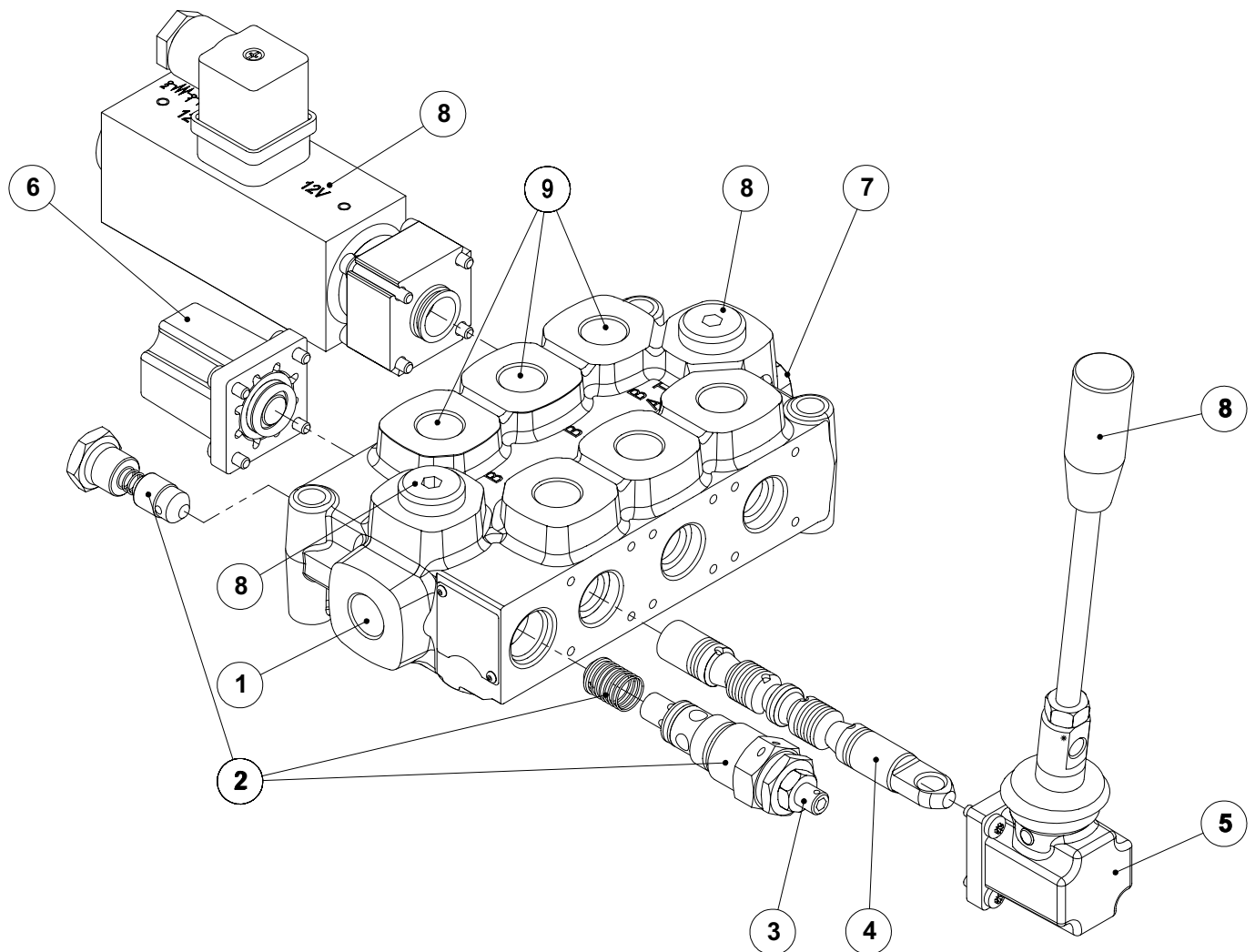



## ESEMPIO DI ORDINAZIONE IN CODICE ORDERING CODE EXAMPLE

### Tipo

**1 - Tipo**  
**Q15, Q35, Q25, Q45, Q65, Q75, Q95**

Indica il tipo di distributore; le caratteristiche dimensionali sono riportate da pag. F6 a pag. F19

### Type

**1 - Type**  
**Q15, Q35, Q25, Q45, Q65, Q75, Q95**

*Indicates model valve, characteristics and dimensions found on pages F6 to page F19.*

### Fiancata d'ingresso

**2 - Tipo fiancata d'ingresso** (pag. F-20)

**3 - Tipo molla e taratura valvola** (pag. F-20)

Dove è presente la valvola VLP (fiancate F1S e F7S), deve essere specificato il tipo di molla (**B, N o R**) e la sua pressione di taratura; se quest'ultima viene omessa verrà montata la molla N tarata a **150** bar.

### Inlet section

**2 - Inlet section type** (page F-20)

**3 - Type of spring and valve setting** (page F-20)

*If valve VLP is installed (inlet section F1S and F7S), specify the type of spring (**B, N or R**) and its pressure setting. If omitted, spring N with a **150** bar setting will be installed.*

### Sezione di lavoro

I campi da 4 a 6 sono da ripetere per ogni sezione. Nel caso in cui due sezioni contigue siano identiche, è sufficiente descriverne solo una antepoendo **2x** al campo 4.

N.B. Il numero massimo complessivo di sezioni di lavoro sono indicate a pag. F3.

**4 - Tipo cursore** (pag. F-21)

**5 - Tipo di comando** (pag. F-25)

**6 - Tipo posizionatore** (pag. F-31)

### Working section

*Fields 4 to 6 must be repeated for each section. If two adjacent sections are identical, just describe one and put **2x** before field 4.*

*NOTE. The maximum overall number of working sections is indicated on page F3.*

**4 - Spool type** (page F-21)

**5 - Control type** (page F-25)

**6 - Positioner type** (page F-31)

### Fiancata di scarico

**7 - Tipo fiancata di scarico** (pag. F-58)

### Outlet section

**7 - Outlet section type** (page F-58)

### Note aggiuntive

**8 - Note aggiuntive** (pag. F-59)

**9 - Numero elementi** (pag. F-59)

Specificare il numero delle sezioni di lavoro (es. 2E) previste.

### Additional notes

**8 - Additional notes** (page F-59)

**9 - Number of sections** (page F-59)

*Specify the number of working sections needed (e.g. 2E).*

**Q35**

**DISTRIBUTORI MONOBLOCCO  
MONOBLOCK DIRECTIONAL CONTROL VALVES**

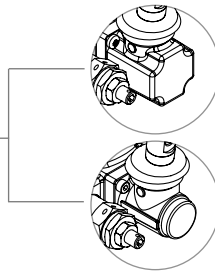
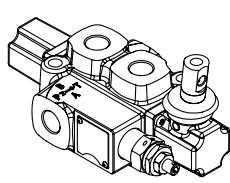

(Standard)  
Comando e posizionario in plastica  
*Control and positioner plastic*

**S**  
Comando e posizionario in Alluminio  
*Control and positioner Aluminium*

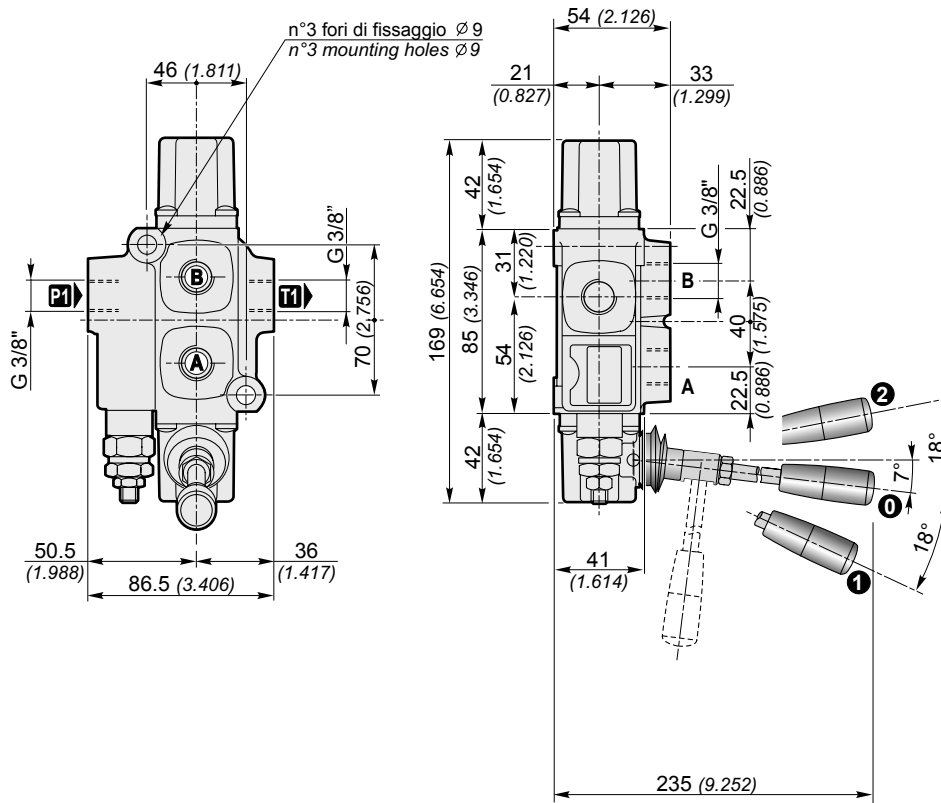

Filettature disponibili / Available ports

Bocche Ports	BSP (standard)	SAE	BSP G 1/2"
<b>P1</b>	G 3/8"	3/4" - 16 UNF (SAE8)	BSP G 1/2"
<b>A-B</b>	G 3/8"	3/4" - 16 UNF (SAE8)	BSP G 1/2"
<b>T1</b>	G 3/8"	3/4" - 16 UNF (SAE8)	BSP G 1/2"

Dimensioni in / Dimensions in: mm (inch)

**Q35**

**DISTRIBUTORI MONOBLOCCO  
MONOBLOCK DIRECTIONAL CONTROL VALVES**

**Perdite di carico con il cursore in posizione neutra**  
*Pressure drop with spool in neutral position*

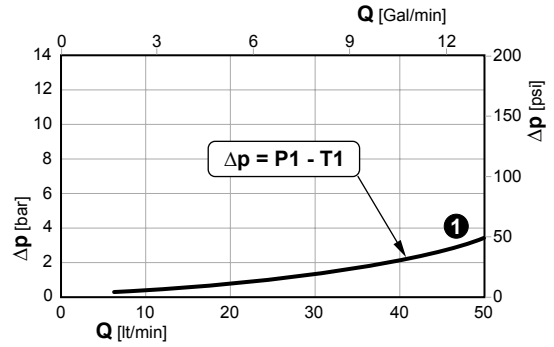
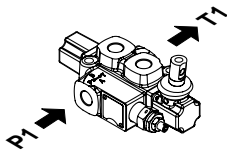

**Perdite di carico con il cursore in posizione di lavoro**  
*Pressure drop with spool in working position*

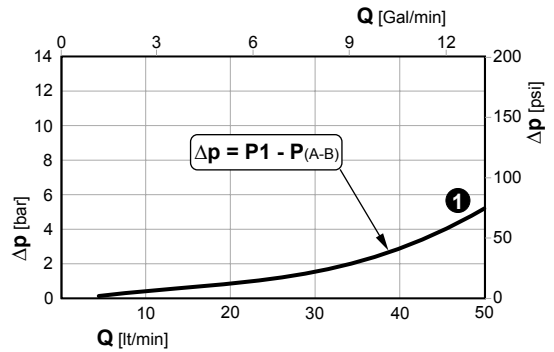
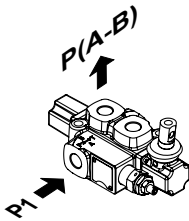

**Perdite di carico con il cursore in posizione di lavoro**  
*Pressure drop with spool in working position*

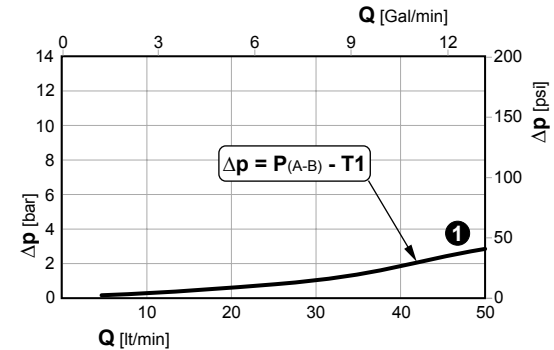
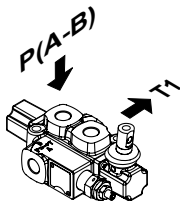

① Sezioni / Sections

**Curve di progressività**  
*Spool metering*

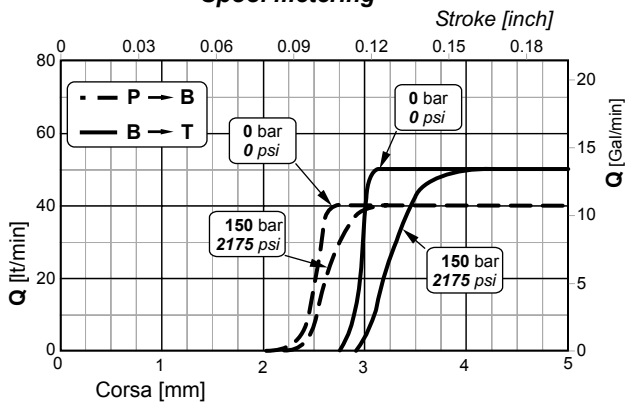

**Trafilamenti sul cursore**  
*Spool leakage*

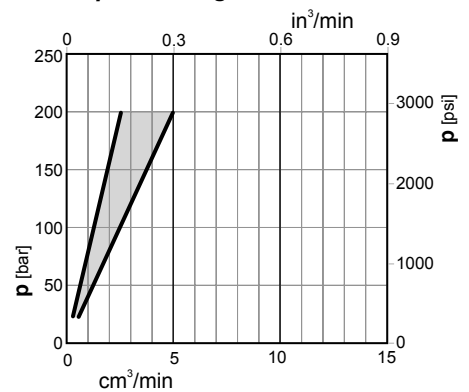

N.B. Le curve sono ricavate con cursore 103 / NOTE. Performance curves measured using spool 103 type.

**Q15**

**DISTRIBUTORI MONOBLOCCO  
MONOBLOCK DIRECTIONAL CONTROL VALVES**

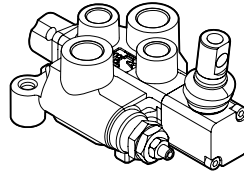

n°2 fori di fissaggio  $\varnothing 7$   
n°2 mounting holes  $\varnothing 7$

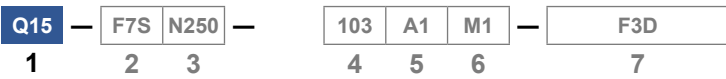
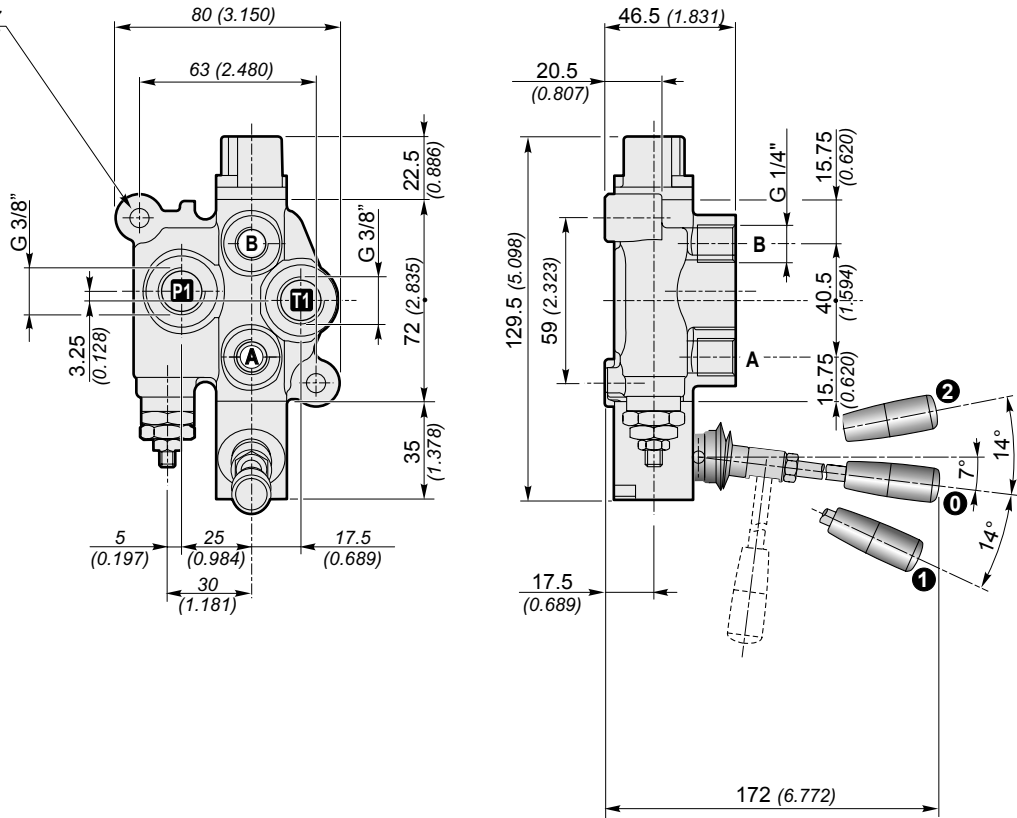

Filettature disponibili / Available ports

Bocche Ports	BSP (standard)	SAE
P - T	G 3/8"	9/16" - 18 UNF
A - B	G 1/4"	1/2" - 20 UNF

# Q15

## DISTRIBUTORI MONOBLOCCO MONOBLOCK DIRECTIONAL CONTROL VALVES

**Perdite di carico con il cursore in posizione neutra**  
*Pressure drop with spool in neutral position*

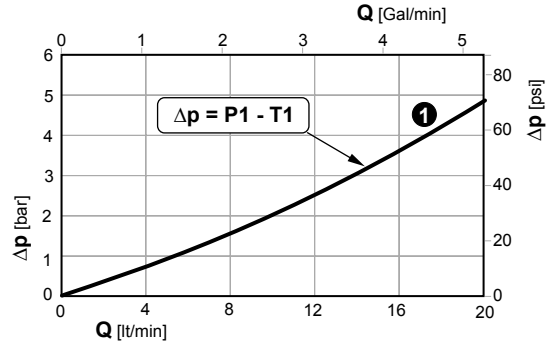
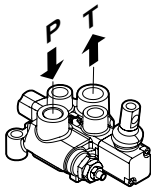

**Perdite di carico con il cursore in posizione di lavoro**  
*Pressure drop with spool in working position*

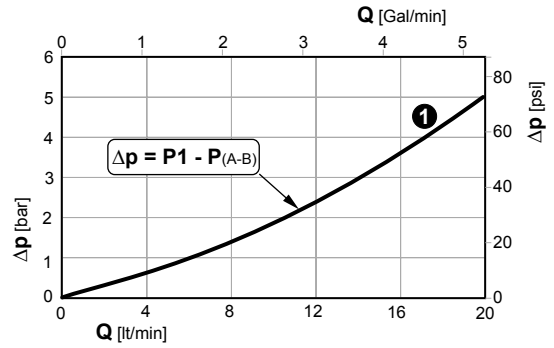
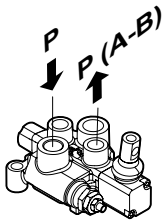

**Perdite di carico con il cursore in posizione di lavoro**  
*Pressure drop with spool in working position*

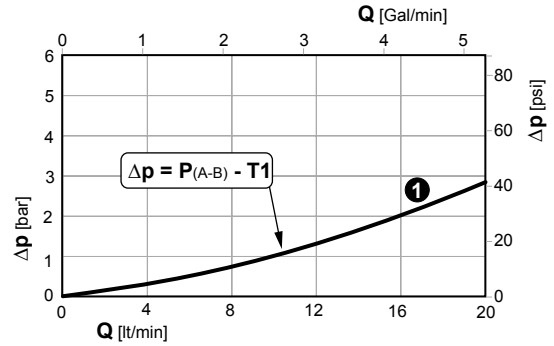
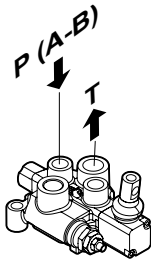

1 Sezioni / Sections

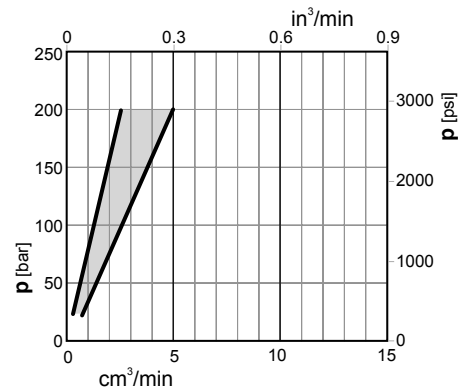
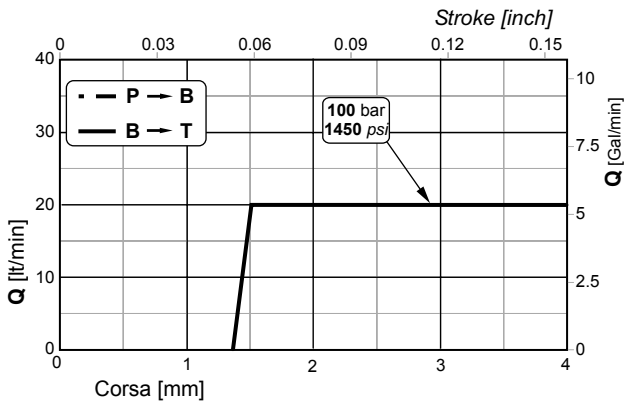

N.B. Le curve sono ricavate con cursore 103 / NOTE. Performance curves measured using spool 103 type.

# Q25

## DISTRIBUTORI MONOBLOCCO MONOBLOCK DIRECTIONAL CONTROL VALVES

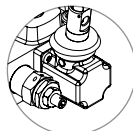
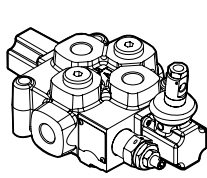

(Standard)  
Comando e posizionatore in plastica  
Control and positioner plastic

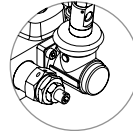

**S**  
Comando e posizionatore in Alluminio  
Control and positioner Aluminium

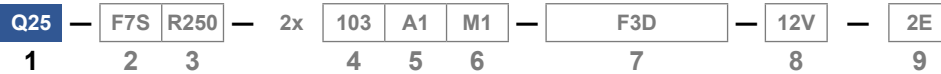
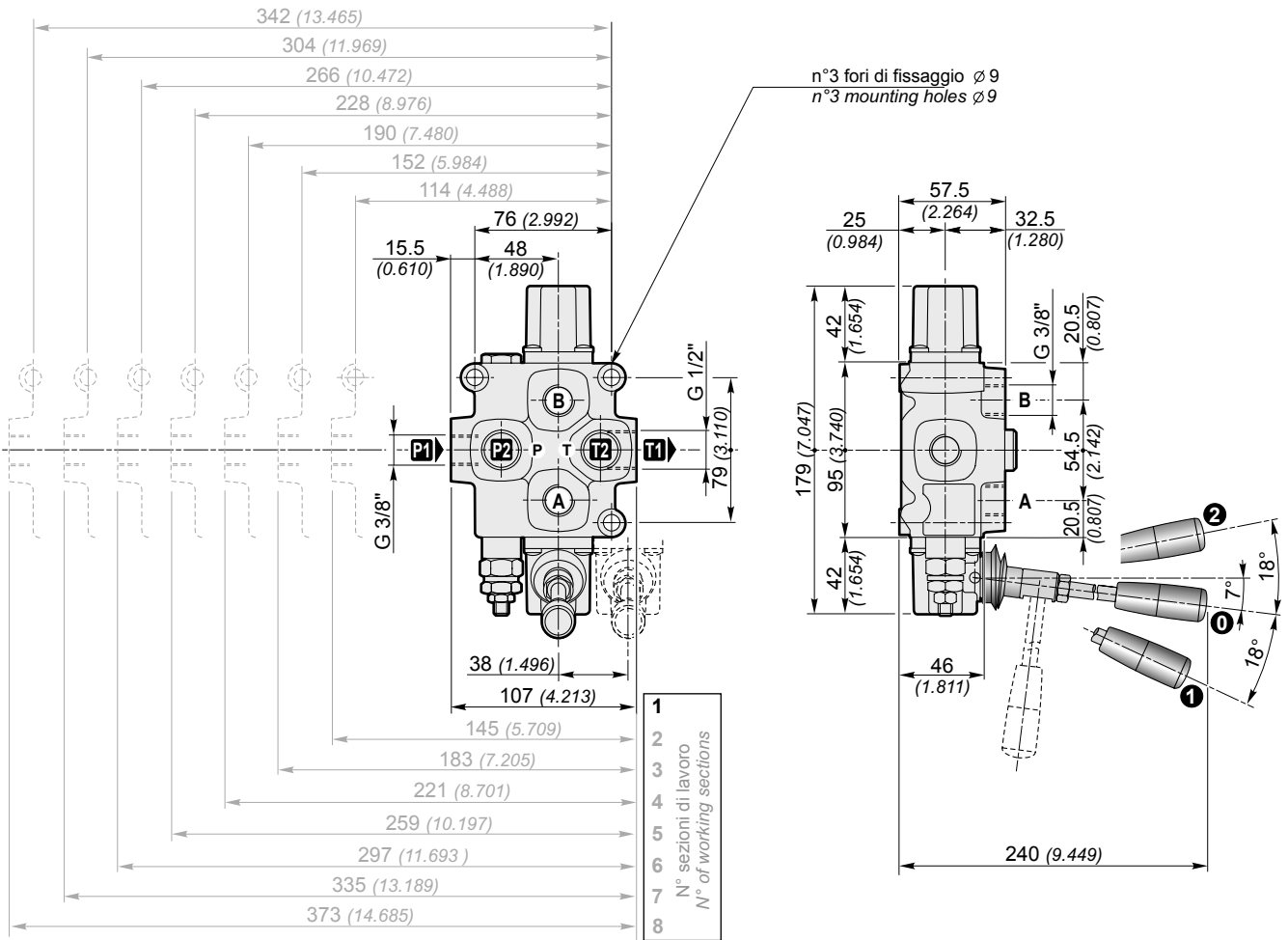

Filettature disponibili / Available ports

Bocche Ports	BSP (standard)	SAE
<b>P1</b>	G 3/8"	9/16" - 18UNF (SAE 6)
<b>P2</b>	G 3/8"	9/16" - 18UNF (SAE 6)
<b>A-B</b>	G 3/8"	9/16" - 18UNF (SAE 6)
<b>T1</b>	G 1/2"	7/8" - 14UNF (SAE 10)
<b>T2</b>	G 3/8"	9/16" - 18UNF (SAE 6)

Tappo per carry-over (su uscita T1)  
Carry-over plug (on T1 port)

	T1	X	
	G 1/2"	7/8"-14UNF (SAE 10)	G 3/8" / G 1/2" / 3/4" - 16UNF (SAE 8)

# Q25

## DISTRIBUTORI MONOBLOCCO MONOBLOCK DIRECTIONAL CONTROL VALVES

**Perdite di carico con il cursore in posizione neutra**  
( $\Delta p$  in funzione del numero di sezioni attraversate)  
**Pressure drop with spool in neutral position**  
( $\Delta p$  depending on the number of the crossed sections)

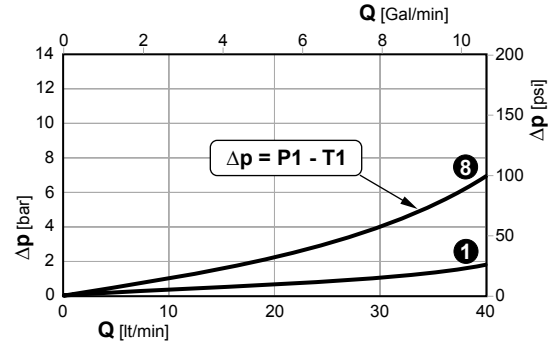
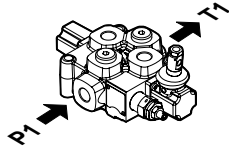

**Perdite di carico con il cursore in posizione di lavoro**  
( $\Delta p$  in funzione del numero di sezioni attraversate)  
**Pressure drop with spool in working position**  
( $\Delta p$  depending on the number of the crossed sections)

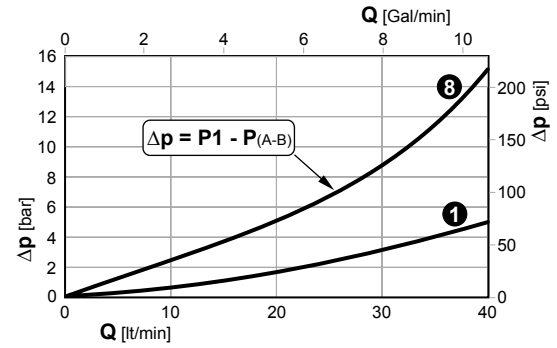
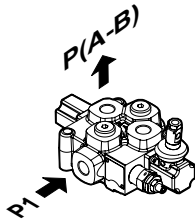

**Perdite di carico con il cursore in posizione di lavoro**  
( $\Delta p$  in funzione del numero di sezioni attraversate)  
**Pressure drop with spool in working position**  
( $\Delta p$  depending on the number of the crossed sections)

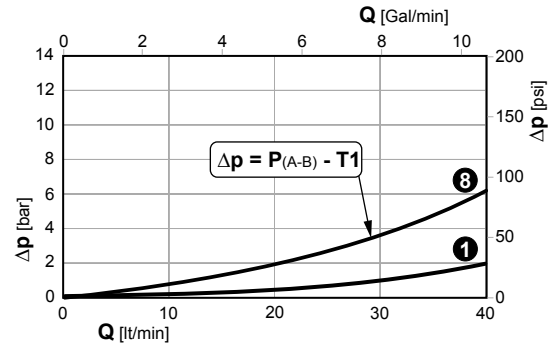
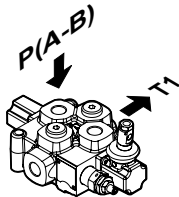

1 8 Sezioni / Sections

**Curve di progressività**  
**Spool metering**

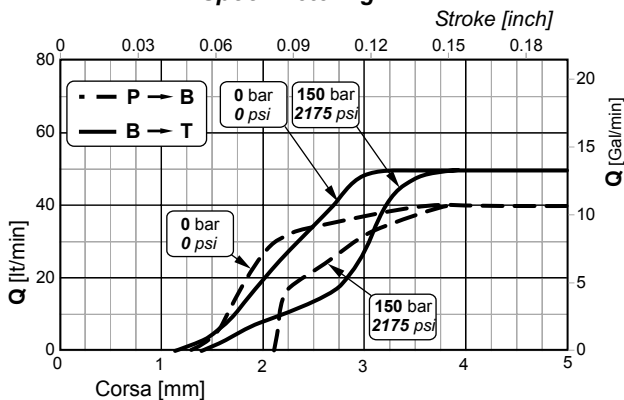

**Trafilamenti sul cursore**  
**Spool leakage**

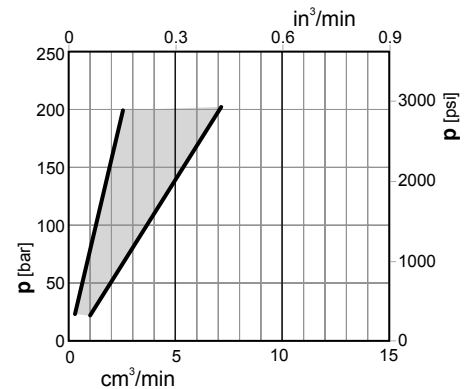

N.B. Le curve sono ricavate con cursore 103 / NOTE. Performance curves measured using spool 103 type.



# Q45

## DISTRIBUTORI MONOBLOCCO MONOBLOCK DIRECTIONAL CONTROL VALVES

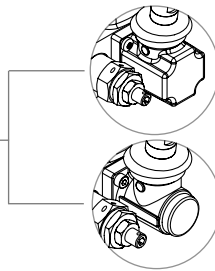
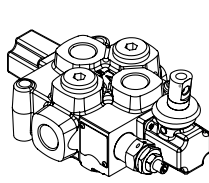

(Standard)  
Comando e posizionate in plastica  
Control and positionner plastic

**S**  
Comando e posizionate in Alluminio  
Control and positionner Aluminium

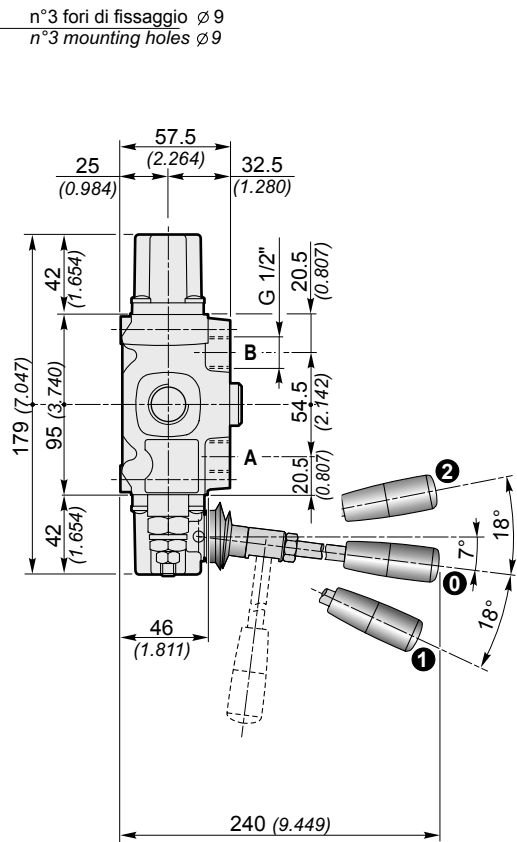
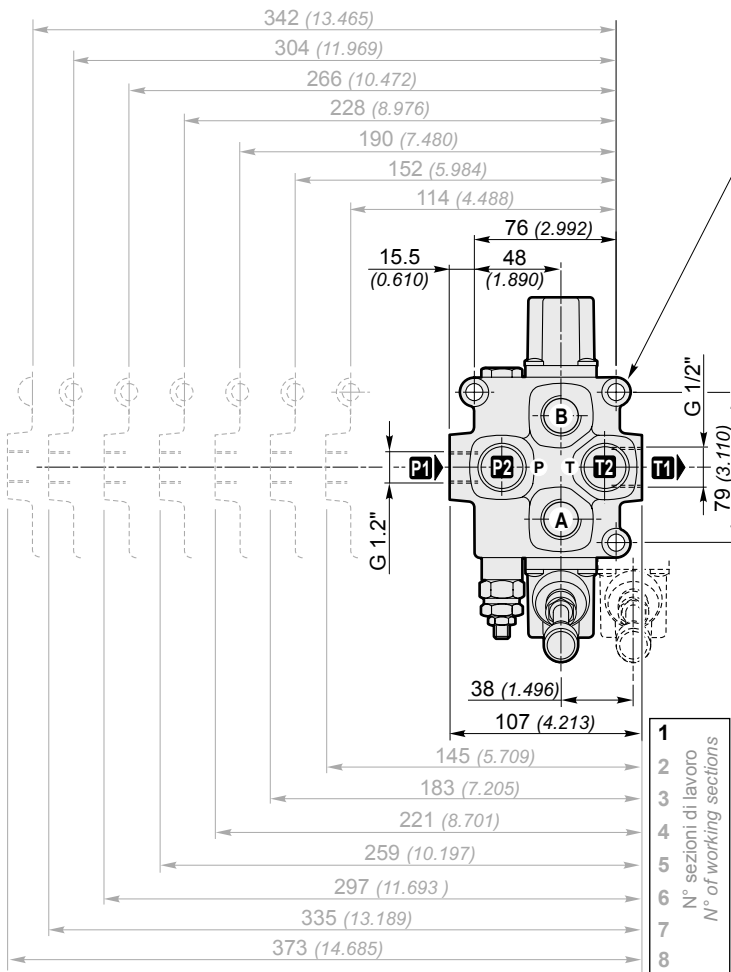
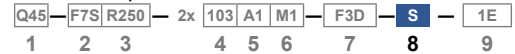

n°3 fori di fissaggio  $\varnothing 9$   
n°3 mounting holes  $\varnothing 9$

- 1
  - 2
  - 3
  - 4
  - 5
  - 6
  - 7
  - 8
- N° sezioni di lavoro  
N° of working sections

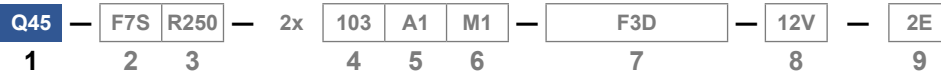

Filettature disponibili / Available ports

Bocche Ports	BSP (standard)	SAE
<b>P1</b>	G 1/2"	3/4" - 16 UNF (SAE 8)
<b>P2</b>	G 1/2"	3/4" - 16 UNF (SAE 8)
<b>A-B</b>	G 1/2"	3/4" - 16 UNF (SAE 8)
<b>T1</b>	G 1/2"	7/8" - 14 UNF (SAE 10)
<b>T2</b>	G 1/2"	3/4" - 16 UNF (SAE 8)

Tappe per carry-over (su uscita T1)  
Carry-over plug (on T1 port)

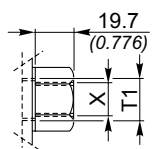
	T1	X	
	G 1/2"	7/8"-14UNF (SAE 10)	G 3/8" / 7/8" - 14UNF (SAE 10)
		G 3/8" / G 1/2"	3/4" - 16UNF (SAE 8)

# Q45

## DISTRIBUTORI MONOBLOCCO MONOBLOCK DIRECTIONAL CONTROL VALVES

**Perdite di carico con il cursore in posizione neutra**  
( $\Delta p$  in funzione del numero di sezioni attraversate)  
**Pressure drop with spool in neutral position**  
( $\Delta p$  depending on the number of the crossed sections)

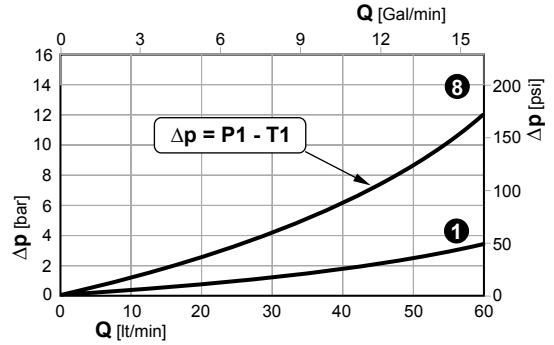
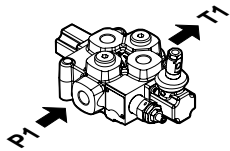

**Perdite di carico con il cursore in posizione di lavoro**  
( $\Delta p$  in funzione del numero di sezioni attraversate)  
**Pressure drop with spool in working position**  
( $\Delta p$  depending on the number of the crossed sections)

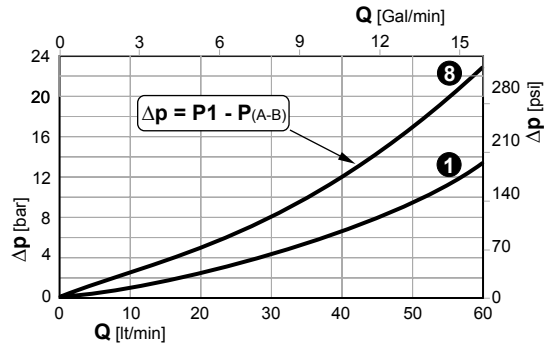
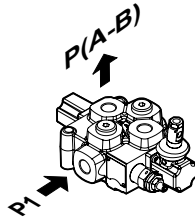

**Perdite di carico con il cursore in posizione di lavoro**  
( $\Delta p$  in funzione del numero di sezioni attraversate)  
**Pressure drop with spool in working position**  
( $\Delta p$  depending on the number of the crossed sections)

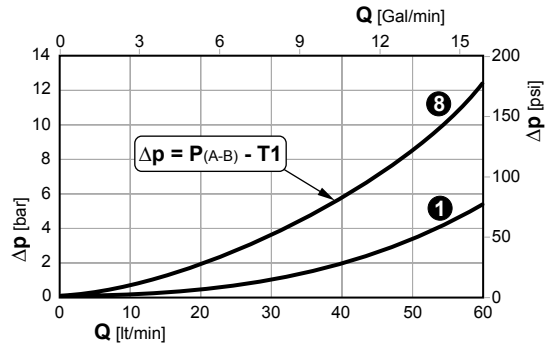
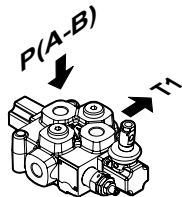

1 8 Sezioni / Sections

**Curve di progressività**  
**Spool metering**

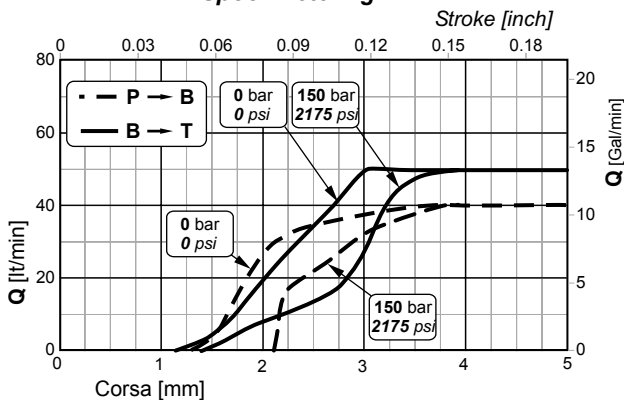

**Trafilamenti sul cursore**  
**Spool leakage**

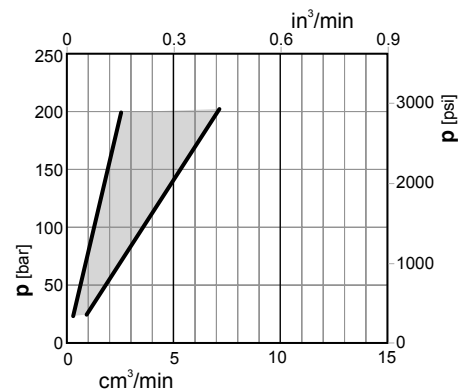

N.B. Le curve sono ricavate con cursore 103 / NOTE. Performance curves measured using spool 103 type.

**Q65**

**DISTRIBUTORI MONOBLOCCO  
MONOBLOCK DIRECTIONAL CONTROL VALVES**

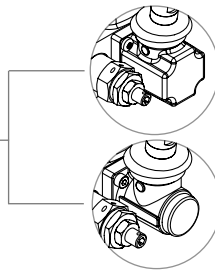
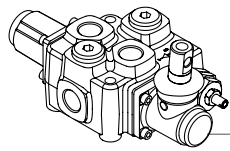

(Standard)  
Comando e posizionate in plastica  
*Control and positionner plastic*

**S**  
Comando e posizionate in Alluminio  
*Control and positionner Aluminium*

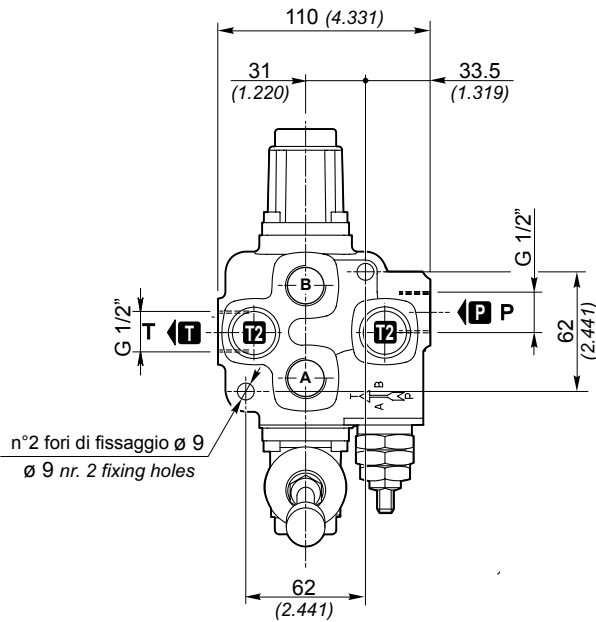

n°2 fori di fissaggio ø 9  
ø 9 nr. 2 fixing holes

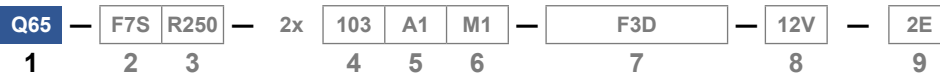
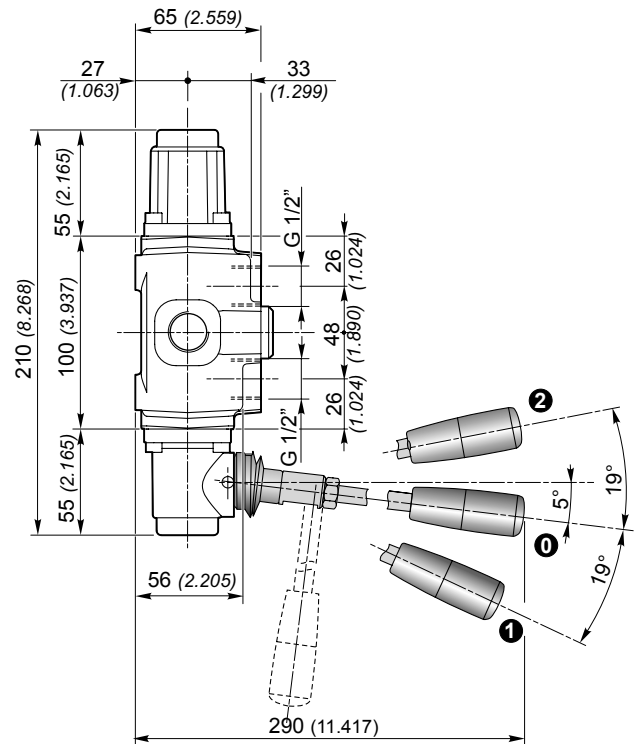

Filettature disponibili / Available ports

Bocche Ports	BSP (standard)	SAE
<b>P1</b>	G 1/2"	7/8" - 14 UNF (SAE 10)
<b>P2</b>	G 1/2"	7/8" - 14 UNF (SAE 10)
<b>A-B</b>	G 1/2"	7/8" - 14 UNF (SAE 10)
<b>T1</b>	G 1/2"	7/8" - 14 UNF (SAE 10)
<b>T2</b>	G 1/2"	7/8" - 14 UNF (SAE 10)

Tappo per carry-over (su uscita T1)  
Carry-over plug (on T1 port)

	T1	X
	G 1/2"	G 3/8"
	7/8"-14UNF (SAE 10)	3/4" - 16UNF (SAE 8) 7/8" - 14UNF (SAE 10)

# Q65

## DISTRIBUTORI MONOBLOCCO MONOBLOCK DIRECTIONAL CONTROL VALVES

**Perdite di carico con il cursore in posizione neutra**  
( $\Delta p$  in funzione del numero di sezioni attraversate)  
**Pressure drop with spool in neutral position**  
( $\Delta p$  depending on the number of the crossed sections)

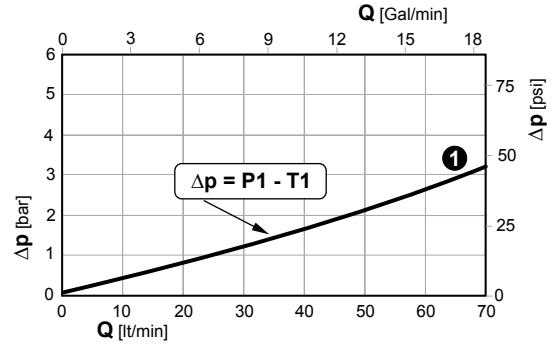
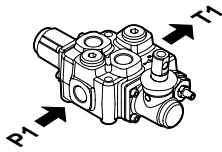

**Perdite di carico con il cursore in posizione di lavoro**  
( $\Delta p$  in funzione del numero di sezioni attraversate)  
**Pressure drop with spool in working position**  
( $\Delta p$  depending on the number of the crossed sections)

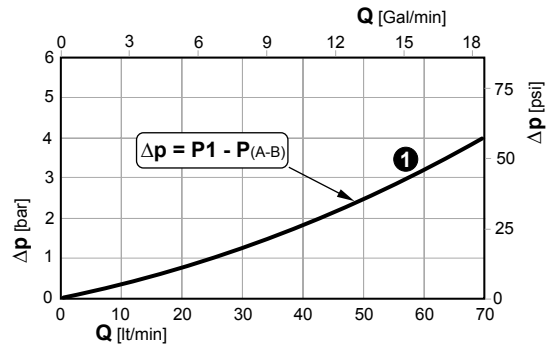
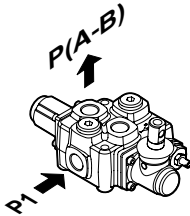

**Perdite di carico con il cursore in posizione di lavoro**  
( $\Delta p$  in funzione del numero di sezioni attraversate)  
**Pressure drop with spool in working position**  
( $\Delta p$  depending on the number of the crossed sections)

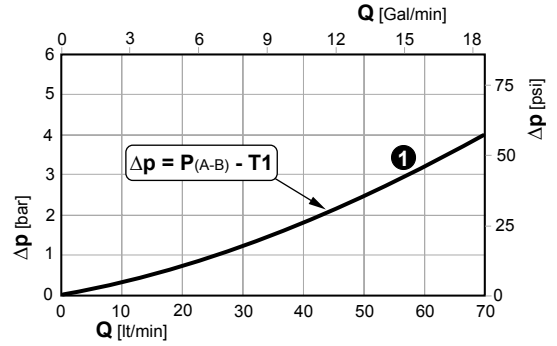
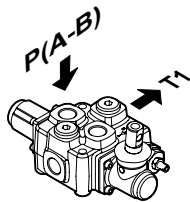

1 Sezioni / Sections

**Curve di progressività**  
**Spool metering**

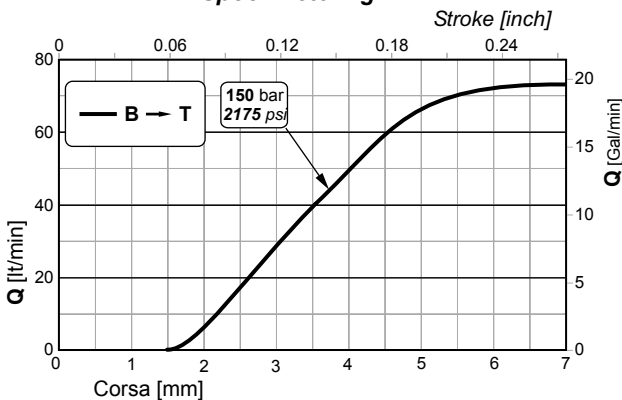

**Trafilamenti sul cursore**  
**Spool leakage**

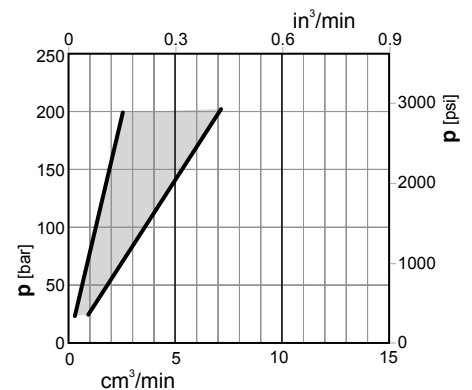

N.B. Le curve sono ricavate con cursore 103 / NOTE. Performance curves measured using spool 103 type.

**Q75**

**DISTRIBUTORI MONOBLOCCO  
MONOBLOCK DIRECTIONAL CONTROL VALVES**

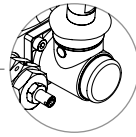
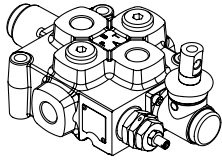

(Standard)  
Comando e posizionatore in Alluminio  
Control and positioner Aluminium

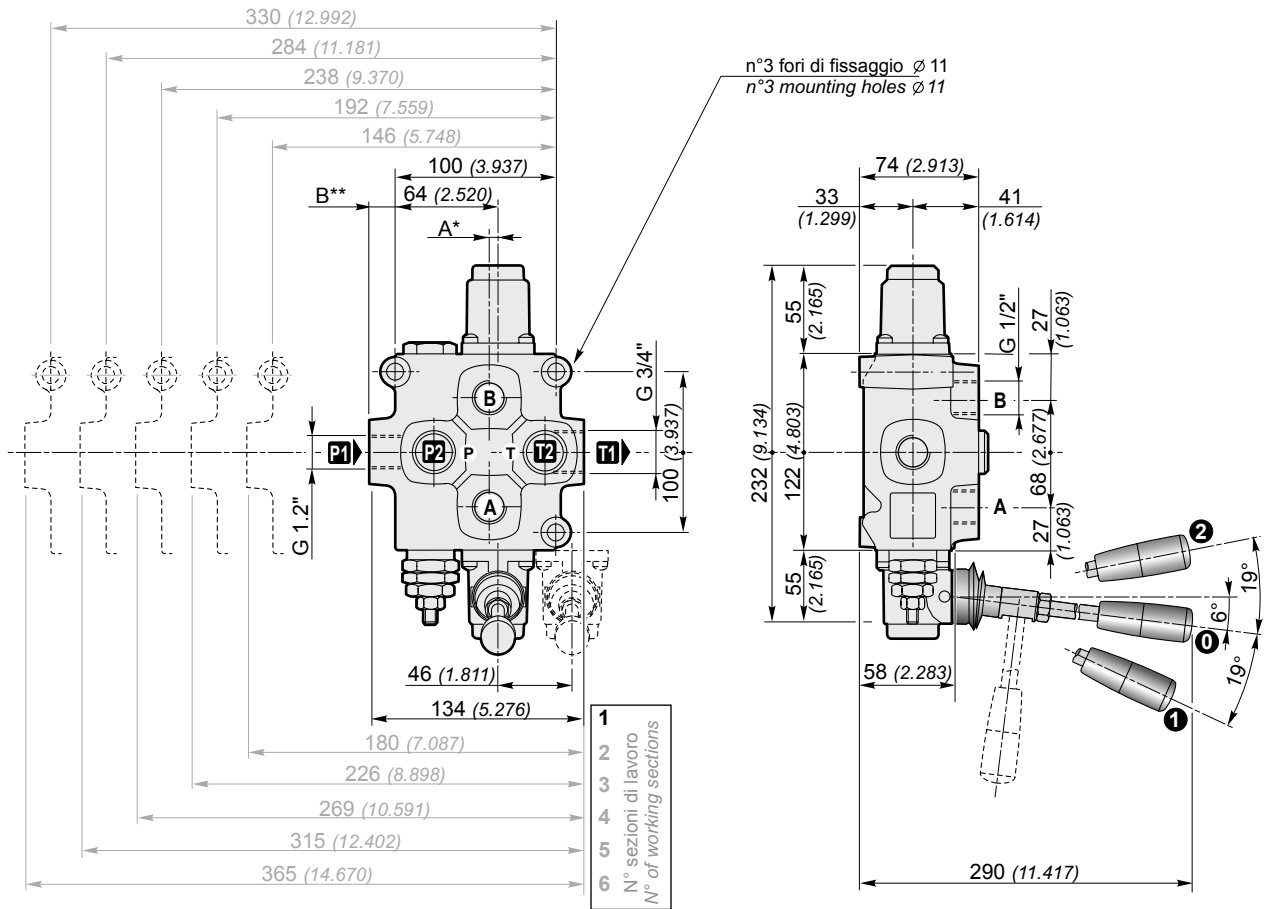

- \* **A=5.5** per monoblocco ad 1 sezione, **A=0** per monoblocchi a 2, 3, 4, 5, 6 sezioni di lavoro
- \* **A =5.5 for 1 working section, A=0 for 2, 3, 4, 5 and 6 working sections**
- \*\* **B=16** per monoblocco ad 1, 2, 3, 6 sezioni, **B=13** per monoblocchi a 4 e 5 sezioni di lavoro
- \*\* **B=16 for 1, 2, 3, 6 working section, B=13 for 4 and 5 working sections**

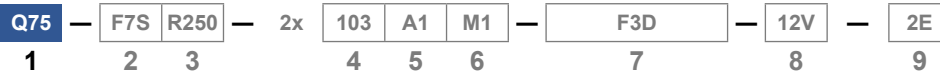

Filettature disponibili / Available ports

Bocche Ports	BSP (standard)	SAE
<b>P1</b>	G 1/2"	7/8" - 14 UNF (SAE 10)
<b>P2</b>	G 1/2"	7/8" - 14 UNF (SAE 10)
<b>A-B</b>	G 1/2"	7/8" - 14 UNF (SAE 10)
<b>T1</b>	G 3/4"	1" 1/16" - 12 UN (SAE 12)
<b>T2</b>	G 1/2"	7/8" - 14 UNF (SAE 10)

Tappo per carry-over (su uscita T1)  
Carry-over plug (on T1 port)

		T1	X	
	G 3/4"	1" 1/16" - 12 UN (SAE 12)	G 1/2"	7/8" - 14 UNF (SAE 10)
			G 3/4"	

# Q75

## DISTRIBUTORI MONOBLOCCO MONOBLOCK DIRECTIONAL CONTROL VALVES

**Perdite di carico con il cursore in posizione neutra**  
( $\Delta p$  in funzione del numero di sezioni attraversate)  
**Pressure drop with spool in neutral position**  
( $\Delta p$  depending on the number of the crossed sections)

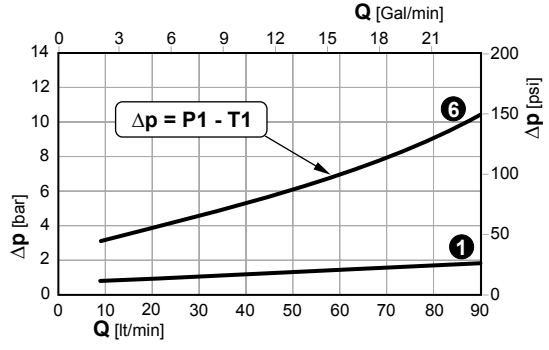
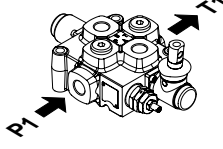

**Perdite di carico con il cursore in posizione di lavoro**  
( $\Delta p$  in funzione del numero di sezioni attraversate)  
**Pressure drop with spool in working position**  
( $\Delta p$  depending on the number of the crossed sections)

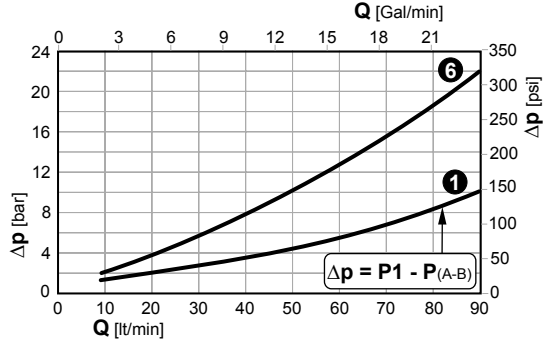
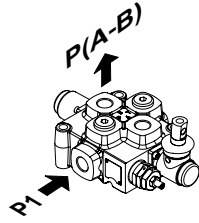

**Perdite di carico con il cursore in posizione di lavoro**  
( $\Delta p$  in funzione del numero di sezioni attraversate)  
**Pressure drop with spool in working position**  
( $\Delta p$  depending on the number of the crossed sections)

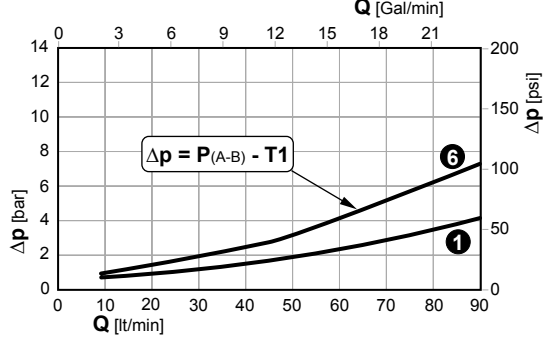
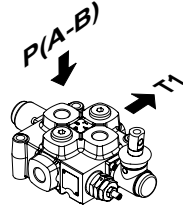

1 6 Sezioni / Sections

**Curve di progressività**  
**Spool metering**

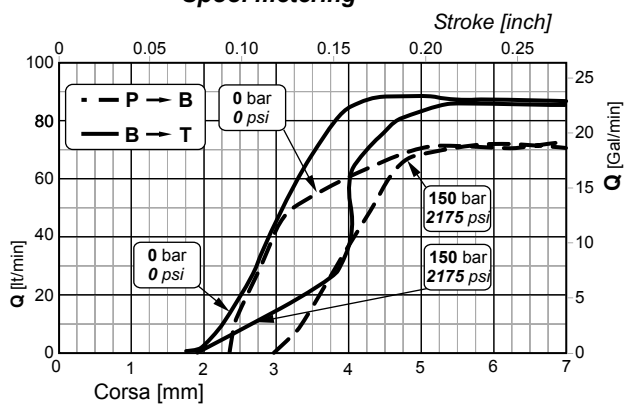

**Trafilamenti sul cursore**  
**Spool leakage**

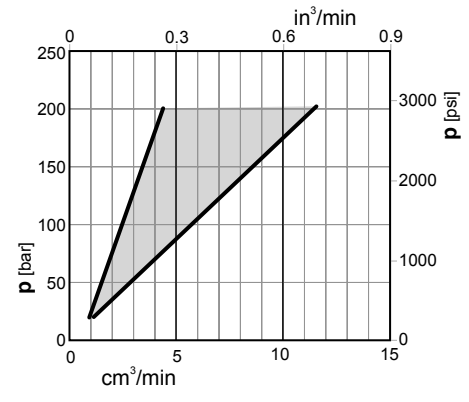

N.B. Le curve sono ricavate con cursore 103 / NOTE. Performance curves measured using spool 103 type.

**Q95**

**DISTRIBUTORI MONOBLOCCO  
MONOBLOCK DIRECTIONAL CONTROL VALVES**

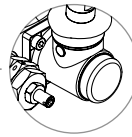
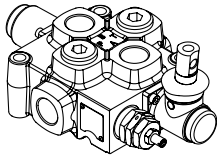

(Standard)  
Comando e posizionatore in Alluminio  
Control and positioner Aluminium

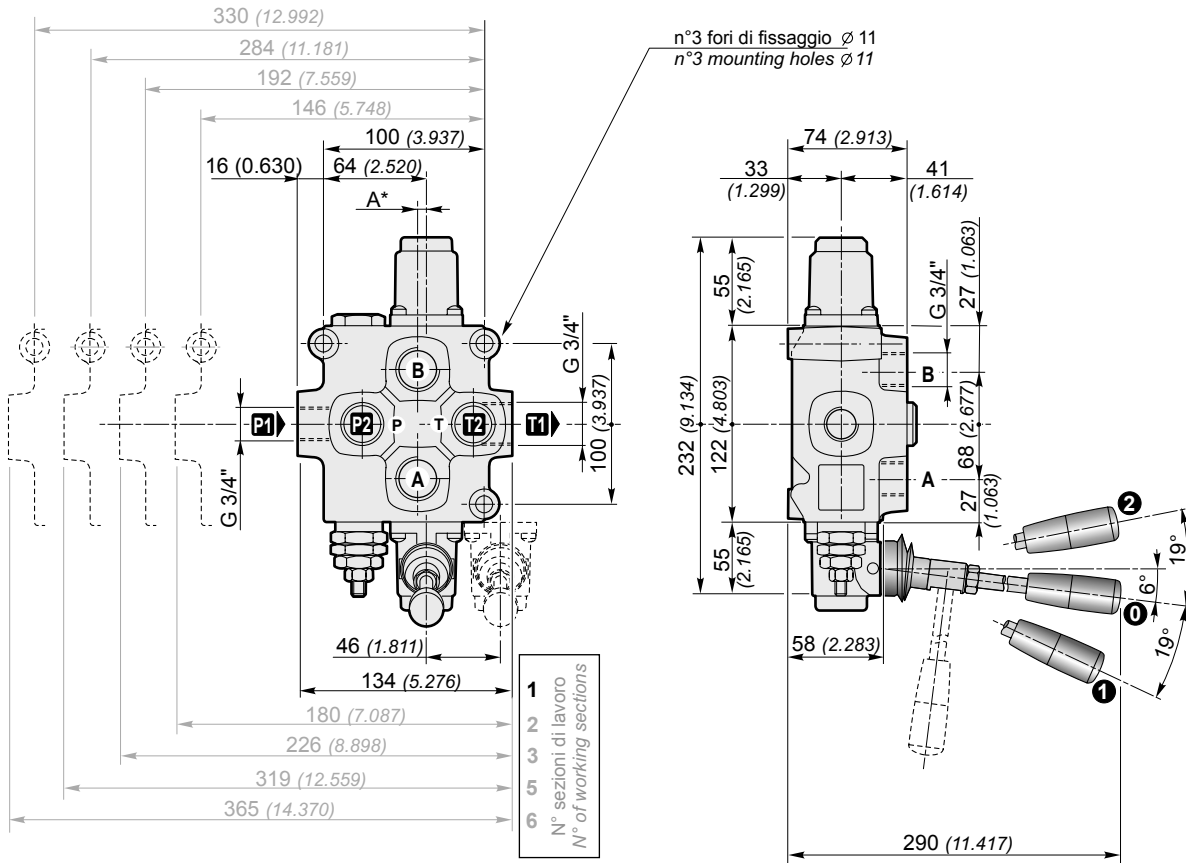

\* **A= 5.5** per monoblocco a 1 sezione; **A=0** per monoblocco a 2-3-5-6 sezioni di lavoro  
\* **A= 5.5** for 1 working section, **A=0** for 2-3-5-6 working section



Filettature disponibili / Available ports

Bocche Ports	BSP (standard)	SAE
<b>P1</b>	G 3/4"	1" 1/16" - 12 UN (SAE 12)
<b>P2</b>	G 3/4"	1" 1/16" - 12 UN (SAE 12)
<b>A-B</b>	G 3/4"	1" 1/16" - 12 UN (SAE 12)
<b>T1</b>	G 3/4"	1" 1/16" - 12 UN (SAE 12)
<b>T2</b>	G 3/4"	1" 1/16" - 12 UN (SAE 12)

Tappo per carry-over (su uscita T1)  
Carry-over plug (on T1 port)

T1		X	
G 3/4"	1" 1/16" - 12 UN (SAE 12)	G 3/4"	7/8" - 14 UNF (SAE 10)



# Q95

## DISTRIBUTORI MONOBLOCCO MONOBLOCK DIRECTIONAL CONTROL VALVES

**Perdite di carico con il cursore in posizione neutra**  
( $\Delta p$  in funzione del numero di sezioni attraversate)  
**Pressure drop with spool in neutral position**  
( $\Delta p$  depending on the number of the crossed sections)

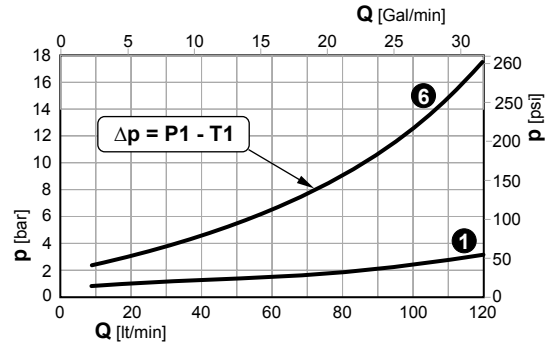
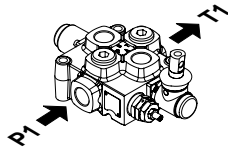

**Perdite di carico con il cursore in posizione di lavoro**  
( $\Delta p$  in funzione del numero di sezioni attraversate)  
**Pressure drop with spool in working position**  
( $\Delta p$  depending on the number of the crossed sections)

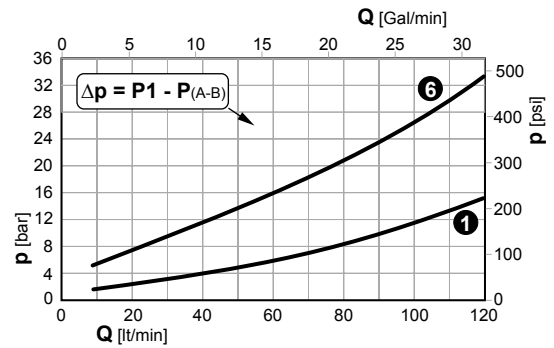
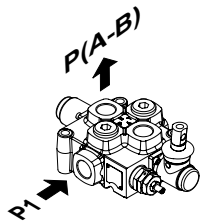

**Perdite di carico con il cursore in posizione di lavoro**  
( $\Delta p$  in funzione del numero di sezioni attraversate)  
**Pressure drop with spool in working position**  
( $\Delta p$  depending on the number of the crossed sections)

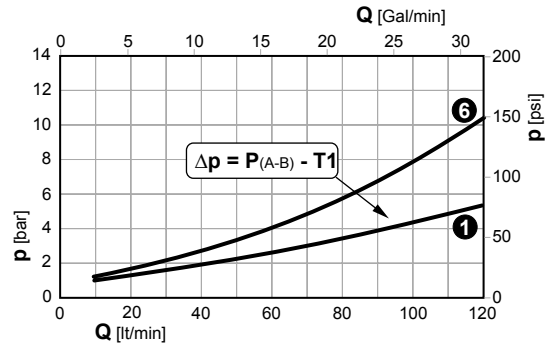
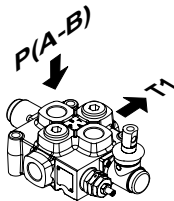

1 6 Sezioni / Sections

**Curve di progressività**  
**Metering spool**

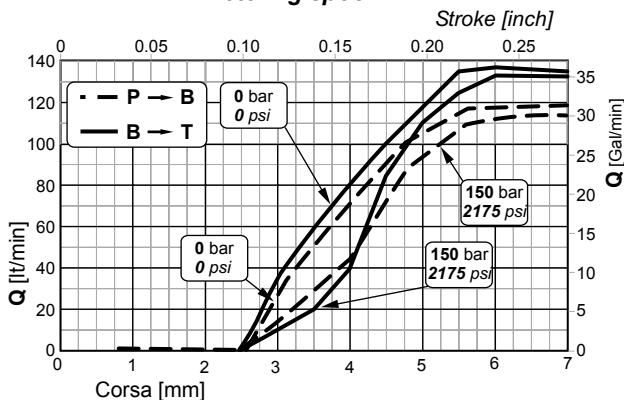

**Trafilamenti sul cursore**  
**Spool leakage**

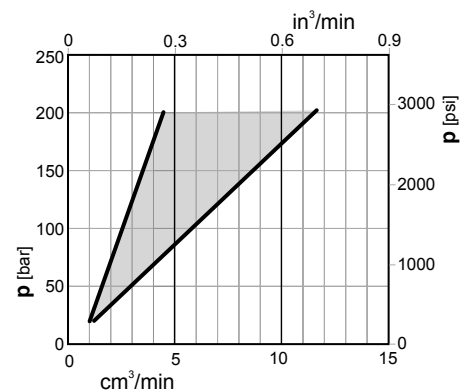

N.B. Le curve sono ricavate con cursore 103 / NOTE. Performance curves measured using spool 103 type.

**Fiancata d'ingresso**

**Inlet section**

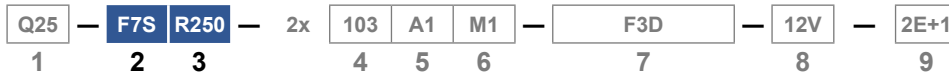

**2 - Tipo fiancata d'ingresso / Inlet section type**

		Q35	Q15	Q25	Q45	Q65	Q75	Q95
<b>F1S</b>	Collettore di entrata con valvola di ritegno VR e valvola limitatrice di pressione VLP			•	•		•	•
<b>F2S</b>	Collettore di entrata con valvola di ritegno VR			•	•		•	•
<b>F7S</b>	Collettore di entrata con valvola limitatrice di pressione VLP	•	•	•	•	•	•	•
<b>F8S</b>	Collettore di entrata senza valvole VLP e VR	•	•	•	•	•	•	•

**F1S** F1S/SAE

Collettore di entrata con valvola di ritegno VR e valvola limitatrice di pressione VLP  
*Inlet section with check (VR) and relief valves VLP*

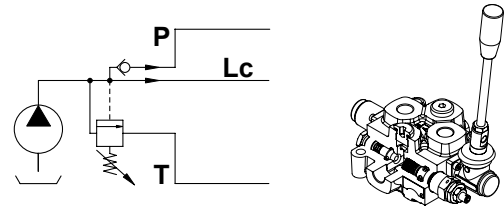

**F7S**

Collettore di entrata con valvola limitatrice di pressione VLP  
*Inlet section with relief valve VLP*

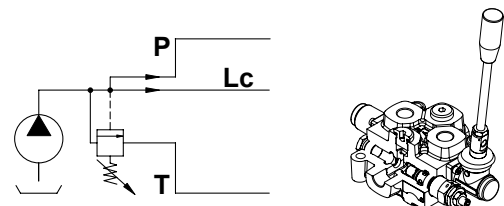

**3 - Tipo molla e taratura valvola**

Dove è presente la valvola VLP (fiancate F1S e F7S), deve essere specificato il tipo di molla (**B**, **N** o **R**) e la sua pressione di taratura; **se quest'ultima viene omessa, verrà messa la molla N tarata a 150 bar.**

**3 - Type of spring and valve setting**

*If valve VLP is installed (inlet section F1S and F7S), specify the type of spring (B, N or R) and its pressure setting. If omitted, spring N with a 150 bar setting will be installed.*

		molla bianca white spring	molla nera black spring	molla rossa red spring
<b>R</b>	Tipo di molla per la VLP Type of spring for relief valve	<b>B</b>	<b>N</b>	<b>R</b>
		Campi di taratura / Calibration fields bar (psi)		
<b>250</b>	Taratura della VLP VLP Setting	10 ÷ 80 (145 ÷ 1160)	81 ÷ 200 (1175 ÷ 2900)	201 ÷ 380 (2915 ÷ 5510)

**F2S**

Collettore di entrata con valvola di ritegno VR  
*Inlet sections with check valve VR*

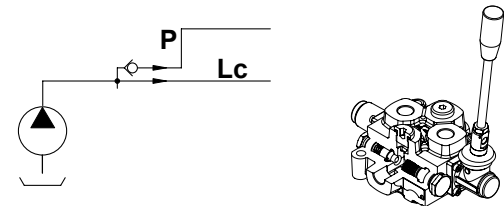

**F8S**

Collettore di entrata senza valvole  
*Inlet section without valves*

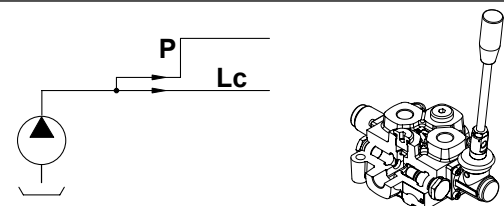

Sezione di lavoro

Working section

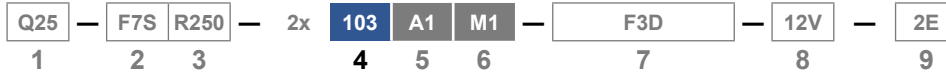

4 - Tipo cursore / Spool type

Cursori / Spools

			Q35	Q15	Q25	Q45	Q65	Q75	Q95
101	Semplice effetto in A	Single acting in A port	•	•	•	•	•	•	•
102	Semplice effetto in B	Single acting in B port	•	•	•	•	•	•	•
103	Doppio effetto, A e B chiusi in posizione 0	Double acting A and B closed in 0 position	•	•	•	•	•	•	•
103RN	Doppio effetto a ricoprimento negativo	Double acting with negative overlap	•						
106	Doppio effetto, passaggi chiusi in posizione 0	Double acting, ports closed in 0 position			•	•		•	•
107	Doppio effetto, A in T e B chiuso in posizione 0	Double acting, A to T and B closed in 0 position			•	•		•	•
108	Doppio effetto, B in T e A chiuso in posizione 0	Double acting, B to T and A closed in 0 position			•	•		•	•
109	Semplice effetto in A, A in T in posizione 0	Single acting in A, A to T in 0 position			•	•		•	•
110	Semplice effetto in B, B in T in posizione 0	Single acting in B, B to T in 0 position			•	•		•	•
111	Doppio effetto, A e B in T in posizione 0	Double acting, A and B to T in 0 position	•	•	•	•	•	•	•
114	Doppio effetto, A e B in T e Lc chiusa in posizione 0	Double acting, A and B to T and through passage closed in 0 position			•	•		•	•
116*	Doppio effetto con 4ª posizione flottante	Double acting with 4th position floating		•	•	•		•	•
126*	Doppio effetto con 4ª posizione flottante	Double acting with 4th position floating		•	•	•		•	•

\* Limitazioni / Limitations

Cursore Spools	Applicabile con: / Applicable with:	
	Comando / Control	Posizionatore / Positioner
116	A1-Z1 / A2-Z1 / A4-Z1 / A6-Z1 / A8-Z1	R8
126	A1 / A2 / A4 / A5 / A6 / A8 / SL / SLA15 / A15 / A16	R10-Z1

**101**

Semplice effetto in A  
Single acting in A port

Q25-Q45  
Q75-Q95

Q15  
Q35  
Q65

**103RN**

Doppio effetto a ricoprimento negativo  
Double acting with negative overlap

**102**

Semplice effetto in B  
Single acting in B port

Q25-Q45  
Q75-Q95

Q15  
Q35  
Q65

**106**

Doppio effetto, passaggi chiusi in posizione 0  
Double acting, ports closed in 0 position

**103**

Doppio effetto, A e B chiusi in posizione 0  
Double acting, A and B closed in 0 position

Q25-Q45  
Q75-Q95

Q15  
Q35  
Q65

**107**

Doppio effetto, A in T e B chiuso in posizione 0  
Double acting, A to T and B closed in 0 position

Sezione di lavoro

Working section

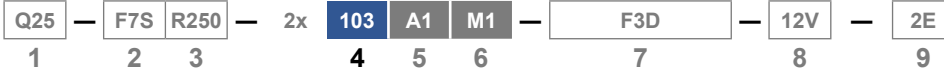

Cursori / Spools

108

Doppio effetto, B in T e A chiuso in posizione 0  
 Double acting, B to T and A closed in 0 position

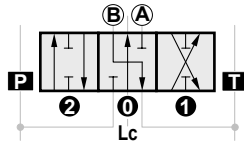

114

Doppio effetto, A e B in T e Lc chiusa in posizione 0  
 Double acting, A and B to T and through passage closed in 0 position

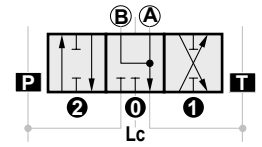

109

Semplice effetto in A, A in T in posizione 0  
 Single acting in A, A to T in 0 position

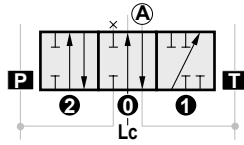

116

Doppio effetto con 4ª posizione flottante  
 Double acting with 4th position floating

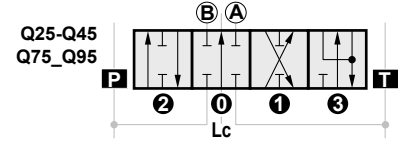

110

Semplice effetto in B, B in T in posizione 0  
 Single acting in B, B to T in 0 position

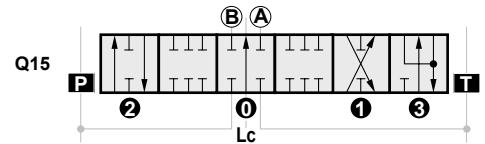
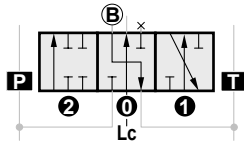

126

Doppio effetto con 4ª posizione flottante  
 Double acting with 4th position floating

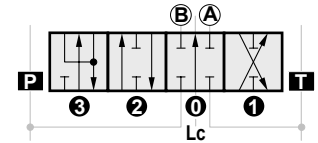

111

Doppio effetto, A e B in T in posizione 0  
 Double acting, A and B to T in 0 position

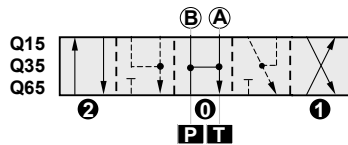
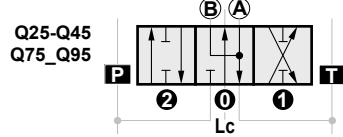

Sezione di lavoro

Working section

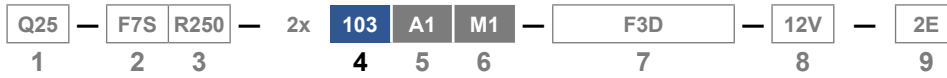

Cursori sensibilizzati / Sensitized spools

Q35	Q25	Q45	Q75	Q95
-----	-----	-----	-----	-----

101.20	Semplice effetto in A	Single acting in A port		•	•	•	•
102.20	Semplice effetto in B	Single acting in B port		•	•	•	•
103.05	Doppio effetto, A e B chiusi in posizione 0	Double acting, A and B closed in 0 position		•	•	•	•
103.10	Doppio effetto, A e B chiusi in posizione 0	Double acting, A and B closed in 0 position				•	•
103.20	Doppio effetto, A e B chiusi in posizione 0	Double acting, A and B closed in 0 position		•	•		
103.25	Doppio effetto, A e B chiusi in posizione 0	Double acting, A and B closed in 0 position		•	•		
103.30	Doppio effetto, A e B chiusi in posizione 0	Double acting, A and B closed in 0 position				•	•
103.40	Doppio effetto, A e B chiusi in posizione 0	Double acting, A and B closed in 0 position		•	•		
107.20	Doppio effetto, A in T e B chiuso in posizione 0	Double acting, A to T and B closed in 0 position		•	•		
108.20	Doppio effetto, B in T e A chiuso in posizione 0	Double acting, B to T and A closed in 0 position		•	•		
111.05	Doppio effetto, A e B in T in posizione 0	Double acting, A and B to T in 0 position		•	•		
111.10	Doppio effetto, A e B in T in posizione 0	Double acting, A and B to T in 0 position				•	•
111.20	Doppio effetto, A e B in T in posizione 0	Double acting, A and B to T in 0 position		•	•		
111.25	Doppio effetto, A e B in T in posizione 0	Double acting, A and B to T in 0 position		•	•		
111.30	Doppio effetto, A e B in T in posizione 0	Double acting, A and B to T in 0 position				•	•
111.40	Doppio effetto, A e B in T in posizione 0	Double acting, A and B to T in 0 position		•	•		

101.20

Semplice effetto in A  
Single acting in A port

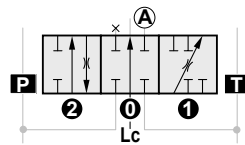

103.20

Doppio effetto, A e B chiusi in posizione 0  
Double acting, A and B closed in 0 position

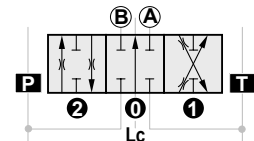

102.20

Semplice effetto in B  
Single acting in B port

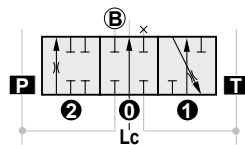

103.25

Doppio effetto, A e B chiusi in posizione 0  
Double acting, A and B closed in 0 position

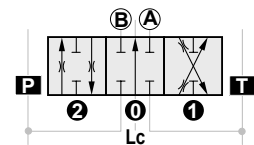

103.05

Doppio effetto, A e B chiusi in posizione 0  
Double acting, A and B closed in 0 position

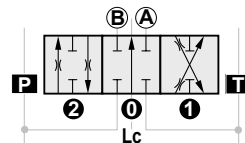

103.30

Doppio effetto, A e B chiusi in posizione 0  
Double acting, A and B closed in 0 position

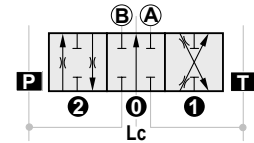

103.10

Doppio effetto, A e B chiusi in posizione 0  
Double acting, A and B closed in 0 position

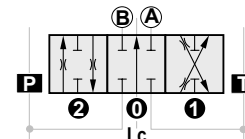

103.40

Doppio effetto, A e B chiusi in posizione 0  
Double acting, A and B closed in 0 position

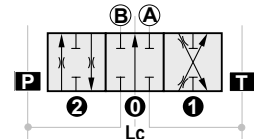

Sezione di lavoro

Working section

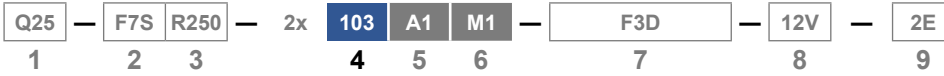

Cursori sensibilizzati / Sensitized spools

107.20

Doppio effetto, A in T e B chiuso in posizione 0  
 Double acting, A to T and B closed in 0 position

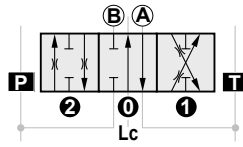

111.20

Doppio effetto, A e B in T in posizione 0  
 Double acting, A and B to T in 0 position

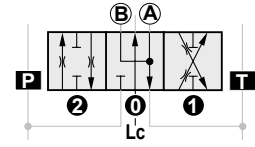

108.20

Doppio effetto, B in T e A chiuso in posizione 0  
 Double acting, B to T and A closed in 0 position

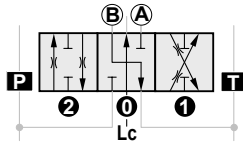

111.25

Doppio effetto, A e B in T in posizione 0  
 Double acting, A and B to T in 0 position

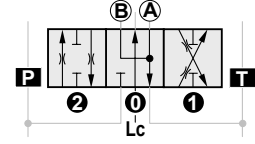

111.05

Doppio effetto, A e B in T in posizione 0  
 Double acting, A and B to T in 0 position

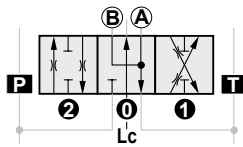

111.30

Doppio effetto, A e B in T in posizione 0  
 Double acting, A and B to T in 0 position

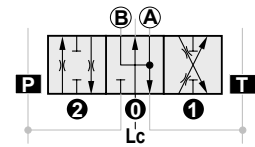

111.10

Doppio effetto, A e B in T in posizione 0  
 Double acting, A and B to T in 0 position

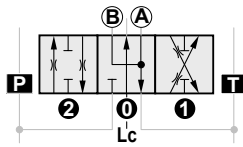

111.40

Doppio effetto, A e B in T in posizione 0  
 Double acting, A and B to T in 0 position

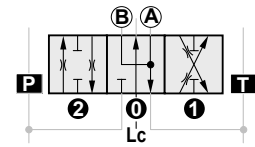

## Sezione di lavoro

## Working section



## 5 - Tipo di comando / Control type

		Q35	Q15	Q25	Q45	Q65	Q75	Q95
<b>A1</b>	Comando manuale con leva standard	•	•	•	•	•	•	•
<b>A1/Z1*</b>	Versione con kit distanziale per il montaggio del cursore 116		•	•			•	•
<b>A2</b>	Comando manuale con leva standard ruotata di 180°		•	•	•	•	•	•
<b>A2/Z1*</b>	Versione con kit distanziale per il montaggio del cursore 116		•	•	•		•	•
<b>A3*</b>	Scatola di protezione in sostituzione del comando manuale con leva			•	•	•	•	•
<b>A4</b>	Attacco diretto sul cursore per rinvio a distanza rigido			•	•	•	•	•
<b>A4/Z1*</b>	Versione con kit distanziale per il montaggio del cursore 116			•	•		•	•
<b>A5</b>	Attacco diretto sul cursore con terminale sferico (da utilizzare solo con il posizionamento M4 (2-1))	•		•	•	•	•	•
<b>A6</b>	Attacco diretto sul cursore con terminale ad occhio fisso	•		•	•	•	•	•
<b>A6/Z1*</b>	Versione con kit distanziale per il montaggio del cursore 116			•	•		•	•
<b>A8</b>	Attacco diretto sul cursore per cavo flessibile rinvio a distanza			•	•	•	•	•
<b>A8/Z1*</b>	Versione con kit distanziale per il montaggio del cursore 116			•	•		•	•
<b>C1*</b>	Cavo flessibile			•	•		•	•
<b>SL*</b>	Comando a distanza			•	•		•	•
<b>SLA15*</b>	Comando a cloche per controllo simultaneo di due cursori a distanza			•	•		•	•

## \* Limitazioni / Limitations

Comando Control	Applicabile con: / Applicable with:	
	Comando / Control	Cursore / Spool
<b>A3</b>	M1-U1 / M2-U1 / M3-U1 / M1-U2 / M2-U2 / M3-U2 / D2 / P1-N / P1-NP / D3	Tutti / All
<b>C1</b>		
<b>SL</b>	A8 / M1U2 - M2U2 - M3U2	
<b>SLA15</b>		

Comando Control	Applicabile con: / Applicable with:	
	Posizionatore / Positioner	Cursore / Spool
<b>A1/Z1</b> <b>A2/Z1</b> <b>A4/Z1</b> <b>A6/Z1</b> <b>A8/Z1</b>	R8	116



Sezione di lavoro

Working section

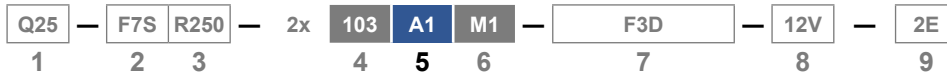

5 - Tipo di comando / Control type

		Q35	Q25	Q45	Q75	Q95
<b>Leva a cloche per il comando singolo o simultaneo di due cursori:</b>						
<i>Dual axis for single or simultaneous control of two spools:</i>						
<b>A15S</b>	- con fulcro a sinistra		•	•	•	•
<b>A15D</b>	- con fulcro a destra		•	•	•	•
<b>A16</b>	- come a schema (pag. F-25)		•	•	•	•
<b>Comando manuale con attivazione del contatto elettrico del microswitch centralizzato:</b>						
<i>Hand control with ON-OFF centralized microswitch operation</i>						
<b>N1-A1</b>	- per doppio effetto		•	•	•	•
<b>N1A-A1</b>	- per semplice effetto in posizione 1		•	•	•	•
<b>N1B-A1</b>	- per semplice effetto in posizione 2		•	•	•	•
<b>Comando manuale, ruotato di 180°, con attivazione del contatto elettrico del microswitch centralizzato:</b>						
<i>180° Rotated hand control with ON-OFF centralized microswitch operation</i>						
<b>N1-A2</b>	- per doppio effetto		•	•	•	•
<b>N1A-A2</b>	- per semplice effetto in posizione 1		•	•	•	•
<b>N1B-A2</b>	- per semplice effetto in posizione 2		•	•	•	•
<b>Comando microswitch centralizzato:</b>						
<i>Centralized microswitch control:</i>						
<b>N1-A3</b>	- per doppio effetto		•	•	•	•
<b>N1A-A3</b>	- per semplice effetto in posizione 1		•	•	•	•
<b>N1B-A3</b>	- per semplice effetto in posizione 2		•	•	•	•

**A1** | **A1/Z1**

A1: Comando manuale con leva standard  
 A1: Hand control with standard lever



A1/Z1: Versione con kit distanziale per il montaggio del cursore 116  
 A1/Z1: Version with spacer kit for installation of spool 116

**A2** | **A2/Z1**

A2: Comando manuale con leva standard ruotata di 180°  
 A2: Hand control with standard lever rotated 180°



A2/Z1: Versione con kit distanziale per il montaggio del cursore 116  
 A2/Z1: Version with spacer kit for installation of spool 116

	A	B	C	D	Z
<b>Q15</b>	35 (1.378)	205 (8.071)	7°	14°	44 (1.732)
<b>Q35</b> <b>Q25 - Q45</b>	42 (1.654)	205 (8.071)	7°	18°	50.5 (1.988)
<b>Q65</b> <b>Q75 - Q95</b>	55 (2.165)	260 (10.236)	6°	19°	68.5 (2.697)

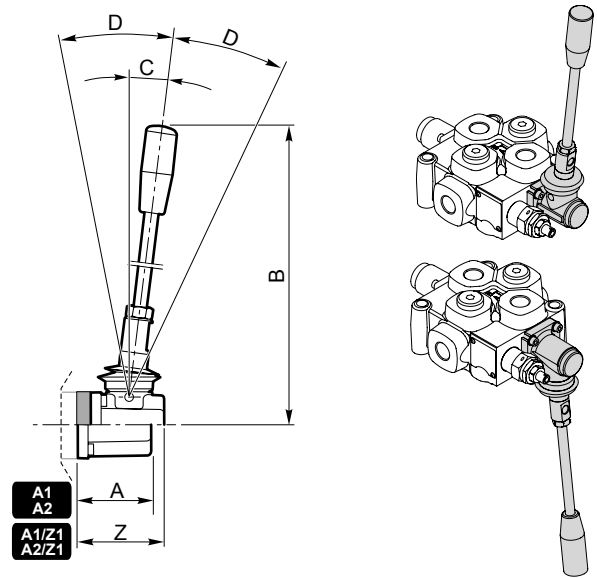

**A3**

Scatola di protezione in sostituzione del comando manuale con leva  
 Proof cap replacing hand control with lever



	A
<b>Q25 - Q45</b>	42 (1.654)
<b>Q75 - Q95</b>	55 (2.165)

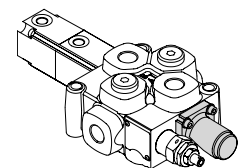

Sezione di lavoro

Working section



A4

A4/Z1

A4: Attacco diretto sul cursore per rinvio a distanza rigido  
 A4: Direct control connection on spool for stiff remote control

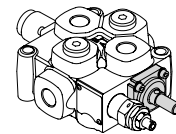
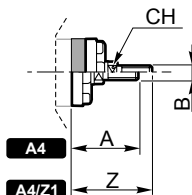
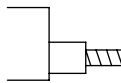

A4/Z1: Versione con kit distanziale per il montaggio del cursore 116  
 A4/Z1: Version with spacer kit for installation of spool 116

	A	B	CH	Corsa Stroke	Z
Q25 - Q45	39 (1.535)	M8	9 (0.354)	±5 (0.197)	47.5 (1.870)
Q65 Q75 - Q95	53 (2.087)	M10	14 (0.551)	±7 (0.276)	66.5 (2.618)

A5

Attacco diretto sul cursore con terminale sferico (da utilizzare solo con il posizionamento M4 (2-1))  
 Direct control connection on spool with spherical end (Control to be used for positioning M4 (2-1))0

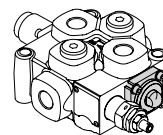
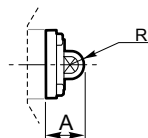
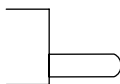

	A	R	Corsa Stroke
Q35 Q25 - Q45	22 (0.866)	6.85 (0.270)	±5 (0.197)
Q65 Q75 - Q95	33 (1.299)	8.75 (0.344)	±7 (0.276)

A6

A6/Z1

A6: Attacco diretto sul cursore con terminale ad occhio fisso  
 A6: Direct control connection on spool eye end

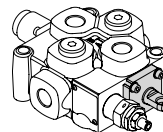
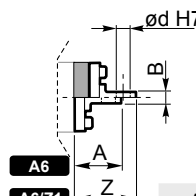
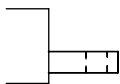

A6/Z1: Versione con kit distanziale per il montaggio del cursore 116  
 A6/Z1: Version with spacer kit for installation of spool 116

	A	B	d	Corsa Stroke	Z
Q35 Q25 - Q45	20 (0.787)	6 (0.236)	9 (0.354)	±5 (0.197)	28.5 (1.122)
Q65 Q75 - Q95	27 (1.063)	7 (0.276)	11 (0.433)	±7 (0.276)	40.5 (1.594)

A8

A8/Z1

A8: Attacco diretto sul cursore per cavo flessibile rinvio a distanza  
 A8: Direct connection on spool for remote flexible control

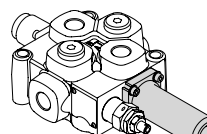
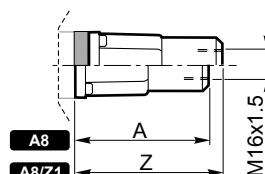
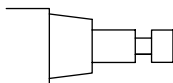

A8/Z1: Versione con kit distanziale per il montaggio del cursore 116  
 A8/Z1: Version with spacer kit for installation of spool 116

	A	Z
Q25 - Q45	73 (2.874)	81.5 (3.209)
Q65 Q75 - Q95	77 (3.031)	90.5 (3.563)

Sezione di lavoro

Working section

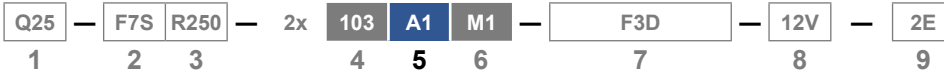

C1

Cavo flessibile  
Flexible cable

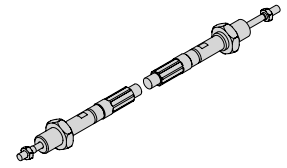
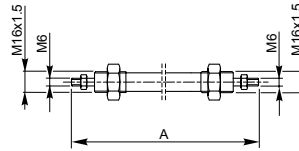
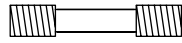

A

Q25 - Q45  
Q75 - Q95

Massima lunghezza cavo consigliata 4000 mm  
Raggio min. di curvatura 200mm  
Max. recommended length 4000 mm  
Minimum radius curve 200 mm

Dove è utilizzato il cavo flessibile C1, è necessario indicare la lunghezza del cavo espressa in mm.  
Esempio per un cavo lungo 1000 mm: **A8-C1x1000-SL**

Indicate the cable length in mm when flexible cable C1 is used.  
E.g.: for a cable 1000 mm in length: **A8-C1x1000-SL**

SL

Comando a distanza  
Remote control

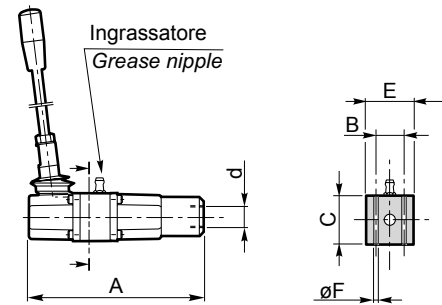
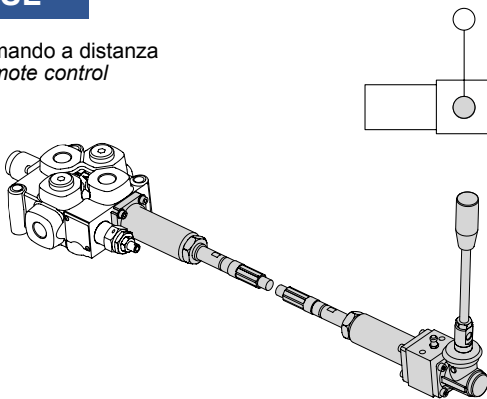

	A	B	C	d	E	F
Q25 - Q45	135 (5.315)	26 (1.024)	40 (1.575)	M16x1.5	38 (1.496)	5.5 (0.217)
Q75 - Q95	172 (6.772)	33.5 (1.319)	45 (1.772)		45 (1.772)	6.5 (0.256)

SLA15

Comando a cloche per controllo  
simultaneo di due cursori a distanza  
Remote dual axis control for  
simultaneous operation of two spools

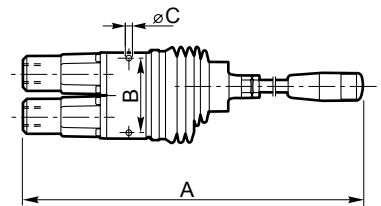
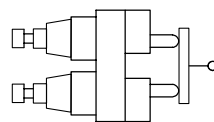

	A	B	Ø d
Q25 - Q45	358 (14.094)	77 (3.031)	6.5 (0.256)
Q75 - Q95			

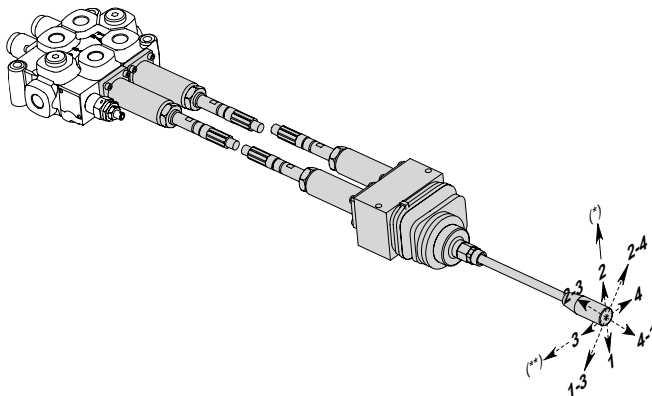

Eventuale cassetto con 4<sup>a</sup> pos. (solo cod.126)  
Optional spool with 4<sup>th</sup> position (only code 126)  
(\* ) su 1<sup>a</sup> sezione / on 1<sup>st</sup> section  
(\*\* ) su 2<sup>a</sup> sezione / on 2<sup>nd</sup> section

Sezione di lavoro

Working section

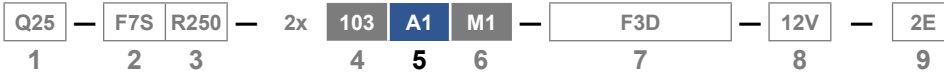

A15..

Leva a cloche per il comando singolo o simultaneo di due cursori, come schema a lato  
 Dual axis for simultaneous or single control of two spools, as from the scheme on the side

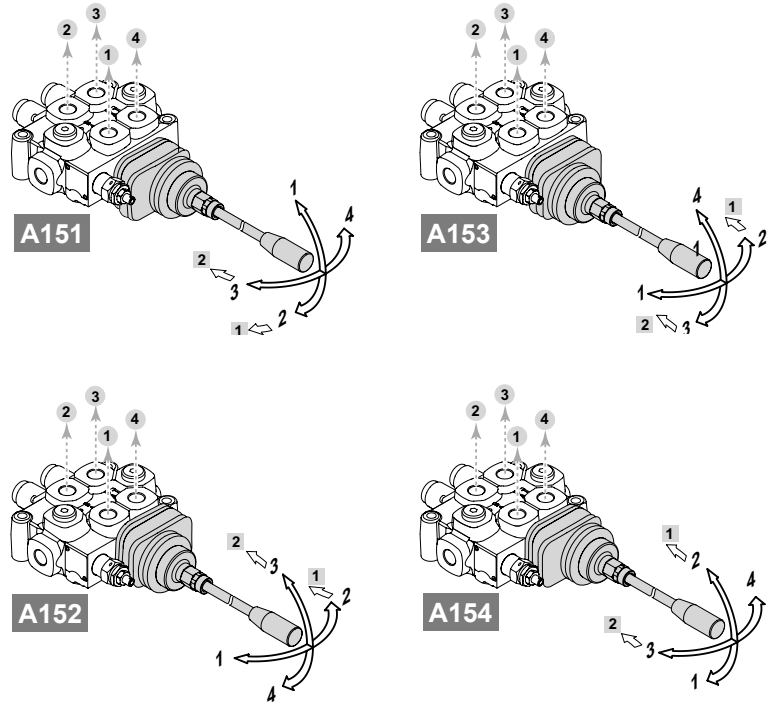
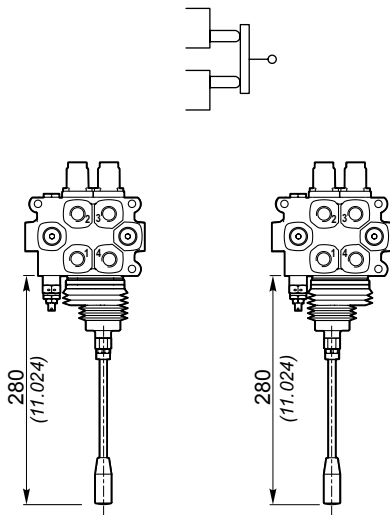

**N.B.** Nelle configurazioni A151 e A153, la parte inferiore del comando sporge dal piano di appoggio.  
 Note: A151 - A153 configurations the smallest size is lower than the bolster.

Eventuale cassetto con 4<sup>a</sup> pos. (solo cod.126)  
 Optional spool with 4th position (only code 126)  
 1 su 1<sup>a</sup> sezione / on 1<sup>st</sup> section  
 2 su 2<sup>a</sup> sezione / on 2<sup>nd</sup> section

A16

Leva a cloche per il controllo singolo o simultaneo di due cursori come schema a lato  
 Dual axis for single or simultaneous control of two spools as from the scheme on the side

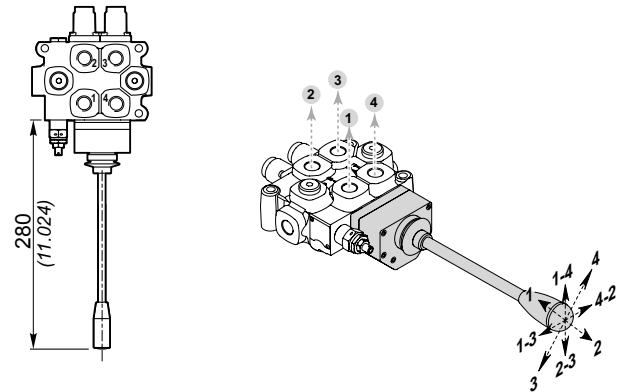
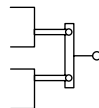

I comandi **A15**, **A16** o **SLA15** sono dei joystick che comandano due sezioni di lavoro; essendo un comando unico viene inserito come codice solo nella prima sezione di lavoro e viene omesso nella seconda.  
 Esempio  
 Q25 - F7SR250 - 103/**A15**/M1 - 103/M1 - F3D  
 Nella seconda sezione di lavoro è indicato solo il cursore e il posizionatore.

Controls **A15**, **A16** or **SLA15** are joysticks that control two working sections. Since it is a single control, it is only entered as a code in the first work section and is omitted from the second.  
 Example  
 Q25 - F7SR250 - 103/**A15**/M1 - 103/M1 - F3D  
 Only the spool and positioner are indicated in the second working section.

Quando è richiesto anche il cavo C1, è necessario specificarne la lunghezza in entrambe le sezioni.  
 Esempio  
 Q25 - F7SR250 - 103/**A8-C1x1000**-SLA15/M1 - 103/**A8-C1x1000**/M1 - F3D

When cable C1 is also required, its length must be specified in both sections.  
 Example  
 Q25 - F7SR250 - 103/**A8-C1x1000**-SLA15/M1 - 103/**A8-C1x1000**/M1 - F3D

Sezione di lavoro

Working section

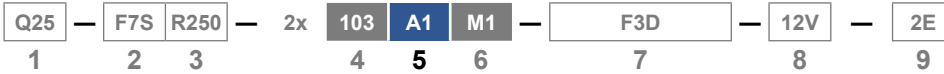

**N1-A1**  
**N1A-A1**  
**N1B-A1**

Comando manuale con attivazione del contatto elettrico del microswitch centralizzato.

- N1-A1: Per doppio effetto
- N1A-A1: Per semplice effetto in pos. 1
- N1B-A1: Per semplice effetto in pos. 2
- Hand control with ON-OFF centralized microswitch operation.*
- N1 -A1: Double acting*
- N1A-A1: Single acting in 1 position*
- N1B-A1: Single acting in 2 position*

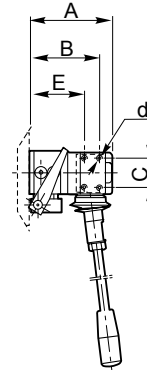
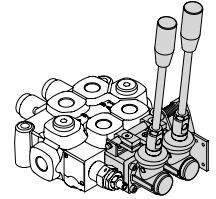
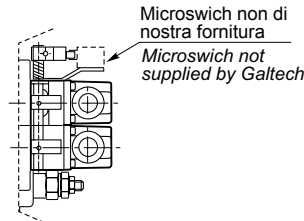
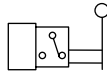

	A	B	C	E	d
<b>Q25 - Q45</b>	70 (2.756)	59	25	49	M4
<b>Q75 - Q95</b>	84 (3.307)	(2.323)	(0.984)	(1.929)	

**N1-A2**  
**N1A-A2**  
**N1B-A2**

Comando manuale ruotato di 180° con attivazione del contatto elettrico del microswitch centralizzato.

- N1-A2: Per doppio effetto
- N1A-A2: Per semplice effetto in pos. 1
- N1B-A2: Per semplice effetto in pos. 2
- 180° rotated hand control with ON-OFF centralized microswitch operation.*
- N1-A2: Double acting*
- N1A-A2: Single acting in 1 position*
- N1B-A2: Single acting in 2 position*

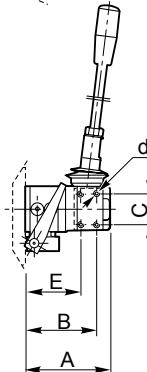
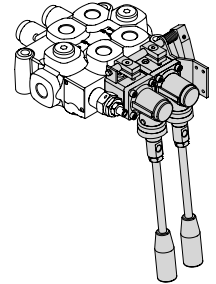
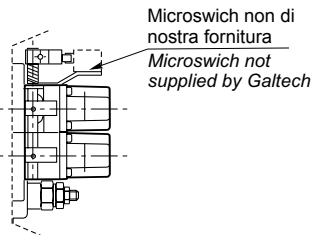
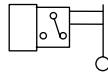

	A	B	C	E	d
<b>Q25 - Q45</b>	70 (2.756)	59	25	49	M4
<b>Q75 - Q95</b>	84 (3.307)	(2.323)	(0.984)	(1.929)	

**N1-A3**  
**N1A-A3**  
**N1B-A3**

Comando microswitch centralizzato.

- N1-A3: Per doppio effetto
- N1A-A3: Per semplice effetto in pos. 1
- N1B-A3: Per semplice effetto in pos. 2
- Centralized microswitch control.*
- N1-A3: Double acting*
- N1A-A3: Single acting in 1 position*
- N1B-A3: Single acting in 2 position*

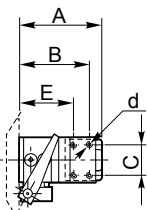
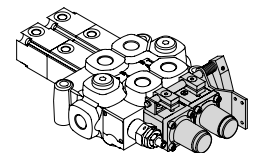
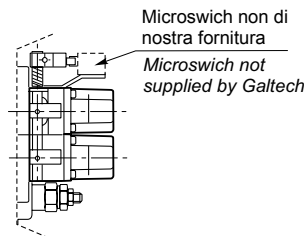
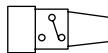

	A	B	C	E	d
<b>Q25 - Q45</b>	70 (2.756)	59	25	49	M4
<b>Q75 - Q95</b>	84 (3.307)	(2.323)	(0.984)	(1.929)	

## Sezione di lavoro

## Working section

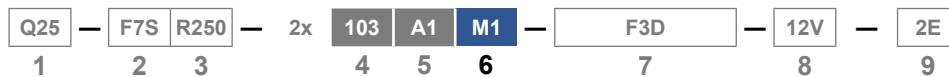

## 6 - Tipo posizionario

\* La posizione dei campi 5 e 6 si riferisce al comando collocato sul lato effetto A e al posizionario lato effetto B; se le posizioni sono opposte, invertire i due campi 5 e 6 come da esempio seguente:

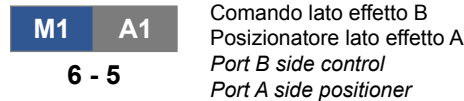
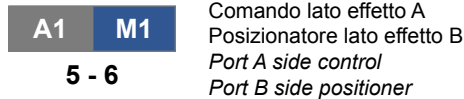

## 6 - Positioner type

\* The position of fields 5 and 6 refers to the control located on the A port side and to the positioner on the B port side. If the positions are opposite, invert the two fields 5 and 6 as shown in the example below:

## Posizionatori / Positioner

		Q35	Q15	Q25	Q45	Q65	Q75	Q95
<b>M1</b>	Tre posizioni ritorno a molla in pos.0	•	•	•	•	•	•	•
<b>M2</b>	Due posizioni 0-1 ritorno a molla in pos.0			•	•	•	•	•
<b>M3</b>	Due posizioni 0-2 ritorno a molla in pos.0			•	•	•	•	•
<b>M4(1-2)</b>	Due posizioni estreme ritorno a molla in pos.1	•		•	•	•	•	•
<b>M4(2-1)</b>	Due posizioni estreme ritorno a molla in pos.2	•		•	•	•	•	•
<b>R1</b>	Tre posizioni ritorno a molla in pos.0, detent in pos.1	•		•	•	•	•	•
<b>R2</b>	Tre posizioni ritorno a molla in pos.0, detent in pos.2	•		•	•	•	•	•
<b>R3</b>	Tre posizioni in detent	•		•	•	•	•	•
<b>R4</b>	Due posizioni in detent 0-1			•	•	•	•	•
<b>R5</b>	Due posizioni in detent 0-2			•	•	•	•	•
<b>R6</b>	Due posizioni in detent 1-2			•	•	•	•	•
<b>R8*</b>	Due posizioni (1 e 2) con ritorno a molla in pos. 0; (3) 4ª posizione flottante con detent. (Da montare con Z1 lato comando e cursore 116)		•	•	•		•	•
<b>R10/Z1*</b>	Due posizioni (1 e 2) con ritorno a molla in pos. 0, (3) 4ª posizione flottante con detent (da montare con cursore 126)			•	•		•	•
<b>R1K*</b>	Comando a 3 posizioni, detent in pos. 1 con sgancio automatico registrabile. Disponibile solo con cursore cod. 103 e 111			•	•		•	•
<b>R2K*</b>	Comando a 3 posizioni, detent in pos. 2 con sgancio automatico registrabile. Disponibile solo con cursore cod. 103 e 111			•	•		•	•
<b>R3K*</b>	Comando a 3 posizioni, detent in pos. 1 e 2 con sgancio automatico registrabile. Disponibile solo con cursore cod. 103 e 111			•	•		•	•
<b>M1-B1</b>	Tre posizioni ritorno a molla in pos.0 con comando microswitch posteriore			•	•		•	•
<b>M2-B1</b>	Due posizioni, 0-1, ritorno a molla in pos.0 con comando microswitch posteriore			•	•		•	•
<b>M3-B1</b>	Due posizioni, 0-2, ritorno a molla in pos. 0 con comando microswitch posteriore			•	•		•	•
<b>M1-N1</b> <b>M1-N1A</b> <b>M1-N1B</b>	Tre posizioni ritorno a molla in pos. 0, con attivazione del contatto elettrico del microswitch centralizzato <b>M1-N1</b> : Per doppio effetto <b>M1-N1A</b> : Per semplice effetto in pos 1 <b>M1-N1B</b> : Per semplice effetto in pos 2			•	•		•	•
<b>M2-N1</b>	Due posizioni, 0-1, con ritorno a molla in pos.0, con attivazione del contatto elettrico del microswitch centralizzato			•	•		•	•
<b>M3-N1</b>	Due posizioni, 0-2, con ritorno a molla in pos.0, con attivazione del contatto elettrico del microswitch centralizzato			•	•		•	•

## \* Limitazioni / Limitations

Posizionario Positioner	Applicabile con: / Applicable with:	
	Comando / Control	Cursore / Spool
<b>R8</b>	A1/Z1 - A2/Z1 - A4/Z1 - A6/Z1 - A8/Z1	116
<b>R10/Z1</b>	Tutti / All	126
<b>R1K</b> <b>R2K</b> <b>R3K</b>	A1 / A2 / A4 / A5 / A6 / A8 / SL / SLA15 / A15 / A16 / N1-A1 / N1-A2 / N1-A3	103 / 111

Sezione di lavoro

Working section

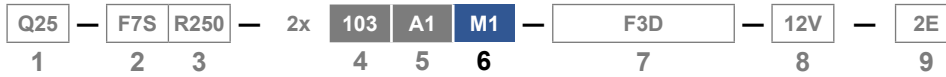

M1

Tre posizioni ritorno a molla in pos.0  
Three positions spring centred in 0



M2

Due posizioni 0-1 ritorno a molla in pos.0  
Two positions spring 0-1 centred in 0

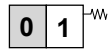

M3

Due posizioni 0-2 ritorno a molla in pos.0  
Two positions spring 0-2 centred in 0



M4 (1-2)

Due posizioni estreme ritorno a molla in pos.1  
Two end positions spring back in 1

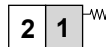

M4 (2-1)

Due posizioni estreme ritorno a molla in pos.2  
Two end positions spring back in 2

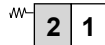

	A			
	M1	M2	M3	M4 2-1
Q15	22.5 (0.886)			
Q35	42	42	42	42
Q25 - Q45	(1.654)	(1.654)	(1.654)	(1.654)
Q65	55	55	55	55
Q75 - Q95	(2.165)	(2.165)	(2.165)	(2.165)

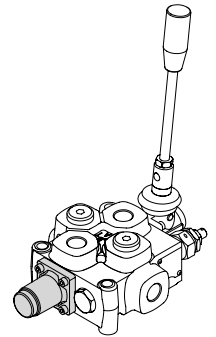

R1

Tre posizioni ritorno a molla in pos.0,  
detent in pos.1  
Three positions spring centred in 0,  
detent in 1



R2

Tre posizioni ritorno a molla in pos.0,  
detent in pos.2  
Three positions spring centred in 0,  
detent in 2



	A	
	R1	R2
Q35	52	54
Q25 - Q45	(2.047)	(2.126)
Q65	70	68.5
Q75 - Q95	(2.756)	(2.697)

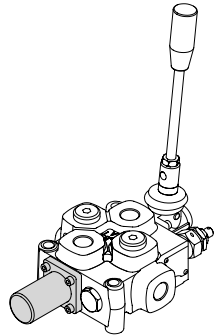

R3

Tre posizioni in detent  
Three positions detent

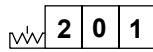

R4

Due posizioni in detent 0-1  
Two positions detent 0-1



R5

Due posizioni in detent 0-2  
Two positions detent 0-2

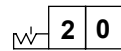

R6

Due posizioni in detent 1-2  
Two positions detent 1-2



	A			
	R3	R4	R5	R6
Q35	42	42	42	42
Q25 - Q45	(1.654)	(1.654)	(1.654)	(1.654)
Q65	55	55	55	55
Q75 - Q95	(2.165)	(2.165)	(2.165)	(2.165)

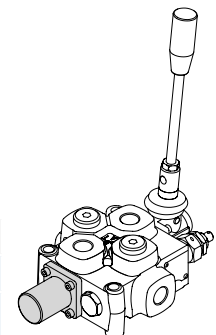



Sezione di lavoro

Working section

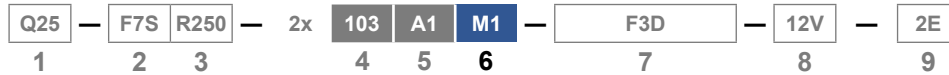

R8

Due posizioni (1 e 2) con ritorno a molla in pos. 0;  
 (3) 4ª posizione flottante con detent.  
 (Da montare con Z1 lato comando e cursore 116)  
*Two positions (1 and 2) with spring return centred in 0 position.  
 (3) 4th position floating with detent.  
 (Mounting with Z1 side control and spool 116)*

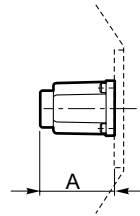

	A
Q15	43 (1.693)
Q25 - Q45	56.5 (2.224)
Q65	75
Q75 - Q95	(2.953)

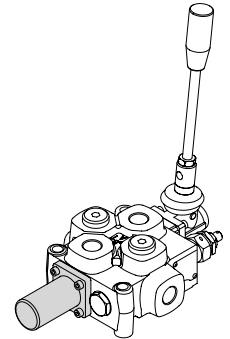

R10/Z1

Due posizioni (1 e 2) con ritorno a molla in pos. 0,  
 (3) 4ª posizione flottante con detent  
 (Da montare cursore 126)  
*Two positions (1 and 2) with spring return centred in 0 position  
 (3) 4th position floating with detent.  
 (Mounting with spool 126)*

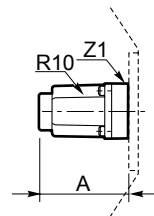
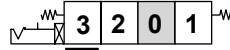

	A
Q25 - Q45	70 (2.756)
Q75 - Q95	92 (3.622)

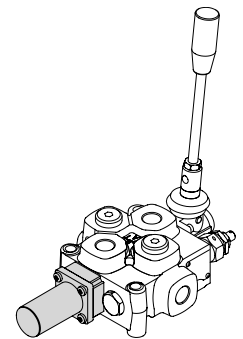

R1K

Comando a 3 posizioni, detent in pos. 1  
 con sgancio automatico registrabile.  
 Disponibile solo con cursore cod. 103 e 111  
*3 Position control, detent in 1 pos.  
 with automatic adjustable release.  
 Available with spool code 103 and 111 only*

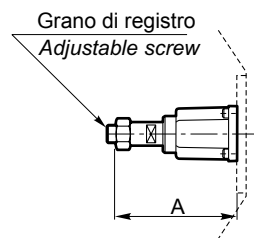
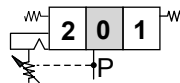

R2K

Comando a 3 posizioni, detent in pos. 2  
 con sgancio automatico registrabile.  
 Disponibile solo con cursore cod. 103 e 111  
*3 Position control, detent in 2 pos.  
 with automatic adjustable release.  
 Available with spool code 103 and 111 only*

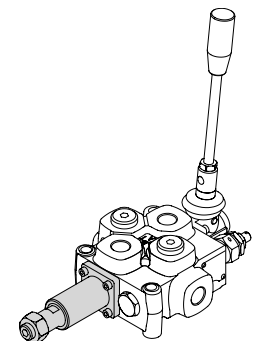
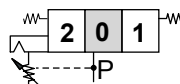

R3K

Comando a 3 posizioni, detent in pos. 1 e 2  
 con sgancio automatico registrabile.  
 Disponibile solo con cursore cod. 103 e 111  
*3 Position control, detent in 1 and 2 pos.  
 with automatic adjustable release.  
 Available with spool code 103 and 111 only*

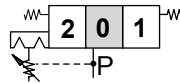

	A		
	R1K	R2K	R3K
Q25 - Q45	91.5 (3.602)	91.5 (3.602)	91.5 (3.602)
Q75 - Q95	106 (4.173)	106 (4.173)	106 (4.173)

**30.5.14 - RR NOTE FROM FULVIO GENTILE @ GALTECH  
 R1/2/3K KIT CANNOT BE RETRO FITTED TO A  
 STANDARD 103/111 SPOOL AS IT NEEDS A DEDICATED  
 SPOOL  
 TYPICAL PRESSURE ADJUSTMENT RANGE IS 45-350  
 BAR**

Sezione di lavoro

Working section

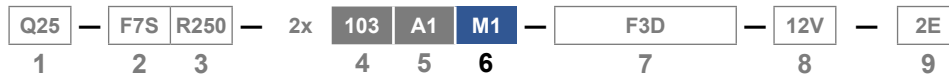

**M1-B1**

Tre posizioni ritorno a molla in pos.0 con comando microswitch posteriore  
*Three positions spring centred in 0 with back microswitch control*

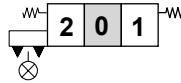

Microswitch non di nostra fornitura

*Microswitch not supplied by Galtech*

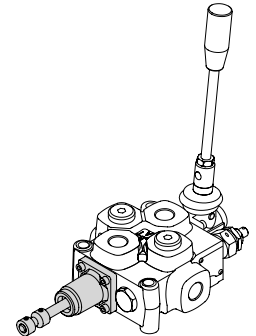
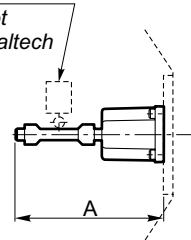

**M2-B1**

Due posizioni, 0-1, ritorno a molla in pos.0 con comando microswitch posteriore  
*Two positions, 0-1, spring centred in 0 with back microswitch control*

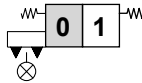

	A		
	M1-B1	M2-B1	M3-B1
<b>Q25 - Q45</b>	82 (3.228)	82 (3.228)	82 (3.228)
<b>Q75 - Q95</b>	102 (4.016)	102 (4.016)	102 (4.016)

**M3-B1**

Due posizioni, 0-2, ritorno a molla in pos. 0 con comando microswitch posteriore  
*Two positions, 0-2, spring centred in 0 with back microswitch control*

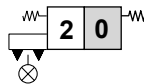

**M1-N1  
M1-N1A  
M1-N1B**

Tre posizioni ritorno a molla in pos. 0, con attivazione del contatto elettrico del microswitch centralizzato  
 M1-N1: Per doppio effetto  
 M1-N1A: Per semplice effetto in pos 1  
 M1-N1B: Per semplice effetto in pos 2  
*Three positions spring centred in 0, with ON-OFF centralized microswitch operation.*  
 N1-A1: Double acting  
 N1A-A1: Single acting in 1 position  
 N1B-A1: Single acting in 2 position

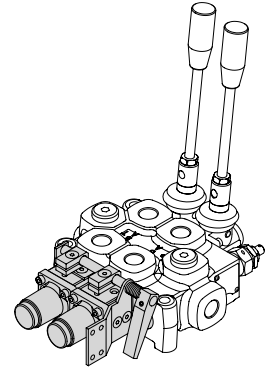
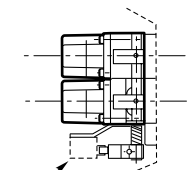
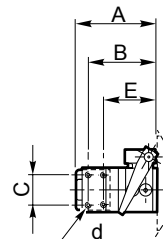
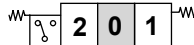

Microswitch non di nostra fornitura  
*Microswitch not supplied by Galtech*

**M2-N1**

Due posizioni, 0-1, con ritorno a molla in pos.0, con attivazione del contatto elettrico del microswitch centralizzato  
*Two positions, 0-1, with spring centred in 0, with ON-OFF centralized microswitch operation*

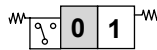

**M3-N1**

Due posizioni, 0-2, con ritorno a molla in pos.0, con attivazione del contatto elettrico del microswitch centralizzato  
*Two positions, 0-2, with spring centred in 0, with ON-OFF centralized microswitch operation*



	A	B	C	E	d
<b>Q25 - Q45</b>	70 (2.756)	59	25 (0.984)	49 (1.929)	M4
<b>Q75 - Q95</b>	84 (3.307)	59	25 (0.984)	49 (1.929)	

## Sezione di lavoro

## Working section

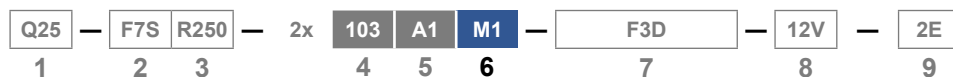

## Comandi con posizionamento / Controls with positioning

		Q35	Q25	Q45	Q75	Q95
<b>M1-U1*</b>	Tre posizioni con ritorno a molla in pos.0, attacco diretto sul cursore per rinvio a distanza rigido		•	•	•	•
<b>M2-U1*</b>	Due posizioni, 0-1, con ritorno a molla in pos.0, attacco diretto sul cursore per rinvio a distanza rigido		•	•	•	•
<b>M3-U1*</b>	Due posizioni, 0-2, con ritorno a molla in pos. 0, attacco diretto sul cursore per rinvio a distanza rigido		•	•	•	•
<b>M1-U2*</b>	Tre posizioni con ritorno a molla in pos. 0, attacco diretto sul cursore per rinvio a distanza con cavo flessibile		•	•	•	•
<b>M2-U2*</b>	Due posizioni, 0-1, ritorno a molla in pos. 0, attacco diretto sul cursore per rinvio a distanza con cavo flessibile		•	•	•	•
<b>M3-U2*</b>	Due posizioni, 0-2, ritorno a molla in pos. 0, attacco diretto sul cursore per rinvio a distanza con cavo flessibile		•	•	•	•
<b>D2*</b>	Comando elettroidraulico doppio con ritorno in pos. 0				•	•
<b>P1-N*</b>	Comando pneumatico		•	•	•	•
<b>P1-NP*</b>	Comando pneumatico progressivo		•	•	•	•
<b>D3*</b>	Comando elettropneumatico		•	•	•	•

## \* Limitazioni / Limitations

Posizionatore <i>Positioner</i>	Applicabile con: / <i>Applicable with:</i>	
	Comando / <i>Control</i>	Cursore / <i>Spool</i>
<b>M1-U1</b> <b>M2-U1</b> <b>M3-U1</b> <b>M1-U2</b> <b>M2-U2</b> <b>M3-U2</b> <b>D2</b> <b>P1-N</b> <b>P1-NP</b> <b>D3</b>	A1 / A2 / A3 / A4 / A6 / A8	Tutti tranne 116 e 126 <i>All except 116 and 126</i>

Sezione di lavoro

Working section

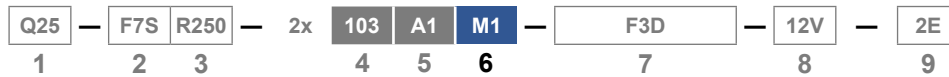

M1-U1

Tre posizioni con ritorno a molla in pos.0, attacco diretto sul cursore per rinvio a distanza rigido  
*Three positions spring centred in 0, with direct control connection on spool, cap side, for stiff remote control*



M2-U1

Due posizioni, 0-1, con ritorno a molla in pos.0, attacco diretto sul cursore per rinvio a distanza rigido  
*Two positions, 0-1, spring centred in 0, with direct control connection on spool, cap side, for stiff remote control*

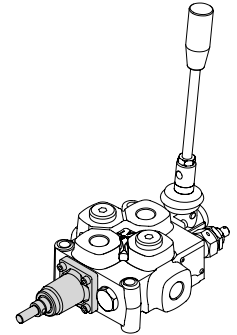
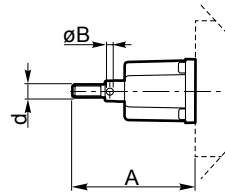
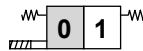

M3-U1

Due posizioni, 0-2, con ritorno a molla in pos. 0, attacco diretto sul cursore per rinvio a distanza rigido  
*Two positions, 0-2, spring centred in 0, with direct control connection on spool, cap side, for stiff remote control*

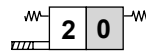

	A	B	d
Q25 - Q45	73 (2.874)	4 (0.157)	M8
Q75 - Q95	96 (3.780)	5 (0.197)	M10

M1-U2

Tre posizioni con ritorno a molla in pos. 0, attacco diretto sul cursore per rinvio a distanza con cavo flessibile  
*Three positions spring centred in 0, direct control connection on spool, cap side, for flexible remote control*



M2-U2

Due posizioni, 0-1, ritorno a molla in pos. 0, attacco diretto sul cursore per rinvio a distanza con cavo flessibile  
*Two positions, 0-1, spring centred in 0, direct control connection on spool, cap side, for flexible remote control*

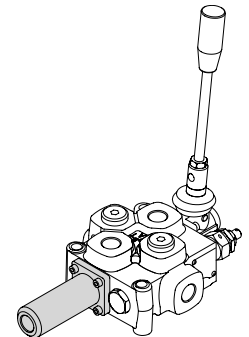
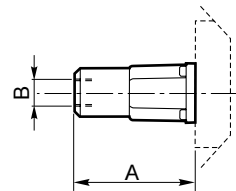
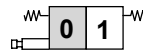

M3-U2

Due posizioni, 0-2, ritorno a molla in pos. 0, attacco diretto sul cursore per rinvio a distanza con cavo flessibile  
*Two positions, 0-2, spring centred in 0, direct control connection on spool, cap side, for flexible remote control*



	A	B
Q25 - Q45	73 (2.874)	M16X1.5
Q75 - Q95	77 (3.031)	

Sezione di lavoro

Working section

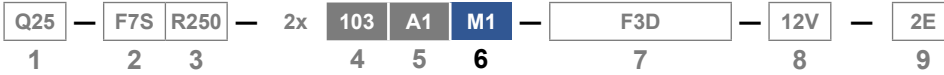

D2

Solo per Q75 e Q95  
Only for Q75 and Q95

Comando elettroidraulico doppio  
con ritorno in pos. 0  
Double electro-hydraulic  
control spring centred in 0

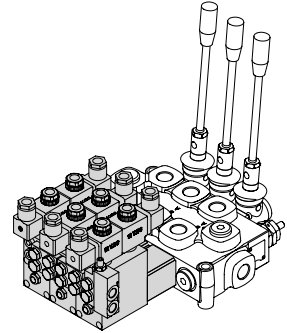
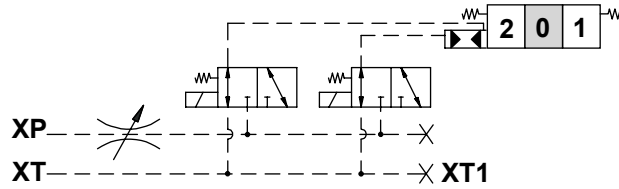

Vite di regolazione  
velocità di commutazione  
Commutation speed  
adjusting screw

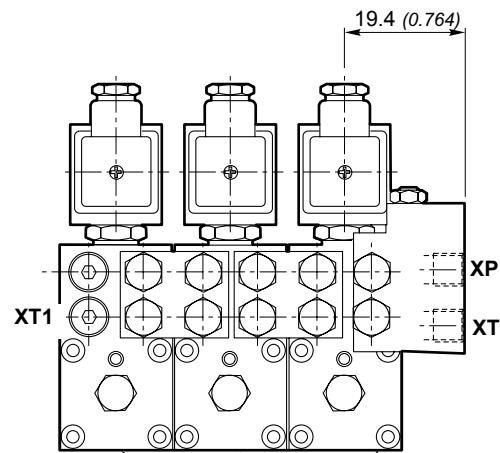
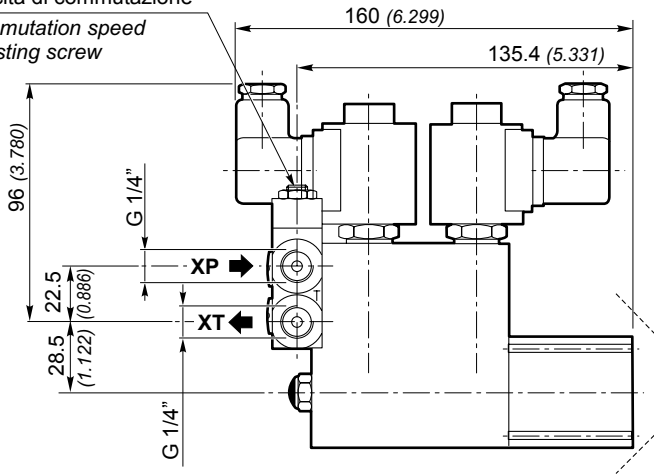

Codice: D2-2R per elementi successivi  
Code: D2-2R for the following elements

Codice: D2-1R per il 1° elemento  
Code: D2-1R for the 1° elements

Pressione di pilotaggio in XP Pilot pressure in XP		Contropressione max. su XT Maximum back pressure on XT	Portata minima per ogni elemento Minimum flow for each section	Volume di pilotaggio per elemento Piloting volume for each section
Max.	Min.	4 bar (56 PSI)	0.5 lt/min (0.132 GPM)	5.5 cm <sup>3</sup> (0.336 in <sup>3</sup> )
35 bar (490 PSI)	20 bar (280 PSI)			

Caratteristiche tecniche elettromagnete tipo "H" / Electromagnet characteristics type "H"

Attacco magnete / Magnet connection	Tipo DIN 43650 (versione A) / Type DIN 43650 (A version)
Tipo di protezione / Protection type	IP 65
Classe d'isolamento / Coil insulation class	H 180 VDE 0580
Tensione di alimentazione / Supply voltage	D.C.: 12, 24V A.C. - 50 Hz: 110, 220 V
Variazione di tensione max. / Maximum voltage tolerance	± 10%
Potenza assorbita / Absorbed power supply	18 W
Rapporto di max. utilizzo / Maximum utilization ratio	100%
Temperatura max. / Max. temperature	100° C

Sezione di lavoro

Working section

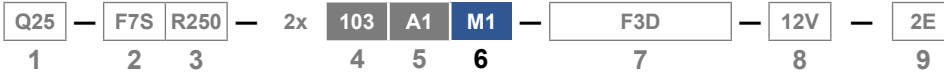

P1-N

Comando pneumatico a tre posizioni con ritorno in pos. 0  
 Three positions pneumatic control, spring centred in 0

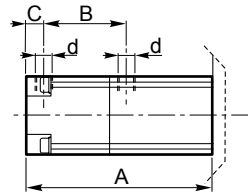
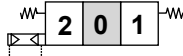

	A	B	C	d
Q25 - Q45	90.5 (3.563)	43 (1.693)	10 (0.394)	G 1/8"
Q75 - Q95	107 (4.213)	48 (1.890)	10.5 (0.413)	

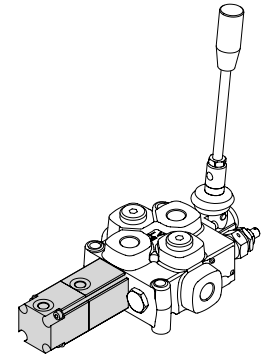

Pressione di pilotaggio / Pilot pressure	Min.	5 bar (72.5 PSI)
	Max.	30 bar (435 PSI)
Volume pilotaggio / Pilot volume	Q25-Q45	4 cm <sup>3</sup> (0.244 in <sup>3</sup> )
	Q75-Q95	9 cm <sup>3</sup> (0.549 in <sup>3</sup> )

P1-NP

Comando pneumatico progressivo a tre posizioni con ritorno in posizione 0 per azionamento con manipolatore  
 Three positions progressive pneumatic control, spring centred in 0 for remote control

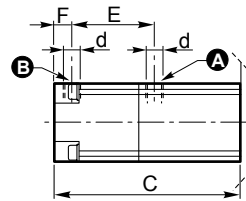

	C	E	F	d
Q25 - Q45	90.5 (3.563)	43 (1.693)	10 (0.394)	G 1/8"
Q75 - Q95	107 (4.213)	48 (1.890)	10.5 (0.413)	



Diagramma pressione di pilotaggio - Corsa spool / Pilot pressure diagram - Spool stroke



Pressione di pilotaggio / Pilot pressure	Min.	5 bar (72.5 PSI)
	Max.	30 bar (435 PSI)
Volume pilotaggio / Pilot volume	Q25-Q45	4 cm <sup>3</sup> (0.244 in <sup>3</sup> )
	Q75-Q95	9 cm <sup>3</sup> (0.549 in <sup>3</sup> )

Sezione di lavoro

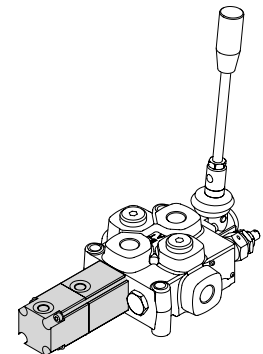
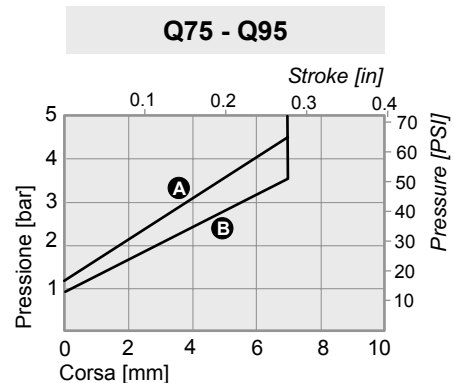
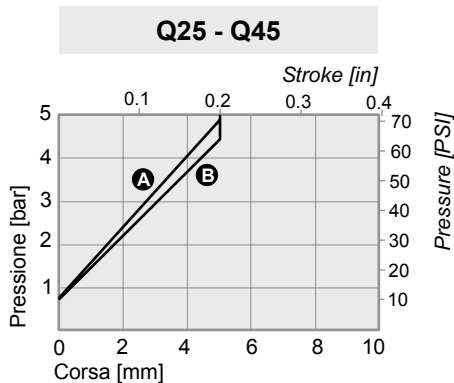
Working section

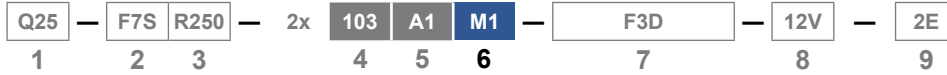

D3

Comando elettropneumatico a tre posizioni con ritorno in pos. 0  
 Three positions electro-pneumatic control, spring centred in 0

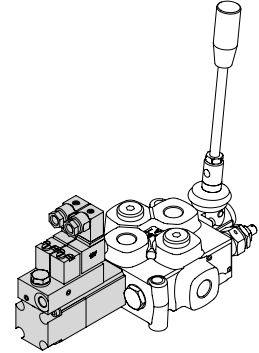
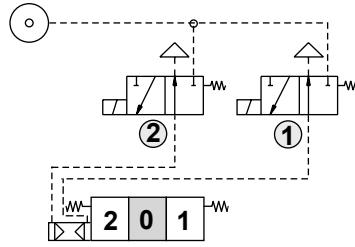

Emergenza manuale a rotazione  
 Manual override

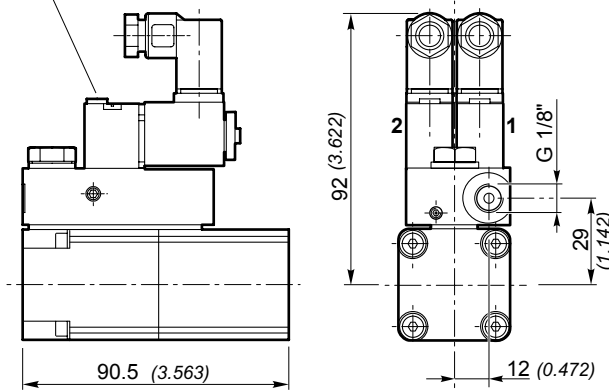

Q25 - Q45

Caratteristiche di funzionamento  
 Operation characteristics

Pressione di pilotaggio <i>Pilot pressure</i>	1 ÷ 10 bar (14.5 ÷ 145 PSI)
Volume pilotaggio <i>Pilot volume</i>	27NI/ a 6 bar Δpl (27NI/ a 87 PSI Δpl)

Caratteristiche tecniche elettromagnete  
 Electromagnet characteristics

Tipo attacco magnete <i>Magnet connection type</i>	DIN 175301-803-C
Tipo di protezione <i>Protection type</i>	IP 65
Classe d'isolamento <i>Coil insulation class</i>	F
Tensione di alimentazione <i>Supply voltage</i>	D.C.: 12, 24V A.C.: 50 Hz 230 V
Variazione di tensione max. <i>Maximum voltage tolerance</i>	± 10%
Potenza assorbita <i>Absorbed power supply</i>	D.C.: 2.9 W A.C. 4VA
Rapporto di max. utilizzo <i>Maximum utilization ratio</i>	100%
Temperatura max. <i>Max. temperature</i>	-10 ÷ 50 °C

Q75 - Q95

Caratteristiche di funzionamento  
 Operation characteristics

Pressione di pilotaggio <i>Pilot pressure</i>	1 ÷ 10 bar (14.5 ÷ 145 PSI)
Volume pilotaggio <i>Pilot volume</i>	53NI/ a 6 bar Δpl (53NI/ a 87 PSI Δpl)

Caratteristiche tecniche elettromagnete  
 Electromagnet characteristics

Tipo attacco magnete <i>Magnet connection type</i>	DIN 43650
Tipo di protezione <i>Protection type</i>	IP 65
Classe d'isolamento <i>Coil insulation class</i>	F
Tensione di alimentazione <i>Supply voltage</i>	D.C.: 12, 24V
Variazione di tensione max. <i>Maximum voltage tolerance</i>	± 10%
Potenza assorbita <i>Absorbed power supply</i>	D.C.: 5 W
Rapporto di max. utilizzo <i>Maximum utilization ratio</i>	100%
Temperatura max. <i>Max. temperature</i>	-10 ÷ 50 °C

Emergenza manuale a rotazione  
 Manual override

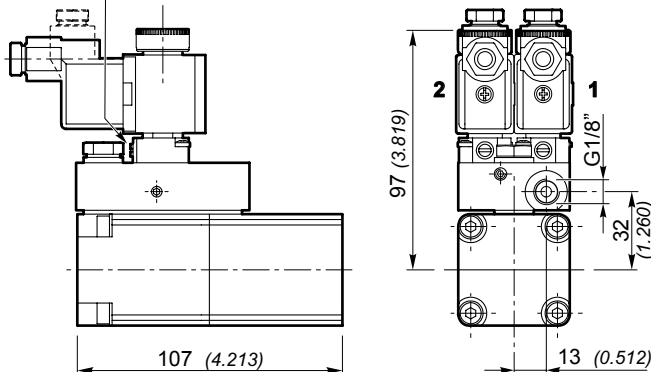

## Sezione di lavoro

## Working section

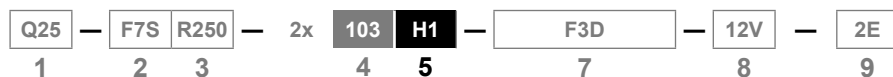

## Comandi completi / Complete controls

			Q35	Q25	Q45	Q75	Q95
H1*	Comando idraulico ad alta pressione ON-OFF a tre posizioni, ritorno a molla in posizione 0	Three positions with high-pressure hydraulic control, spring centered in 0 position		•	•	•	•
H5*	Comando idraulico a bassa pressione per manipolatore idraulico	Low pressure hydraulic control for hydraulic pilot valves		•	•	•	•
RTL-s*	Comando rotativo frizionato a tre posizioni: tacca in pos. 0, leva in pos. 2	3-position clutch-operated rotary control: notch mark in pos. 0, lever in pos. 2		•	•	•	•
RTL-d*	Comando rotativo frizionato a tre posizioni: tacca in pos. 0, leva in pos. 1	3-position clutch-operated rotary control: detent in pos. 0, lever in pos. 1		•	•	•	•
C2*	Comando a camme 2 posizioni estreme 1-2, ritorno a molla in pos. 1	Cam control, 2 end positions 1-2, spring centered in 1 position		•	•	•	•
C3*	Comando a camme 2 posizioni estreme 2-1, ritorno a molla in pos. 2	Cam control, 2 end positions 2-1, spring centered in 2 position		•	•	•	•
A1/D41*	Comando elettrico diretto doppio, ritorno a molla in pos. 0	Double direct electrical control with spring centred in 0		•	•	•	•
A2/D41*	Comando elettrico diretto doppio con leva ruotata, ritorno a molla in pos. 0	180° rotated double direct electrical control with spring centred in 0		•	•	•	•
A1/DP*	Comando elettrico diretto doppio, ritorno a molla in pos. 0	Double direct electrical control with spring centred in 0		•	•	•	•
A2/DP*	Comando elettrico diretto doppio, ritorno a molla in pos. 0	Double direct electrical control with spring centred in 0		•	•	•	•
D9*	Comando elettrico diretto a due magneti con ritorno a molla in pos. 0	Double direct electrical control with spring centred in 0		•	•	•	•

## \* Limitazioni / Limitations

Comando completo Complete control	Applicabile con: / Applicable with:
	Cursore / Spool
H1	Tutti tranne / All except 116 / 126
H5	
RTL-s	
RTL-d	
C2	
C3	101 / 102 / 103 / 107 / 108 / 109 / 110 / 111
A1/D41	
A2/D41	
A1/DP	
A2/DP	
D9	



Sezione di lavoro

Working section

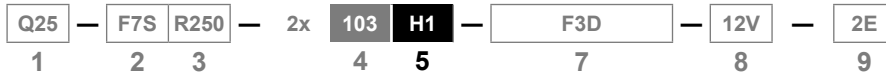

H1

Comando idraulico ad alta pressione ON-OFF a tre posizioni, ritorno a molla in posizione 0  
 Three positions whit high-pressure hydraulic control, spring centred in 0 position

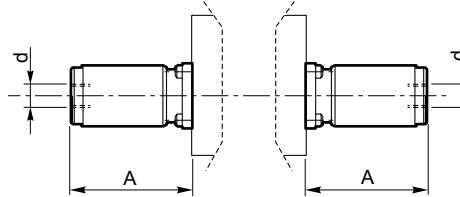
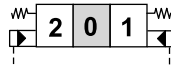

	A	d
Q25 - Q45	70 (2.756)	G 1/4
Q75 - Q95	85 (3.346)	

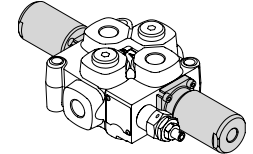

Pressione di pilotaggio / Pilot pressure	Min.	16 bar (232 PSI)
	Max.	350 bar (5075 PSI)
Volume pilotaggio / Pilot volume	Q25-Q45	2 cm <sup>3</sup> (0.122 in <sup>3</sup> )
	Q75-Q95	3 cm <sup>3</sup> (0.183 in <sup>3</sup> )

H5

Comando idraulico a bassa pressione a tre posizioni per manipolatore idraulico, ritorno a molla in posizione 0  
 Three positions whit low-pressure hydraulic control for hydraulic remote control, spring centred in 0 position

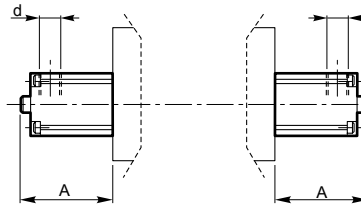
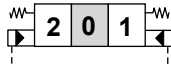

	A	d
Q25 - Q45	50 (1.969)	G 1/4
Q75 - Q95	71.5 (2.815)	



Diagramma pressione di pilotaggio - Corsa spool / Pilot pressure diagram - Spool stroke

Q25 - Q45

Q75 - Q95

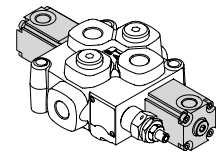
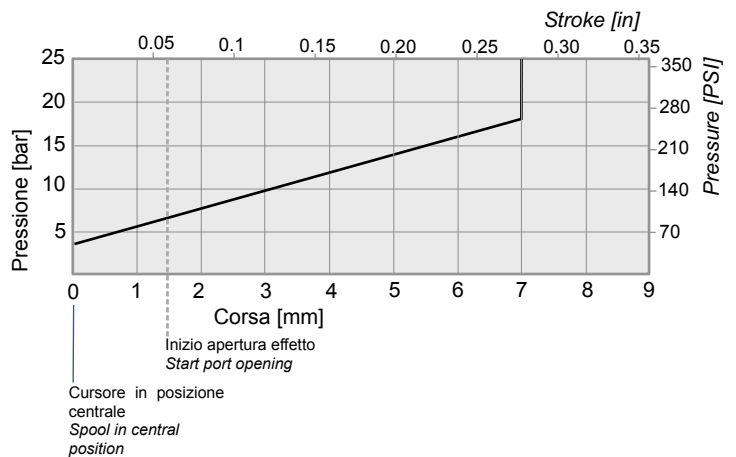
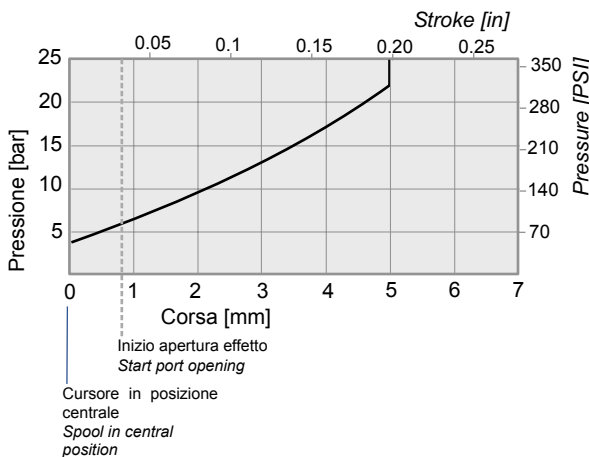

Pressione di pilotaggio / Pilot pressure	Max.	100 bar (1450 PSI)
Volume pilotaggio / Pilot volume	Q25-Q45	2 cm <sup>3</sup> (0.122 in <sup>3</sup> )
	Q75-Q95	39 cm <sup>3</sup> (2.379 in <sup>3</sup> )

N.B.  
 Le curve sono ricavate con cursore 103  
 NOTE. The curves are formed with spool 103 type

Sezione di lavoro

Working section

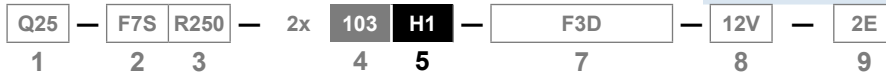

RTL-s

Tre posizioni con comando rotativo frizionato, tacca in pos. 0, leva in pos. 2  
 Three positions with rotary control, lever in 2 position

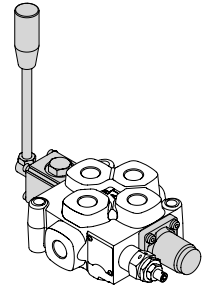
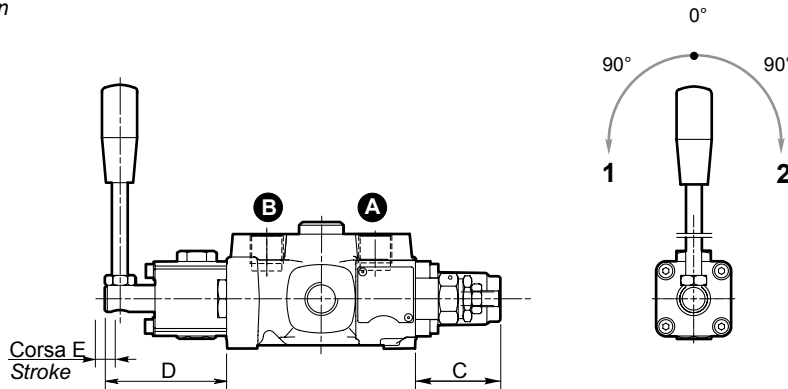
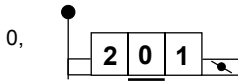

	C	D	E
Q25 - Q45	42 (1.654)	61 (2.402)	10 (5+5) 0.394 (0.197+0.197)
Q75 - Q95	55 (2.165)	72.5 (2.854)	14 (7+7) 0.551 (0.276+ 0.276)

RTL-d

Tre posizioni con comando rotativo frizionato, tacca in pos. 0, leva in pos. 1  
 Three positions with rotary control, lever in 1 position

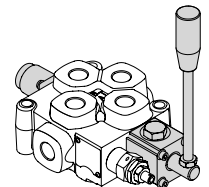
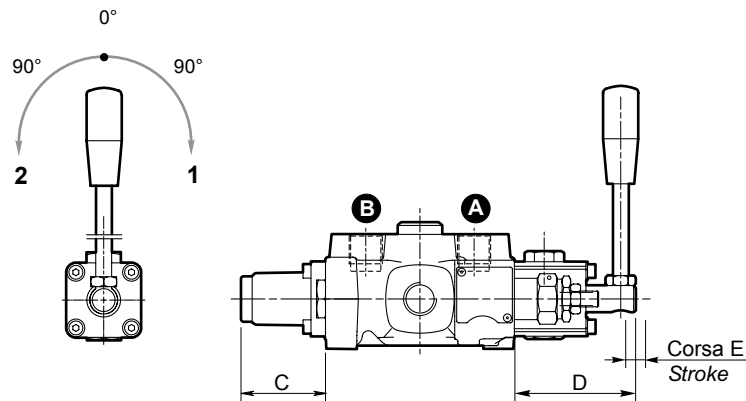
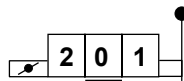

	C	D	E
Q25 - Q45	42 (1.654)	61 (2.402)	10 (5+5) 0.394 (0.197+0.197)
Q75 - Q95	55 (2.165)	72.5 (2.854)	14 (7+7) 0.551 (0.276+ 0.276)

Sezione di lavoro

Working section

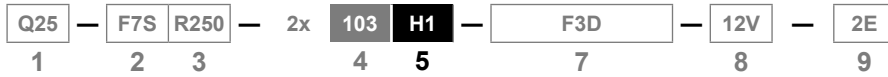

C2

Comando a camme 2 posizioni estreme 1-2, con ritorno a molla in pos. 1  
 Cam control, 2 end positions 1-2, spring centred in 1 position

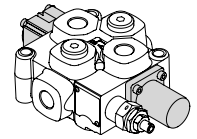
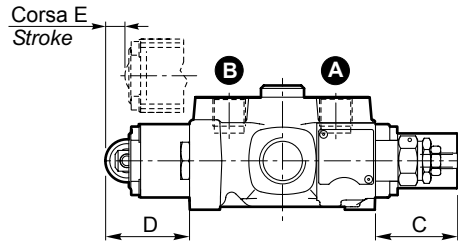
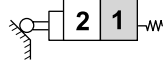

	C	D	E
Q25 - Q45	42 (1.654)	43 (1.693)	10 (0.394)
Q75 - Q95	55 (2.165)	51 (2.008)	14 (0.551)

C3

Comando a camme, 2 posizioni estreme 2-1, con ritorno a molla in pos. 2  
 Cam control, 2 end positions 2-1, spring centred in 2 position

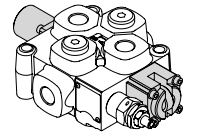
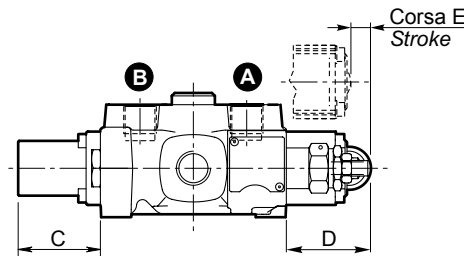
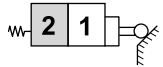

	C	D	E
Q25 - Q45	42 (1.654)	43 (1.693)	10 (0.394)
Q75 - Q95	55 (2.165)	51 (2.008)	14 (0.551)

Sezione di lavoro

Working section

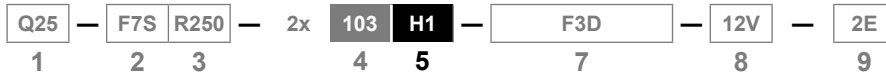

A1/D41

Comando elettrico diretto doppio ON/OFF con ritorno a molla in posizione 0  
 ON/OFF double direct electrical control with spring centred in 0

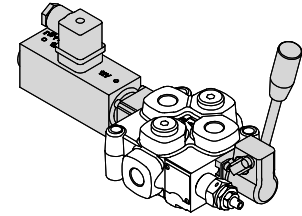
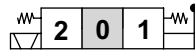

A2/D41

Comando elettrico diretto doppio ON/OFF ruotato di 180° con ritorno a molla in posizione 0  
 180° rotated ON/OFF double direct electrical control with spring centred in 0

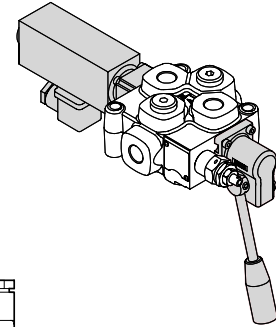
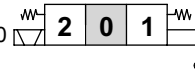

Connessione Connection		
	1 - 2	Effetto A Port A
	1 - 3	Effetto B Port B

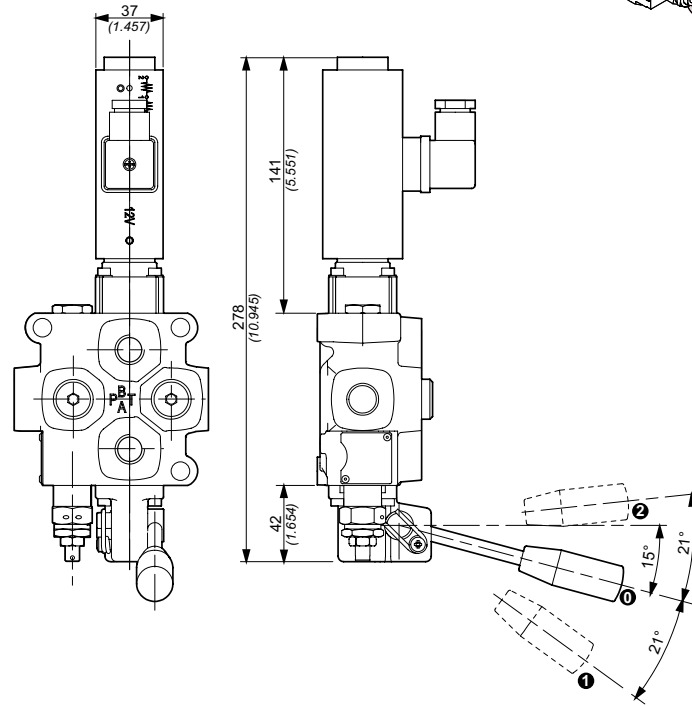

Dimensioni in / Dimensions in: mm (inch)

Caratteristiche tecniche elettromagnete / Electromagnet technical features		
Tipo distributore / Valve type	Q25	Q45
Attacco magnete / Magnet connection	Tipo/Type DIN 43650 (vers. A)	
Tipo protezione / Protection type	IP65	
Classe d'isolamento / Coil insulation class	H	
Tensione di alimentazione / Supply voltage	12V D.C./24V D.C.	
Variazione di tensione max / Maximum voltage tolerance	±10%	
Potenza assorbita / Absorbed power supply	58W	
Rapporto di massimo utilizzo / Maximum utilization ratio	100%	
Caratteristiche tecniche distributore / Directional control valve characteristics		
Portata max (lt/min) / Max. flow (Gal/min)	50 (13)	60 (16)
Pressione max di lavoro / Max. working pressure	275 bar (3988 PSI)	
Contropressione max sullo scarico / Max. back outlet pressure	25 bar (3363 PSI)	
Manovra di emergenza o in assenza di corrente / Emergency operation or in case of power failure	Con leva / With lever	
Traffilamento max di A e B in T a 100 bar con viscosità 35 mm <sup>2</sup> /s Max. spool leakage of A and B ports to T port at 1450 PSI with viscosity 35 mm <sup>2</sup> /s	5 cm <sup>3</sup> /min	

Sezione di lavoro

Working section

Limiti d'impiego / Use limits

Perdite di carico con il cursore in posizione neutra

( $\Delta p$  in funzione del numero di sezioni attraversate)

Pressure drop with spool in neutral position

( $\Delta p$  depending on the number of the crossed sections)

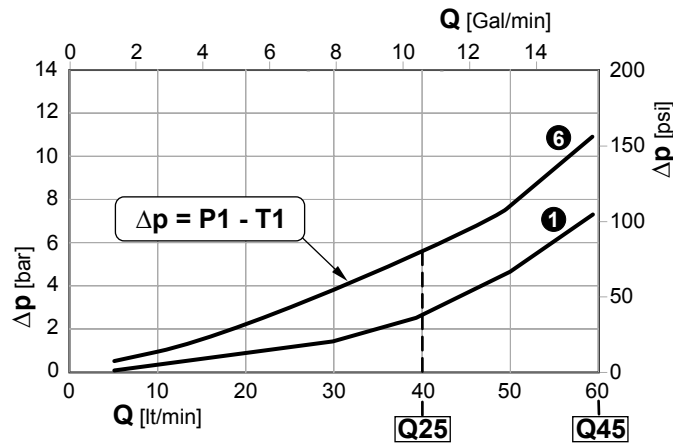
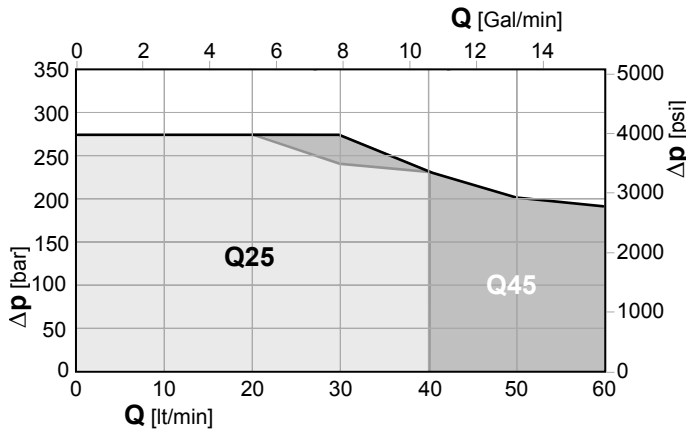
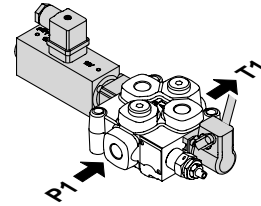

Perdite di carico con il cursore in posizione di lavoro

( $\Delta p$  in funzione del numero di sezioni attraversate)

Pressure drop with spool in working position

( $\Delta p$  depending on the number of the crossed sections)

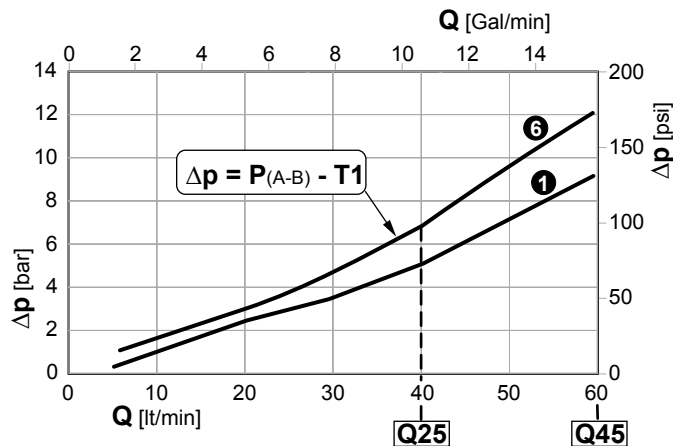
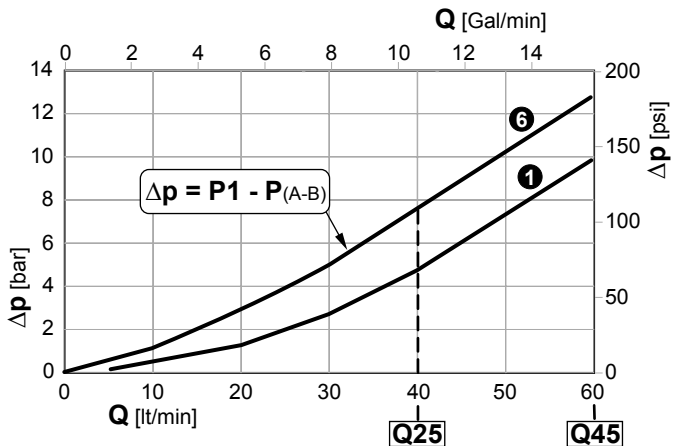
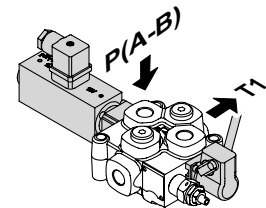
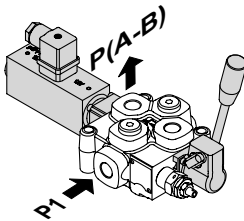

1 6 Sezioni / Sections

N.B. Le curve sono ricavate con cursore 103 / NOTE. Performance curves measured using spool 103 type.

Sezione di lavoro

Working section

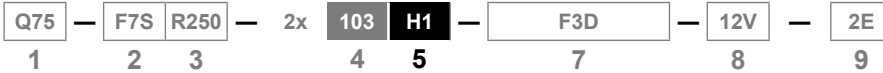

A1/D41

Comando elettrico diretto doppio ON/OFF con ritorno a molla in posizione 0  
 ON/OFF double direct electrical control with spring centred in 0

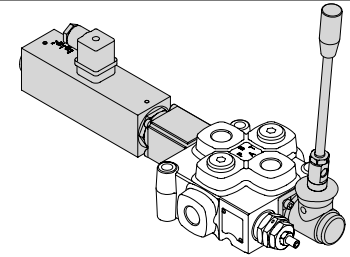
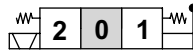

A2/D41

Comando elettrico diretto doppio ON/OFF ruotato di 180° con ritorno a molla in posizione 0  
 180° rotated ON/OFF double direct electrical control with spring centred in 0

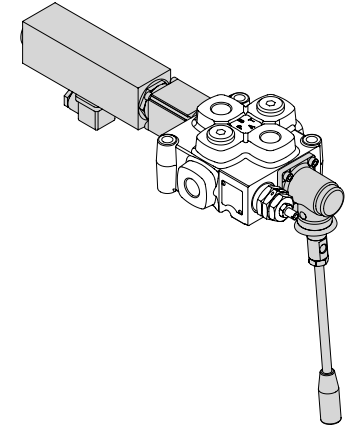
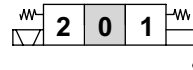

Connessione Connection		
	1 - 2	Effetto A Port A
	1 - 3	Effetto B Port B

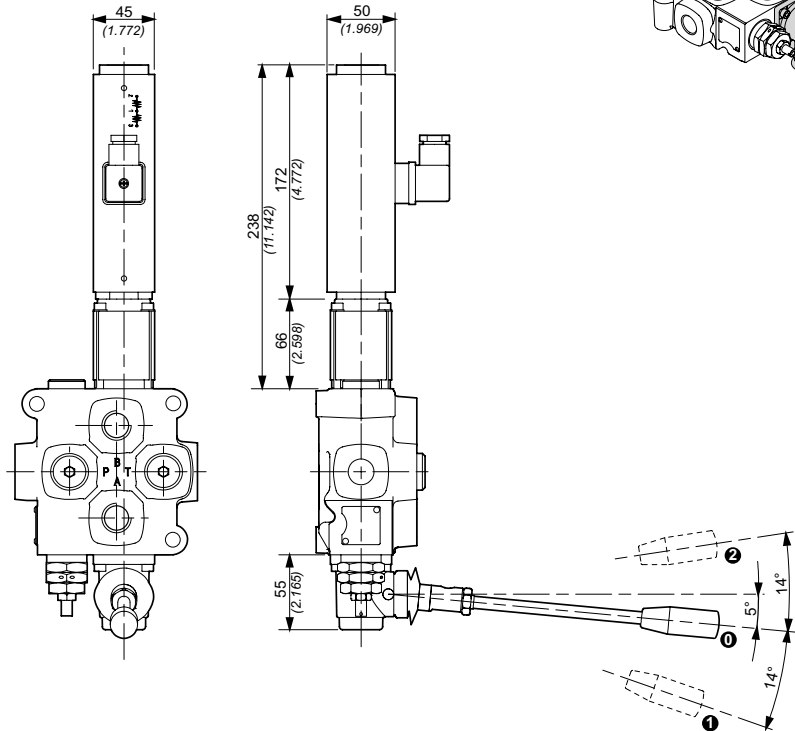

Dimensioni in / Dimensions in: mm (inch)

Caratteristiche tecniche elettromagnete / Electromagnet technical features		
Tipo distributore / Valve type	Q75	Q95
Attacco magnete / Magnet connection	Tipo/Type DIN 43650 (vers. A)	
Tipo protezione / Protection type	IP65	
Classe d'isolamento / Coil insulation class	H	
Tensione di alimentazione / Supply voltage	12V D.C./24V D.C.	
Variazione di tensione max / Maximum voltage tolerance	±10%	
Potenza assorbita / Absorbed power supply	80W	
Rapporto di massimo utilizzo / Maximum utilization ratio	100%	
Caratteristiche tecniche distributore / Directional control valve characteristics		
Portata max (lt/min) / Max. flow (Gal/min)	90 (24)	120 (32)
Pressione max di lavoro / Max. working pressure	300 bar	
Contropressione max sullo scarico / Max. back outlet pressure	25 bar	
Manovra di emergenza o in assenza di corrente / Emergency operation or in case of power failure	Con leva / With lever	
Trafilamento max di A e B in T a 100 bar con viscosità 35 mm <sup>2</sup> /s Max. spool leakage of A and B ports to T port at 1450 bar with viscosity 35 mm <sup>2</sup> /s	5 cm <sup>3</sup> /min	

Sezione di lavoro

Working section

Limiti d'impiego / Use limits

Perdite di carico con il cursore in posizione neutra

( $\Delta p$  in funzione del numero di sezioni attraversate)  
**Pressure drop with spool in neutral position**  
 ( $\Delta p$  depending on the number of the crossed sections)

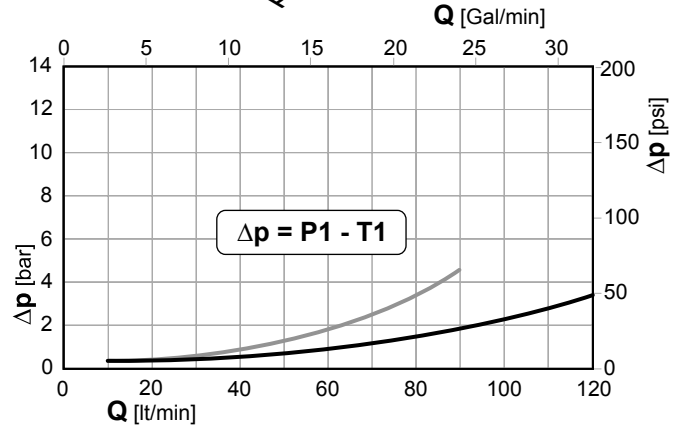
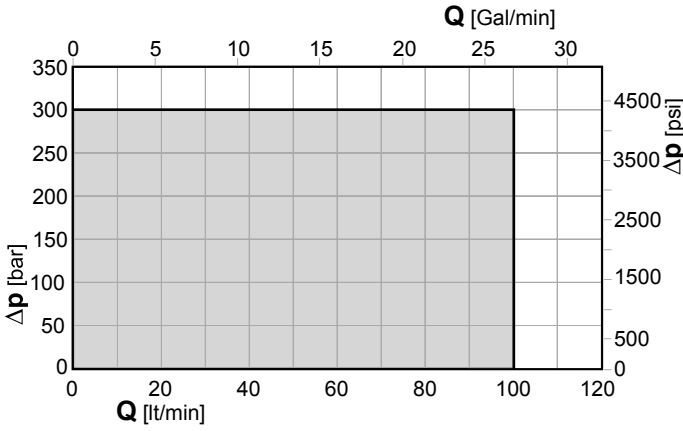
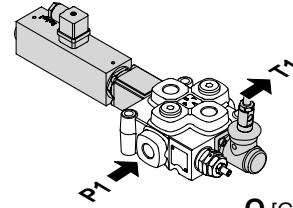

Perdite di carico con il cursore in posizione di lavoro

( $\Delta p$  in funzione del numero di sezioni attraversate)  
**Pressure drop with spool in working position**  
 ( $\Delta p$  depending on the number of the crossed sections)

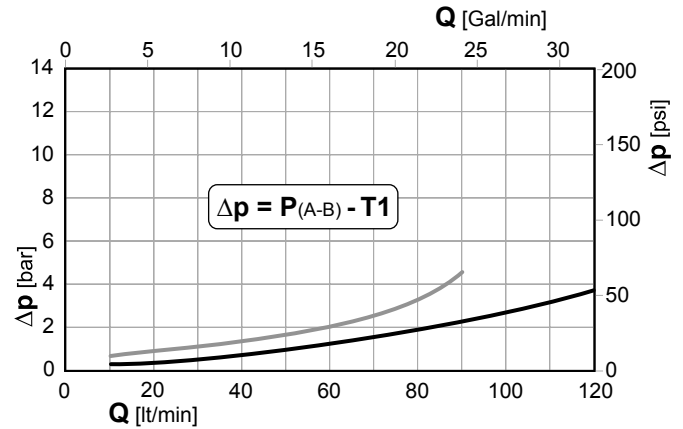
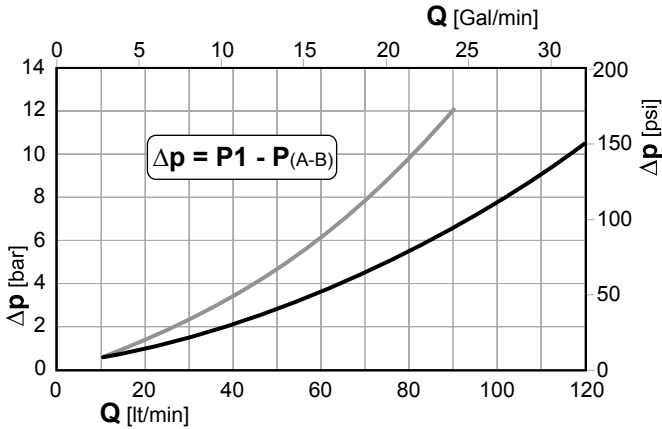
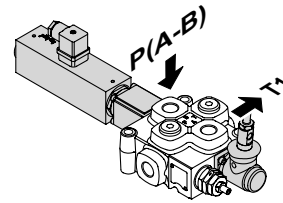
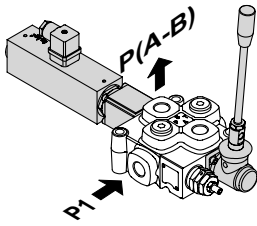

- 1 Elemento Q95 / 1 section Q95
- 1 Elemento Q75 / 1 section Q75

N.B. Le curve sono ricavate con cursore 103 / NOTE. Performance curves measured using spool 103 type.

Sezione di lavoro

Working section

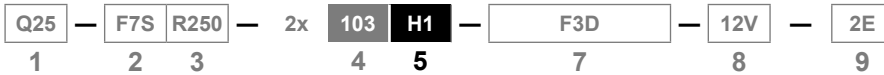

**A1/DP**

Comando elettrico diretto doppio con magnete proporzionale e ritorno a molla in posizione 0  
 Double direct electrical control with proportional solenoid and spring centred in 0

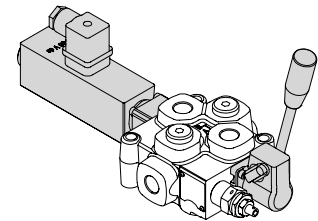

**A2/DP**

Comando elettrico diretto doppio con magnete proporzionale ruotato di 180° e ritorno a molla in posizione 0  
 180° rotated double direct electrical control with proportional solenoid and spring centred in 0

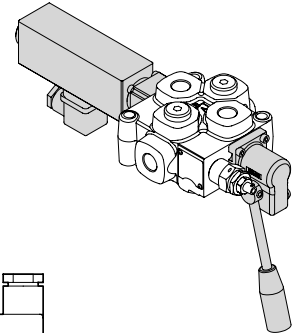
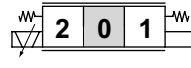

Connessione Connection		
	1 - 2	Effetto A Port A
	1 - 3	Effetto B Port B

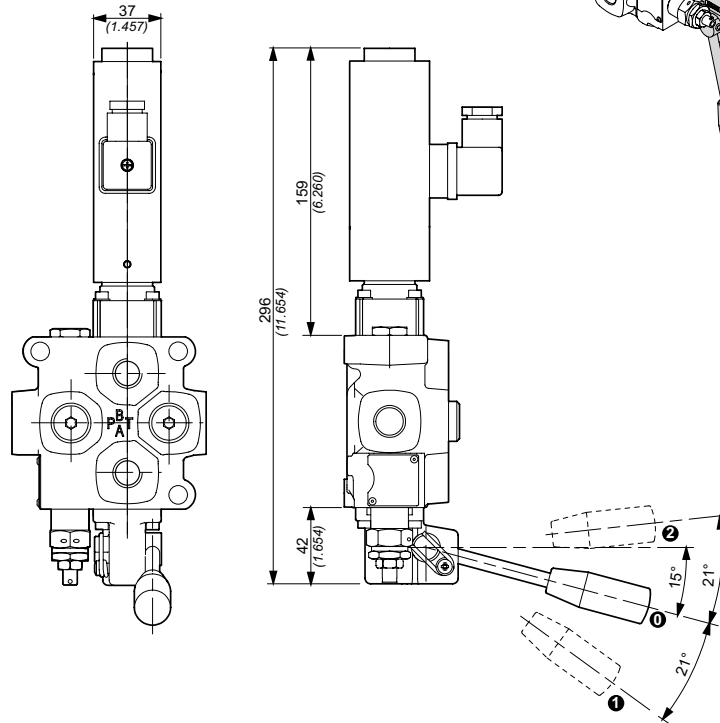

Dimensioni in / Dimensions in: mm (inch)

Caratteristiche tecniche elettromagnete / Electromagnet technical features		
Tipo distributore / Valve type	<b>Q25</b>	<b>Q45</b>
Attacco magnete / Magnet connection	Tipo/Type DIN 43650 (vers. A)	
Tipo protezione / Protection type	IP65	
Classe d'isolamento / Coil insulation class	H	
Tensione di alimentazione / Supply voltage	da 10 a 30V (con controllo di corrente) / (with current control)	
Corrente di regolazione / Current range	1 ÷ 7 A	
Rapporto d'inserzione / Related of insertion	100%	
Caratteristiche tecniche distributore / Directional control valve characteristics		
Portata max (lt/min) / Max. flow (Gal/min)	50 (13)	60 (16)
Pressione max di lavoro / Max. working pressure	275 bar	
Contropressione max sullo scarico / Max. back outlet pressure	25 bar	
Manovra di emergenza o in assenza di corrente / Emergency operation or in case of power failure	Con leva / With lever	
Trafilamento max di A e B in T a 100 bar con viscosità 35 mm <sup>2</sup> /s Max. spool leakage of A and B ports to T port at 1450 bar with viscosity 35 mm <sup>2</sup> /s	5 cm <sup>3</sup> /min	



Sezione di lavoro

Working section

Limiti d'impiego / Use limits

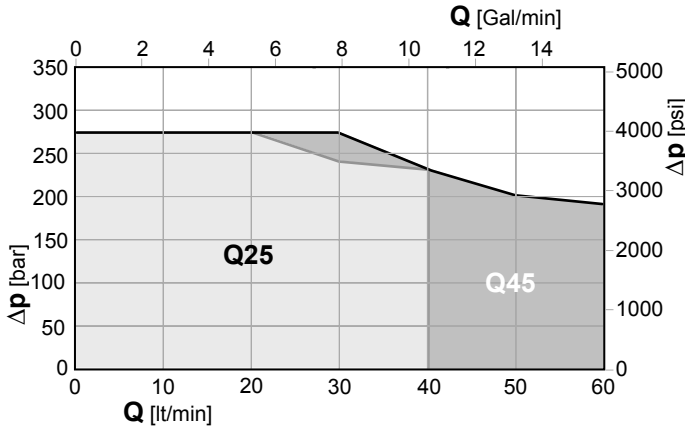

Perdite di carico con il cursore in posizione neutra

( $\Delta p$  in funzione del numero di sezioni attraversate)  
 Pressure drop with spool in neutral position  
 ( $\Delta p$  depending on the number of the crossed sections)

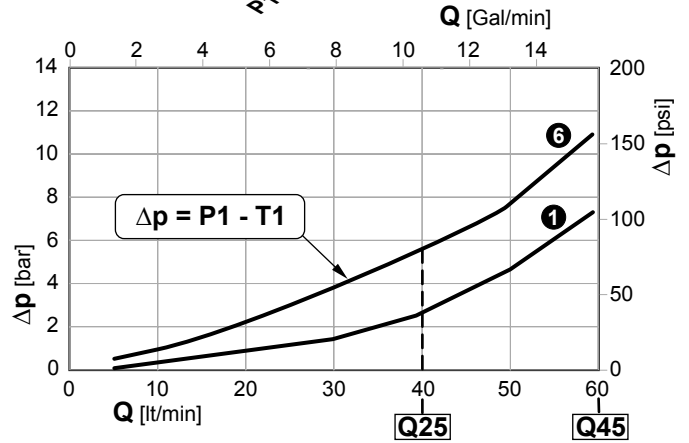
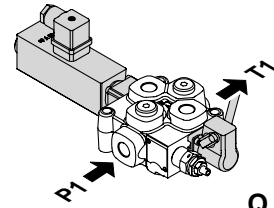

Perdite di carico con il cursore in posizione di lavoro

( $\Delta p$  in funzione del numero di sezioni attraversate)  
 Pressure drop with spool in working position  
 ( $\Delta p$  depending on the number of the crossed sections)

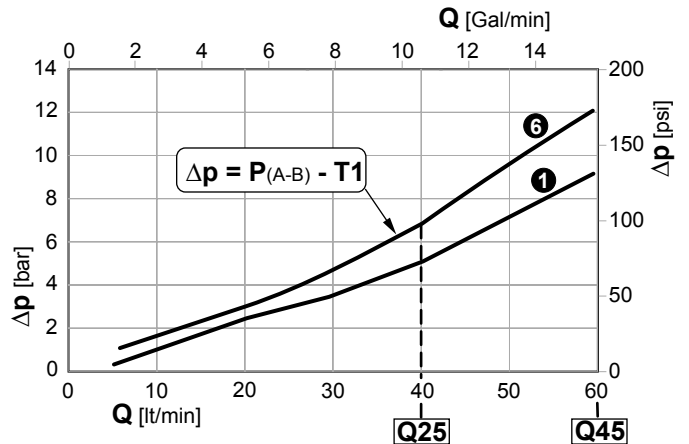
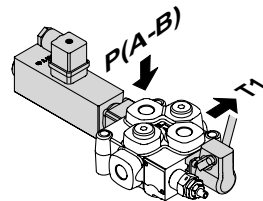
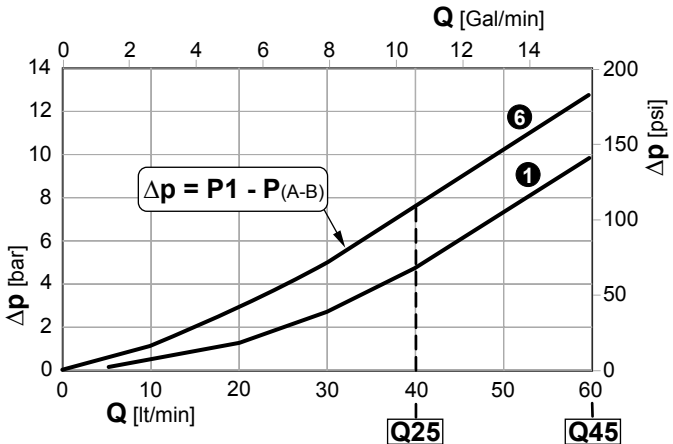
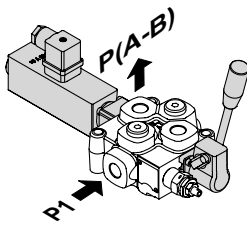

① ⑥ Sezioni / Sections

N.B. Le curve sono ricavate con cursore 103 / NOTE. Performance curves measured using spool 103 type.

## Scheda elettronica SGM-05

### Descrizione

La scheda SGM-05 è equipaggiata di n° 12 uscite pilotate in corrente con regolazione PWM. Tali uscite sono da intendersi per movimenti a due a due antagonisti, più altre tre uscite per carichi ON/OFF.

È dotata altresì di 6 ingressi proporzionali con tensione di riposo di 2.5V adatti ad essere collegati ad altrettanti joysticks tipo JOYS-100. La contemporaneità massime dei comandi proporzionali è pari a tre. Sono a disposizione 4 ulteriori ingressi logici per funzioni di discriminazione di eventi e situazioni.

### Applicazioni

La scheda SGM-05 è studiata per il controllo di distributore idraulico GALTECH dotato d'elettromagneti sia proporzionali che ON/OFF, gli ingressi sono direttamente collegabili ai joysticks della postazione remota.

Esempi:

- A. Elettrodistributore con valvole/elettromagneti direzionali ON-OFF-ON ed elettrovalvola proporzionale in mandata. Al primo azionamento di uno dei joysticks s'inserisce la relativa valvola direzionale e conseguentemente viene pilotata la valvola proporzionale. Viene consentita una sola manovra per volta.
- B. Distributore con comando elettromagnetico proporzionale delle spole. Si rendono disponibili 6+6 uscite proporzionali tramite le quali è possibile comandare anche tre movimenti proporzionali contemporaneamente.

### Funzionamento

La disponibilità d'ulteriori ingressi ON/OFF oltre ai sei proporzionali dei joysticks, danno la possibilità alla scheda di ricevere comandi, al fine di discriminare situazioni (blocco momento, appoggio stabilizzatori, ecc.) operando di conseguenza (blocco selettivo delle funzioni, riduzione velocità, ecc.).

Per le applicazioni tipo "A" è possibile avere la versione con "risparmio di corrente" sui carichi ON/OFF.

### Tarature e configurazioni

La regolazione dei valori di corrente I<sub>min</sub> ed I<sub>max</sub> per le varie manovre e la configurazione delle funzioni degli ingressi digitali avviene tramite un tastierino esterno, da collegarsi ad apposito connettore, che agevola tra l'altro la duplicazione delle impostazioni per produzioni di serie di macchine.

A richiesta viene fornito un software per PC e una piccola interfaccia per semplificare, archiviare e richiamare le tarature.

## Electronic board SGM-05

### Description

The card SGM-05 is equipped with 12 output signals with PWM mode current regulation. These outputs are designed for two by two opposing movements, and there are other three outputs for ON/OFF type load.

It also has 6 proportional inputs with 2.5V idle position voltage, suitable for connection to an equal number of joysticks of the JOYS-100 type. Maximum four proportional controls can be used at the same time. 4 more logic inputs are available for functions that discriminate events and situations.

### Applications

The SGM-05 card has been designed for controlling GALTECH proportional and ON/OFGF hydraulic directional control valves equipped with electromagnets. The inputs can be connected directly to the joysticks of the remote station.

Examples:

- A. Electro-control valve with ON-OFF-ON directional valves/electromagnets and proportional solenoid valve on the delivery side. The directional valve is activated as soon as one of the joysticks is operated and this consequently pilots the proportional valve. One single manoeuvre can be carried out at a time.
- B. Control valve with proportional electromagnetic control of the spools. 6+6 proportional outputs become available and can be used to control up to four proportional movements at the same time.

### Operation

Besides the six proportional inputs of the joysticks, further ON/OFF inputs allow the board to receive controls so as to discriminate situations (blocking of the boom, stabilizer positioning, etc.) and operate as a consequence (selective blocking of the functions, slowing speed, etc.).

The version with "current saving" on ON/OFF loads is available for "A" type applications.

### Settings and configurations

An external keypad, which must be connected to a dedicated connector, is used to regulate the I<sub>min</sub> and I<sub>max</sub> current values for the various different manoeuvres and to configure the functions of the digital inputs. Amongst other things, this also makes it easier to duplicate the settings for mass produced machines.

Software for PC and a small interface for simplifying, filing and recalling the settings can be supplied on request.

## Scheda elettronica SGM-05

## Electronic board SGM-05

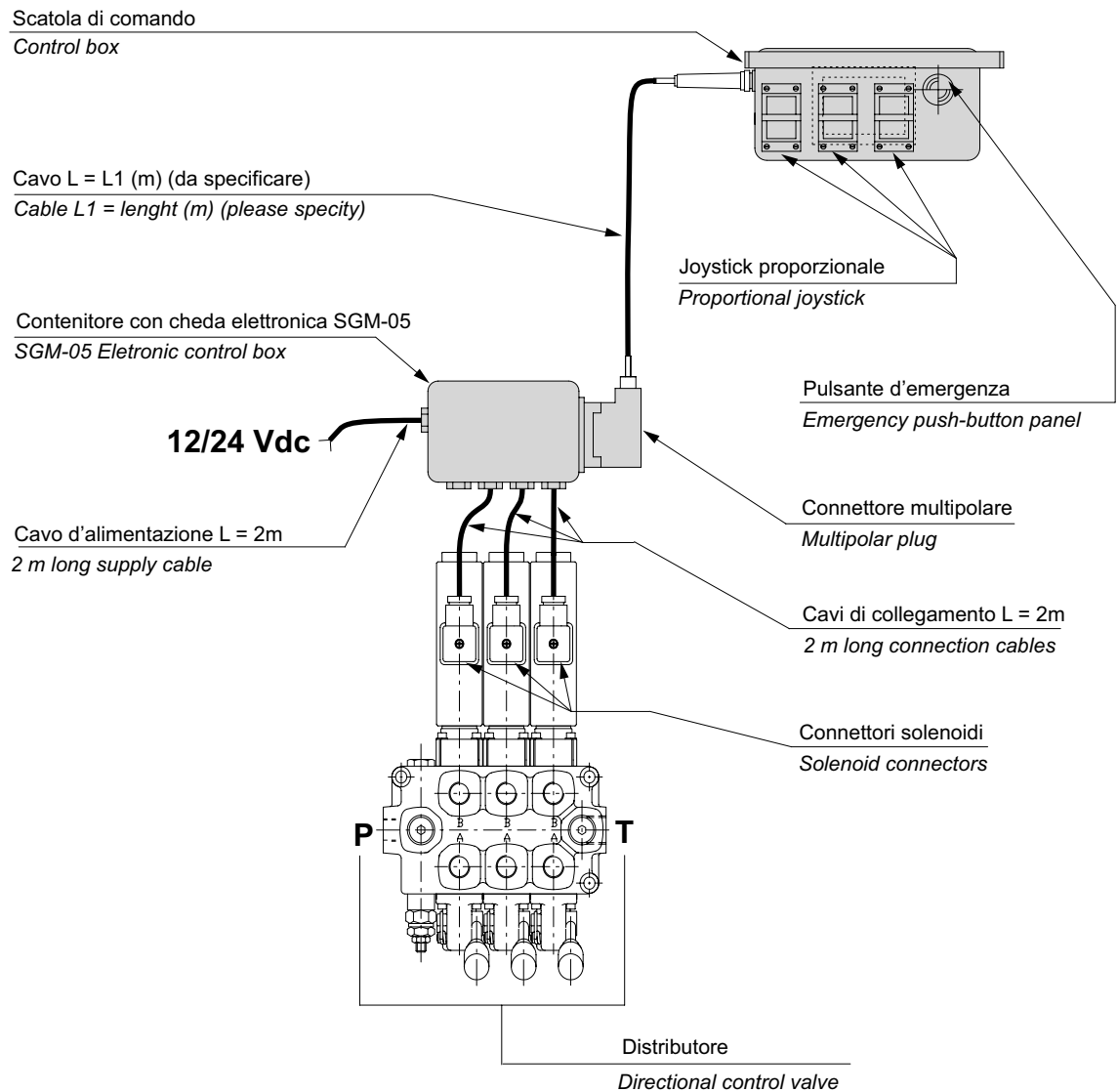

## Caratteristiche / Features

Alimentazione / Power supply	da 10V a 30V
Autoconsumo / Current consumption	50mA - 12V
N° di uscite proporzionali / Number of proportional outputs	6x2
N° di uscite on/off / Number of on/off outputs	3
Corrente di regolazione per elettromagneti proporzionali / Current regulation for proportional electromagnets	da 0.1A a 7.0A
Corrente massima sui carichi on/off / Maximum current on on/off loads	5A
N° di ingressi proporzionali / Number of proportional inputs	6
N° di ingressi digitali (on/off) / Number of digital inputs(on/off)	4
Segnalazioni a led per ingressi ed uscite / Led indications for inputs and outputs	a bordo / on board
Campo di temperatura / Temperature range	-25°C ÷ 85°C
Terminazioni / Terminations	connessioni per faston 6.3 mm fast-on connections (0.248 inch)
Dimensioni massime / Maximum dimensions	165x120 (6.496x4.724)
Uscite protette dal cortocircuito / Outputs protected against short-circuits	
Protezione con resina poliuretanic / Coated with polyurethane resin	
Versioni di funzionamento diverse su richiesta / Different operating versions available on request	

## Joystick monoasse senza contatto JOYS-100

## JOYS-100 single-axis contactless joystick

### Caratteristiche

Fornisce una tensione proporzionale allo spostamento della leva dalla posizione di riposo.

- ingombro ridotto
- insensibile agli agenti atmosferici
- semplicità d'installazione

### Features

Supplies a voltage proportional to lever shift from its idle position.

- small size
- unaffected by environment agents
- simple to install

Alimentazione / Power supply	5 Vcc
Angolo d'azione / Angular range	da -28° a +28° riposo centrale / central idle position
Impedenza d'uscita / Output impedance	1K
Tensione segnale d'uscita / Output signal voltage	0.5V ÷ 4.5V
Corrente max su Ud1 e Ud2 / Max current on Ud1 and Ud2	0.1 A
Temperatura di funzionamento / Operating temperature	-10°C+70°C
Contenitore / Housing	Meccanica in NYLON66 + elettronica inglobata in resina Mechanical parts in NYLON66 + resin coated electronics
Grado di protezione / Protection degree	IP67
Collegamenti / Connections	Strip passo 2.54 mm con ritenuta meccanica 1 inch pitch strip with mechanical detent
Tipo dima installazione / Type of installation template	Da pannello / Panel mounting

### Funzionamento

A componente alimentato (5 V) ed in posizione di riposo, si ha una tensione d'uscita su Up (rispetto al terminale GND) pari a  $2.5V \pm 0.2V$ .

Anche su Ud si ha una tensione di  $0.5V \pm 0.2V$ . Spostando la leva dalla posizione di riposo si ha su Up una variazione di tensione che è proporzionale allo spostamento in ragione di 71mV per grado angolare.

L'uscita Ud1, che risulta scollegata a riposo, passa a 4.5V  $\pm$  0.2V dopo 2° angolari di spostamento in una direzione.

Analogamente Ud2, anch'essa scollegata a riposo, passa a 4.5V  $\pm$  0.2V dopo 2° angolari di spostamento nella direzione opposta. Quando Ud1 è a 4.5V, Ud2 è scollegata e viceversa.

Il sistema di comando ad alimentazione unica (12Vcc ÷ 24Vcc) esercita la sua azione proporzionale sulle singole spole del distributore tramite elettromagneti doppi, a loro volta alimentati in PWM mediante la scheda elettronica a microprocessore SGM-05, dove i segnali di comando sono inviati da joystick proporzionali.

Questi joystick possono essere forniti singolarmente oppure cablati in modo standard con le seguenti composizioni:

Pulsantiera in materiale plastico con installati i joystick a tenuta stagna, uno per ogni sezione del distributore, un pulsante d'emergenza a fungo, cavo antischiacciamento e connettore multipolare.

Scatola di derivazione, con alloggiata la scheda elettronica SGM-05, per alimentare in PWM fino a 6 elettromagneti doppi proporzionali, tre uscite ON/OFF per azionamenti generici e una per la valvola di sicurezza.

Oltre ai 6 ingressi dei joystick, altri 4 ingressi ON/OFF permettono combinazioni funzionali (blocco di alcune manovre, riduzione di velocità, allarmi, ..., ecc.) da definirsi al momento dell'ordine.

### Functioning

There is a  $2.5 V \pm 0.2 V$  output voltage on Up (in relation to the GND terminal) when the component is powered (5 V) and in the idle position.

There is also  $0.5 V \pm 0.2 V$  voltage on Ud. When the lever is shifted from the idle position, the voltage variation on Up is proportional to the movement to the extent of 71 mV per angular degree.

Output Ud1, when unswitched and on idle position, switches to  $4.5 V \pm 0.2 V$  after a 2° angular movement in one direction.

Similarly, Ud2, when unswitched and on idle position, switches to  $4.5 V \pm 0.2 V$  after a 2° angular movement in the opposite direction. When Ud is at 4.5 V, Ud2 will be disconnected, and vice-versa.

The control system with single power supply (12 Vdc to 24 Vdc) allows proportional action on the individual spools of the control valve thanks to double electromagnets. These are powered in PWM mode by electronic microprocessor board SGM-05, where the control signals are transmitted by proportional joysticks.

These joysticks can be supplied either individually or wired in the standard way with the following compositions:

Push button panel made of plastic material fitted with watertight joysticks, one for each section of the control valve, a emergency button, crush-proof cable and multicore connector.

Switch box contains the SGM-05 electronic card for powering, in PWM, up to 6 double proportional electromagnets, three ON/OFF outputs for generic drives and one for the safety bypass valve.

Besides the joysticks 6 inputs, more 4 ON/OFF inputs allow functional combinations to be obtained (blocking of certain manoeuvres, slowing, alarms, ..., etc.). These combinations must be defined at the time of order.

**Joystick monoasse senza contatto JOYS-100**

**JOYS-100 single-axis contactless joystick**

La scheda SGM-05 consente un massimo di quattro manovre contemporanee e la regolazione/memorizzazione dei parametri per ogni movimento (velocità minima, velocità massima, rampe

*The SGM-05 card allows up to four manoeuvres to be made at the same time and adjustment/memorizing of the parameters for each movement (minimum speed, maximum speed, acceleration ramps...*) can be achieved through the supply of:

d'accelerazione...) può avvenire tramite fornitura di:

*A - a user-friendly portable keyboard.*

A - un tastierino portatile di semplice utilizzo.

*B - an intuitive programming software installed in a personal computer.*

B - un intuitivo software di programmazione installato su personal computer.

Il sistema qui sommariamente presentato può essere modificato/adattato per soddisfare le specifiche esigenze del cliente.

*The system briefly described in this document can be modified/ adapted to suit the customer's specific requirements.*

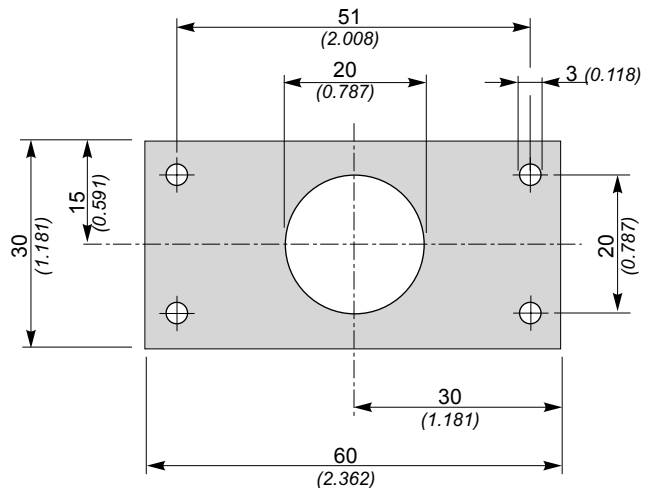
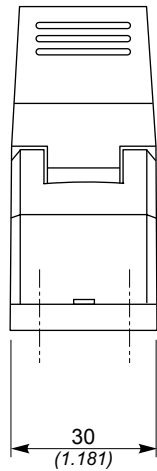
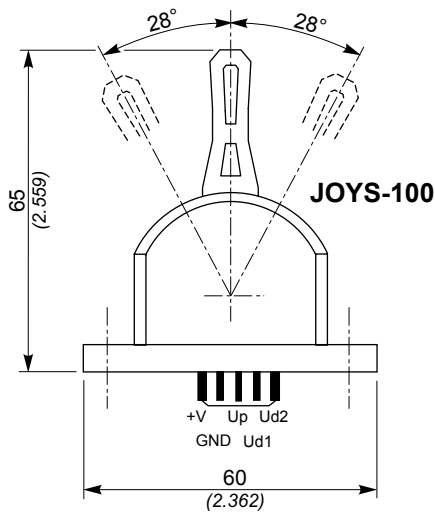
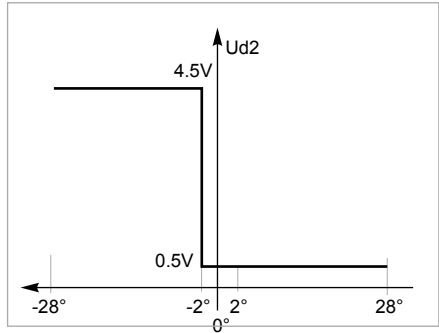
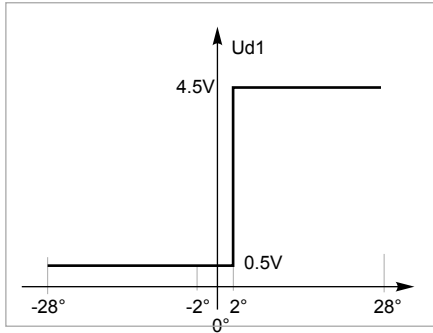
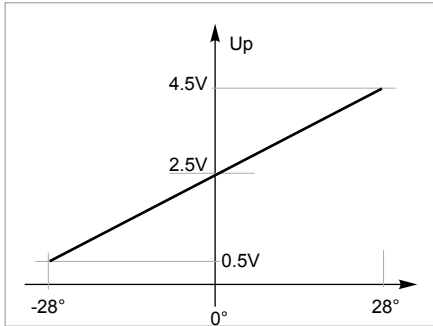

**Dima di foratura / Drilling template**

## Sezione di lavoro

## Working section



## D9

Comando elettrico diretto doppio ON/OFF  
con ritorno a molla in posizione 0  
ON/OFF double direct electrical control  
with spring centred in 0

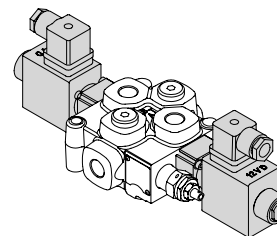
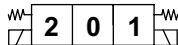

Connessione Connection		
	1 - 2	Effetto A Port A
	1 - 3	Effetto B Port B

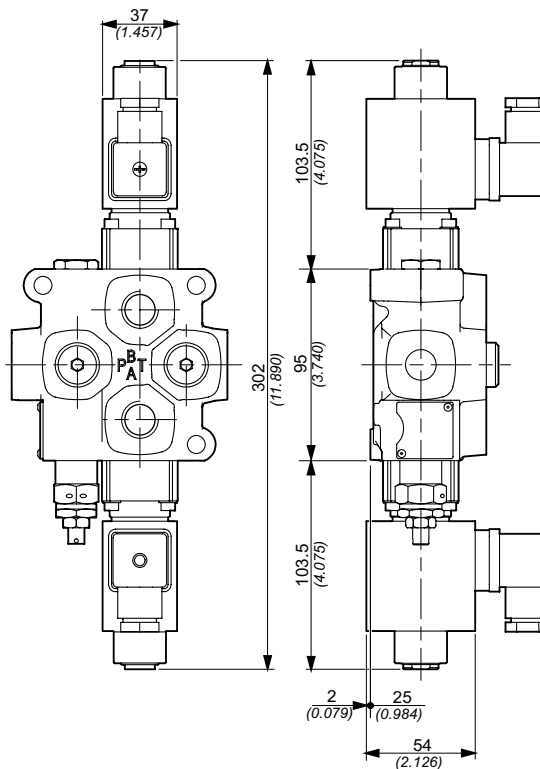

Dimensioni in / Dimensions in: mm (inch)

Caratteristiche tecniche elettromagnete / Electromagnet technical features		
Tipo distributore / Valve type	Q25	Q45
Attacco magnete / Magnet connection	Tipo/Type DIN 43650 (vers. A)	
Tipo protezione / Protection type	IP65	
Classe d'isolamento / Coil insulation class	H	
Tensione di alimentazione / Supply voltage	12V D.C./24V D.C.	
Variazione di tensione max / Maximum voltage tolerance	±10%	
Potenza assorbita / Absorbed power supply	58W	
Rapporto di massimo utilizzo / Maximum utilization ratio	100%	
Caratteristiche tecniche distributore / Directional control valve characteristics		
Portata max / Max. flow	50	60
Pressione max di lavoro / Max. working pressure	275 bar	
Contropressione max sullo scarico / Max. back outlet pressure	25 bar	
Manovra di emergenza o in assenza di corrente / Emergency operation or in case of power failure	A pulsante in spinta / Push type	
Trafilamento max di A e B in T a 100 bar con viscosità 35 mm <sup>2</sup> /s / Max. spool leakage of A and B ports to T port at 100 bar with viscosity 35 mm <sup>2</sup> /s	5 cm <sup>3</sup> /min	

Sezione di lavoro

Working section

Limiti d'impiego / Use limits

Perdite di carico con il cursore in posizione neutra

( $\Delta p$  in funzione del numero di sezioni attraversate)  
 Pressure drop with spool in neutral position  
 ( $\Delta p$  depending on the number of the crossed sections)

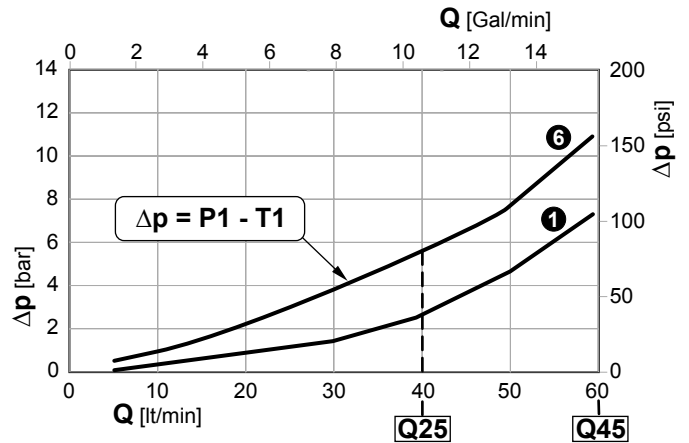
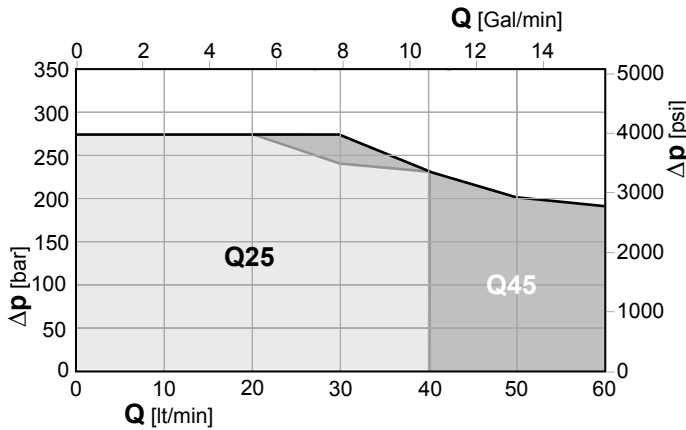
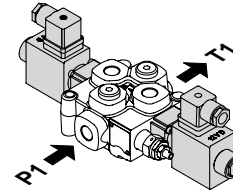

Perdite di carico con il cursore in posizione di lavoro

( $\Delta p$  in funzione del numero di sezioni attraversate)  
 Pressure drop with spool in working position  
 ( $\Delta p$  depending on the number of the crossed sections)

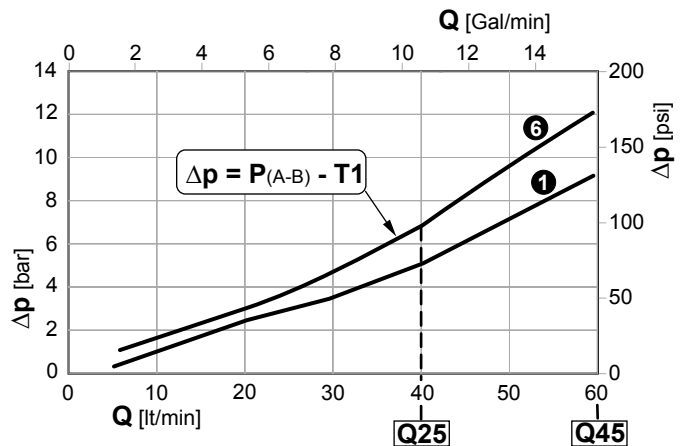
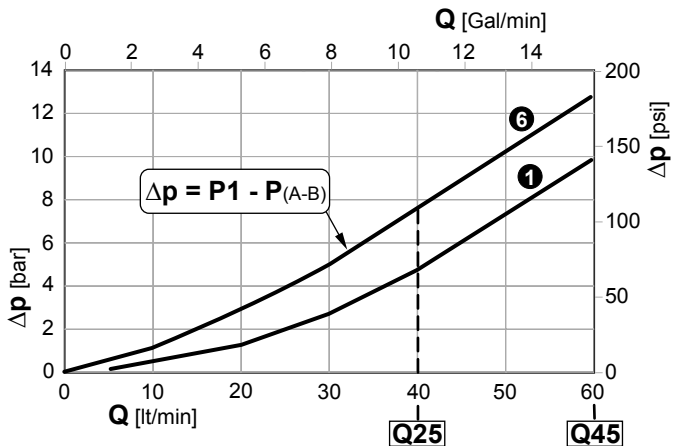
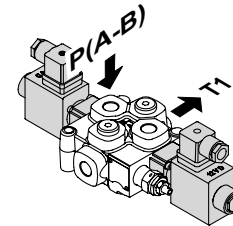
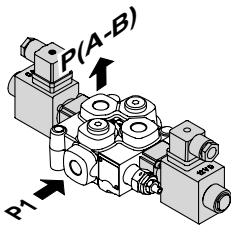

① ⑥ Sezioni / Sections

N.B. Le curve sono ricavate con cursore 103 / NOTE: Performance curves measured using spool 103 type.





**D9**

Comando elettrico diretto doppio ON/OFF con ritorno a molla in posizione 0  
 ON/OFF double direct electrical control with spring centred in 0

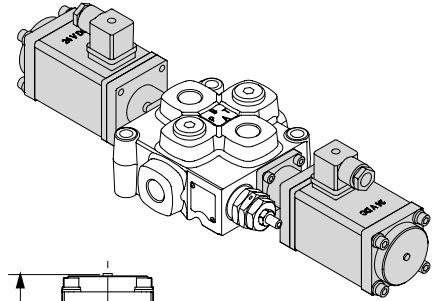
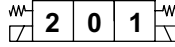

Connessione Connection		
	1 - 2	Effetto A Port A
	1 - 3	Effetto B Port B

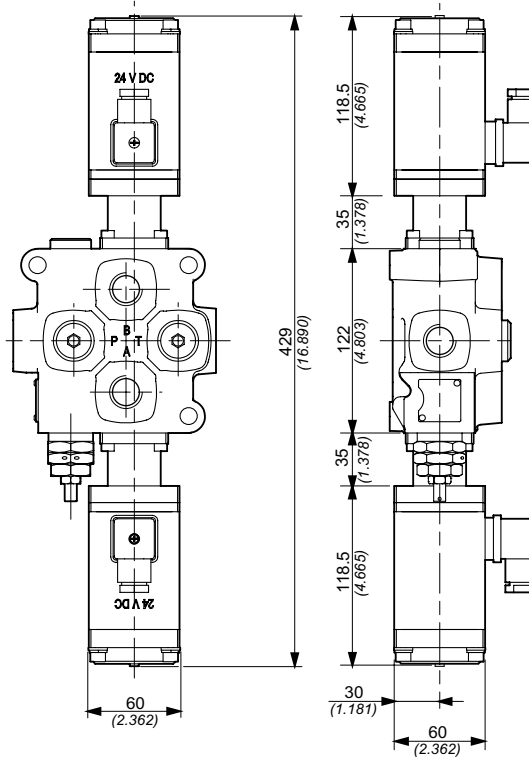

Dimensioni in / Dimensions in: mm (inch)

Caratteristiche tecniche elettromagnete / Electromagnet technical features		
Tipo distributore / Valve type	<b>Q75</b>	<b>Q95</b>
Attacco magnete / Magnet connection	Tipo/Type DIN 43650 (vers. A)	
Tipo protezione / Protection type	IP65	
Classe d'isolamento / Coil insulation class	H	
Tensione di alimentazione / Supply voltage	12V D.C./24V D.C.	
Variazione di tensione max / Maximum voltage tolerance	±10%	
Potenza assorbita / Absorbed power supply	80W	
Rapporto di massimo utilizzo / Maximum utilization ratio	100%	
Caratteristiche tecniche distributore / Directional control valve characteristics		
Portata max / Max. flow	90	120
Pressione max di lavoro / Max. working pressure	210 bar	
Contropressione max sullo scarico / Max. back outlet pressure	25 bar	
Manovra di emergenza o in assenza di corrente / Emergency operation or in case of power failure	A pulsante in spinta / Push type	
Trafilamento max di A e B in T a 100 bar con viscosità 35 mm <sup>2</sup> /s / Max. spool leakage of A and B ports to T port at 100 bar with viscosity 35 mm <sup>2</sup> /s	7 cm <sup>3</sup> /min	



Sezione di lavoro

Working section

Limiti d'impiego / Use limits

Perdite di carico con il cursore in posizione neutra

( $\Delta p$  in funzione del numero di sezioni attraversate)  
**Pressure drop with spool in neutral position**  
 ( $\Delta p$  depending on the number of the crossed sections)

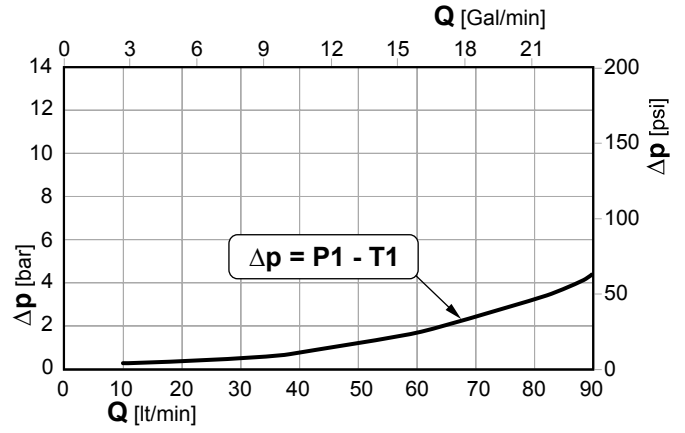
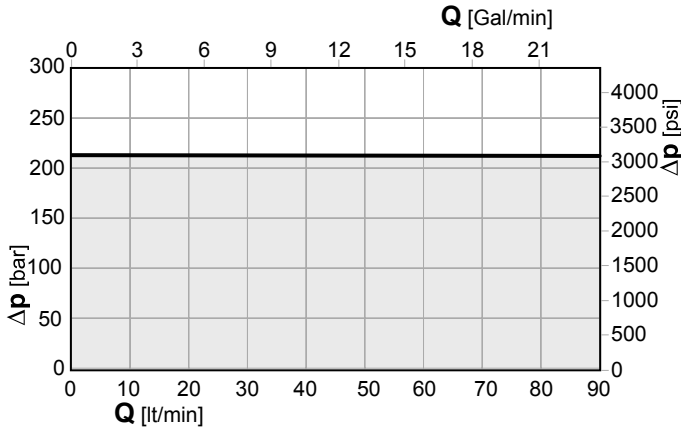
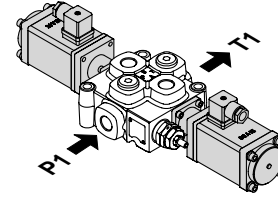

Perdite di carico con il cursore in posizione di lavoro

( $\Delta p$  in funzione del numero di sezioni attraversate)  
**Pressure drop with spool in working position**  
 ( $\Delta p$  depending on the number of the crossed sections)

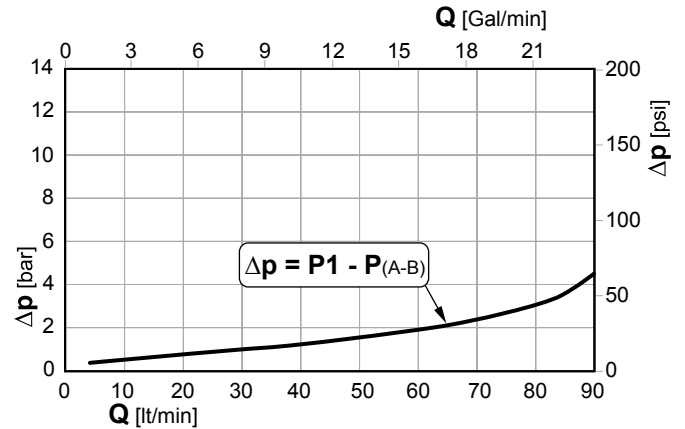
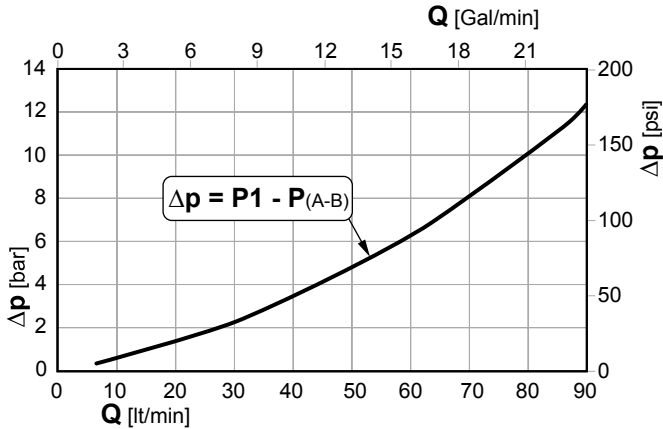
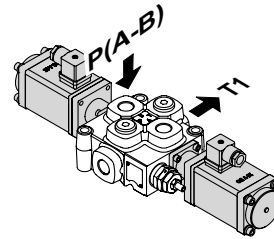
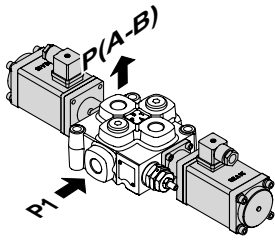

N.B. Le curve sono ricavate con cursore 103 / NOTE. Performance curves measured using spool 103 type.



**7 - Tipo fiancata di scarico / Outlet section type**

		Q15	Q35	Q25	Q45	Q65	Q75	Q95
<b>F3D</b>	Fiancata di scarico <i>Outlet section</i>	•	•	•	•	•	•	•
<b>F6D</b>	Fiancata di scarico con alimentazione in pressione per altri componenti (carry-over) <i>Outlet section and high pressure (carry-over)</i>			•	•		•	•
<b>F16D</b>	Fiancata di scarico destro per centro chiuso <i>Right outlet section for through passage closed</i>			•	•		•	•

**F3D**

Fiancata di scarico  
*Outlet section*

**F6D**

Fiancata di scarico con alimentazione in pressione per altri componenti (carry-over)  
*Outlet section and high pressure (carry-over)*

**F16D**

Fiancata di scarico destro per centro chiuso  
*Right outlet section for through passage closed*

## Note aggiuntive

## Additional notes

Q25	F7S	R250	2x	103	A1	M1	F3D	12V	2E
1	2	3		4	5	6	7	8	9

## 8 - Note aggiuntive / Additional notes

## 8 - Additional notes

12V, 24V

S Alluminio (pag. F-6 ... F-10)

12V, 24V

S Aluminium (page F-6 ... F-10)

Codice asta di comando (vedi tabella seguente)

Control lever code (see next table)

Codice / Code	Versione / Version	M	L	D	A	B	Colore / Color
---------------	--------------------	---	---	---	---	---	----------------

Q35 - Q25 - Q45		Dimensioni in / Dimensions in: mm (inch)						
06.029.22862	1	Standard / Standard	M8	164 (6.457)	20 (0.787)	57 (2.244)	20 (0.787)	Nero / Black
06.029.30335	1	Standard / Standard	M8	164 (6.457)	20 (0.787)	57 (2.244)	20 (0.787)	Rosso / Red
06.029.30528	1	Lunga tipo A / Long version type A	M8	184 (7.244)	20 (0.787)	57 (2.244)	20 (0.787)	Nero / Black
06.029.30492	1	Lunga tipo A / Long version type A	M8	184 (7.244)	20 (0.787)	57 (2.244)	20 (0.787)	Rosso / Red
06.029.28922	1	Lunga / Long version	M8	204 (8.031)	20 (0.787)	57 (2.244)	20 (0.787)	Nero / Black
06.029.30336	1	Lunga / Long version	M8	204 (8.031)	20 (0.787)	57 (2.244)	20 (0.787)	Rosso / Red
06.029.27421	1	Extra lunga / Extra-long	M8	324 (12.756)	20 (0.787)	57 (2.244)	20 (0.787)	Nero / Black
06.029.22876	1	Extra corta / Extra-short	M8	82 (3.228)	18 (0.709)	50 (1.969)	20 (0.787)	Nero / Black
06.029.29451	2	Standard con oblo' / Standard with lens	M8	174 (6.850)	32 (1.260)	46 (1.811)	20 (0.787)	Nero / Black
06.029.29423	2	Lunga con oblo' / Long with lens	M8	214 (8.425)	32 (1.260)	46 (1.811)	20 (0.787)	Nero / Black

Q75 - Q95		Dimensioni in / Dimensions in: mm (inch)						
06.029.27013	1	Standard / Standard	M10	209 (8.228)	20 (0.787)	57 (2.244)	28 (1.102)	Nero / Black
06.029.28148	1	Lunga / Long version	M10	357 (14.055)	20 (0.787)	57 (2.244)	28 (1.102)	Nero / Black
06.029.27344	1	Corta / Short version	M10	154 (6.063)	20 (0.787)	57 (2.244)	28 (1.102)	Nero / Black
06.029.27635	1	Extra corta / Extra-short	M10	66 (2.598)	26 (1.024)	42 (1.654)	22 (0.866)	Nero / Black
06.029.29866	2	Standard con oblo' / Standard with lens	M10	219 (8.622)	32 (1.260)	46 (1.811)	28 (1.102)	Nero / Black
06.029.30295	2	Lunga con oblo' / Long with lens	M10	367 (14.449)	32 (1.260)	46 (1.811)	28 (1.102)	Nero / Black

Per comando elettrico / For electric control Q25 - Q45		Dimensioni in / Dimensions in: mm (inch)						
06.029.28945	1	Standard / Standard	Ø7	133 (5.236)	20 (0.787)	57 (2.244)	15 (0.591)	Nero / Black
06.029.29349	1	Lunga / Long version	Ø7	201 (7.913)	20 (0.787)	57 (2.244)	15 (0.591)	Nero / Black
06.029.30951	2	Standard con oblo' / Standard with lens	Ø7	143 (5.630)	32 (1.260)	46 (1.811)	15 (0.591)	Nero / Black

Dimensioni in / Dimensions in: mm (inch)

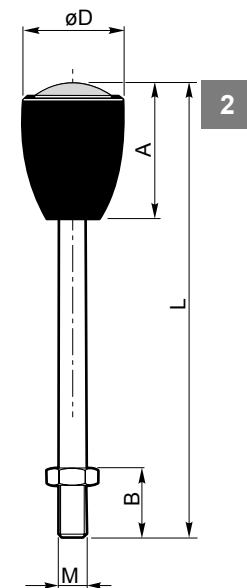
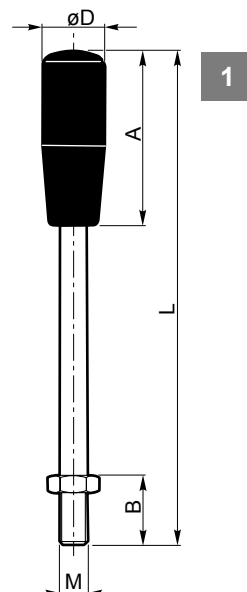

## Note aggiuntive

## Additional notes

Q25	F7S	R250	2x	103	A1	M1	F3D	12V	2E
1	2	3		4	5	6	7	8	9

## 9 - Numero elementi

## 9 - Number of sections

Specificare il numero delle sezioni di lavoro previste (es. 2E).

Specify the number of working sections used (e.g. 2E).

## ESEMPI DI ORDINAZIONE IN CODICE ORDERING CODE EXAMPLES

Q25 - F1S R(250) - 103/A1/M1 - 103/A1/D41 - 103/A1/DP - F3D - 12V - 3E

A	B		C			D	E	
1	2	3	4 - 5 - 6			7	8 - 9	
Q25	F1S	R250	103/A1/M1			F3D	12V - 3E	
			103/A1/D41					
			103/A1/DP					

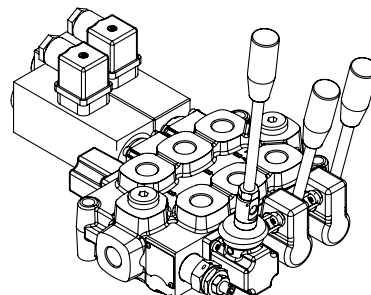

Schema idraulico  
Hydraulic symbol

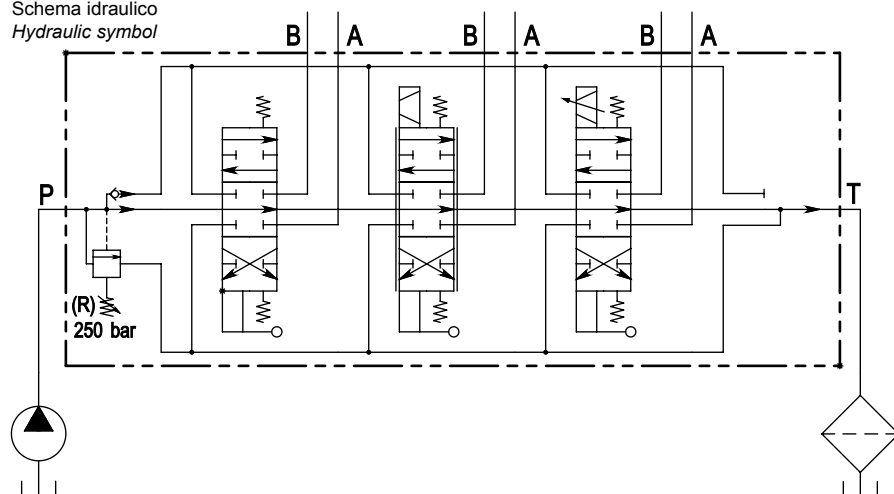

Q25 - F1S(N) - 103/M1/A15-S - 103/M1/V30(N) - 2x103/M1/A1 - 103/M1/A15-D/V30(N) - 103/M1/V32(N) - F3D - 6E

A	B		C			D	E	
1	2	3	4 - 5 - 6			7	8 - 9	
Q25	F1S	N190	103/M1/A15-S			F3D	6E	
			103/M1/V30(N)					
			2x 103/M1/A1					
			103/M1/A15-D/V30(N)					
			103/M1/V32(N)					

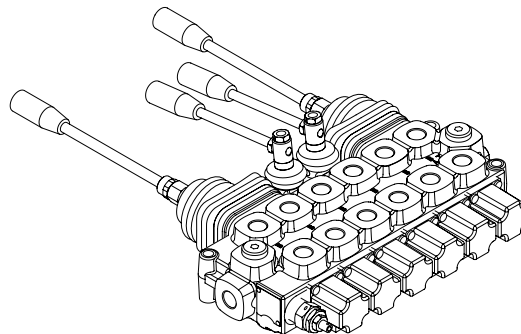

Schema idraulico  
Hydraulic symbol

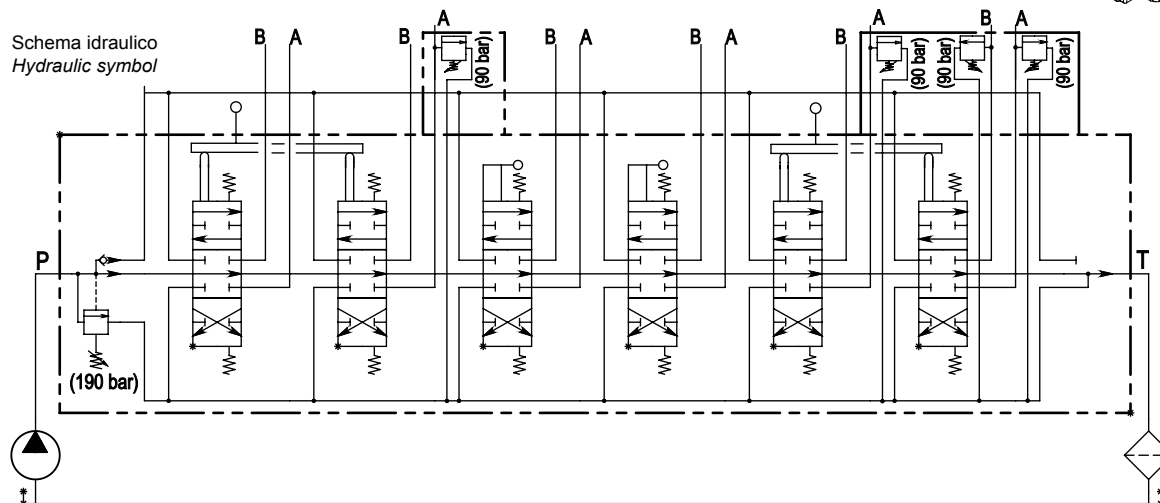

- A - Tipo / Type
- B - Fiancata d'ingresso / Inlet section
- C - Sezione di lavoro / Working section
- D - Fiancata di scarico / Outlet section
- E - Note aggiuntive / Additional notes

ESEMPI DI ORDINAZIONE IN CODICE  
ORDERING CODE EXAMPLES

Q25 - F1S(N) - 4x103/H5 - F6D - 4E

A	B	C	D	E
1	2 3	4 - 5 - 6	7	8 - 9
Q25	F1S N180 4x	103/H5	F6D	4E

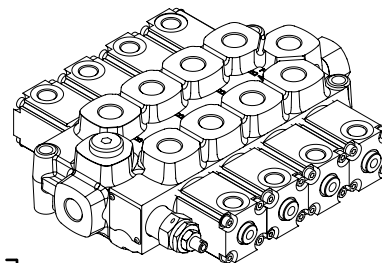

Schema idraulico  
Hydraulic symbol

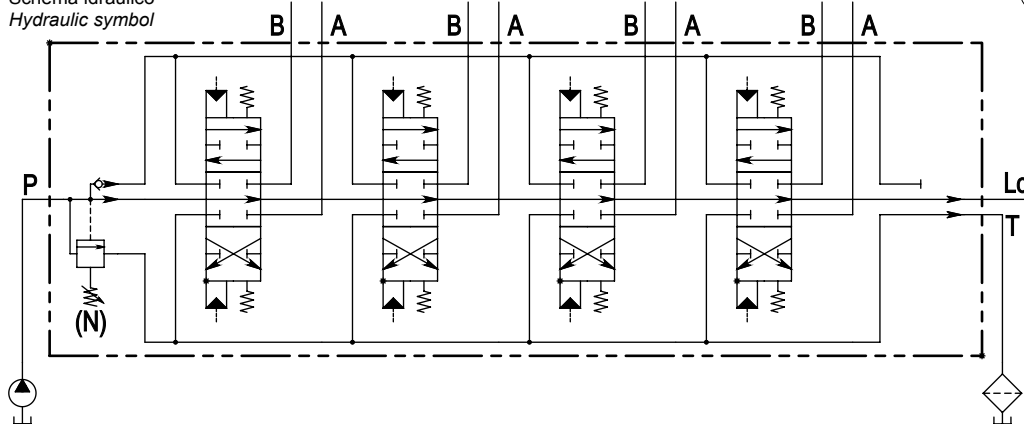

Q45 - F1S(N) - 103/A8/M1 - 116/A8-Z1/R8 - F3D - 2E

A	B	C	D	E
1	2 3	4 - 5 - 6	7	8 - 9
Q45	F1S R250	103/A8/M1 116/A8-Z1/R8	F3D	2E

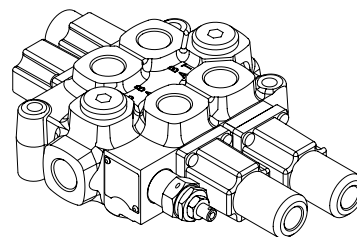

Schema idraulico  
Hydraulic symbol

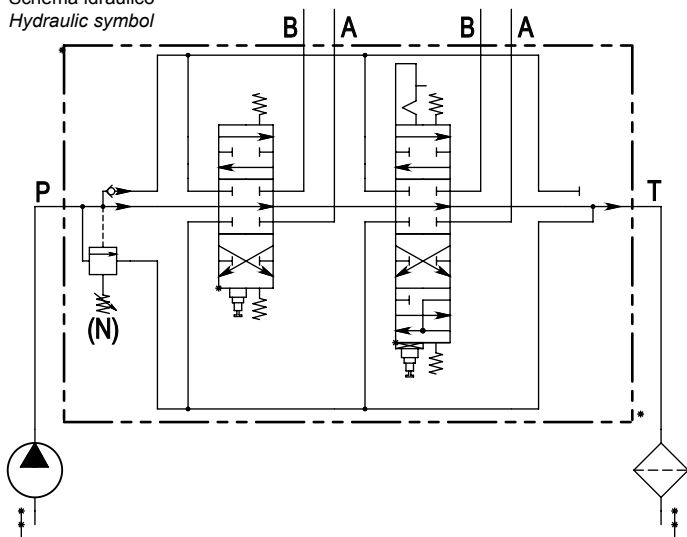

- A - Tipo / Type
- B - Fiancata d'ingresso / Inlet section
- C - Sezione di lavoro / Working section
- D - Fiancata di scarico / Outlet section
- E - Note aggiuntive / Additional notes

ESEMPI DI ORDINAZIONE IN CODICE  
ORDERING CODE EXAMPLES

Q25 - F1S (N) - 111/A1/D3 - 2x103/A1/D3 - 3x103/A1/M1 - F3D - S 24V - 6E

A	B		C			D	E	
1	2	3	4 - 5 - 6			7	8 - 9	
Q25	F1S	N180	111/A1/D3			F3D	S 24V - 6E	
			2x 103/A1/D3					
			3x 103/A1/M1					

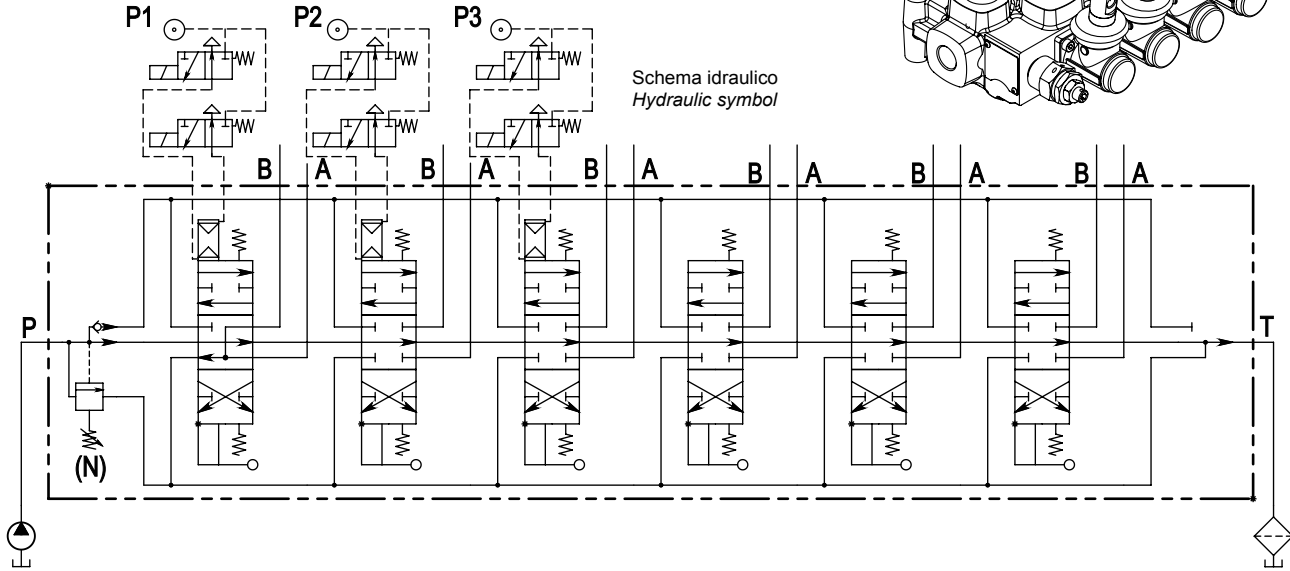
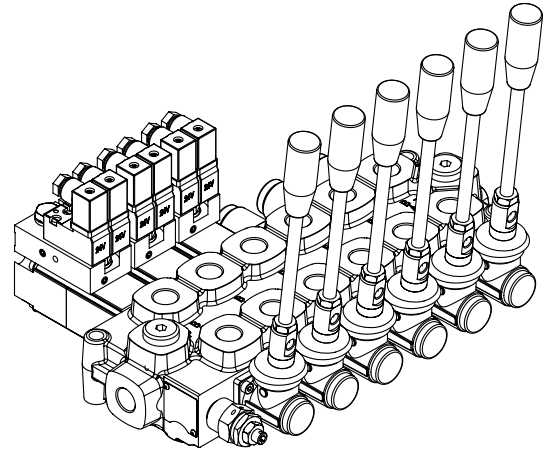

Q75 - F8S(N) - 3x103/A4/M1 - F6D - 3E

A	B		C			D	E	
1	2	3	4 - 5 - 6			7	8 - 9	
Q75	F8S	N180	3x 103/A4/M1			F6D	3E	

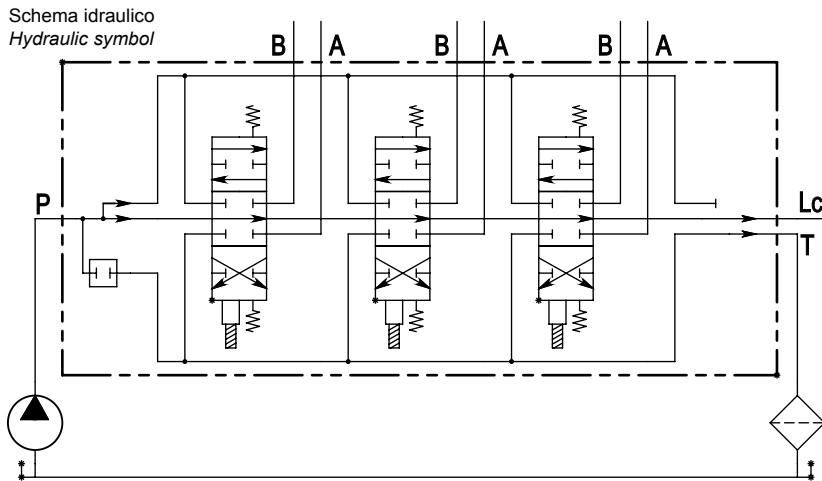
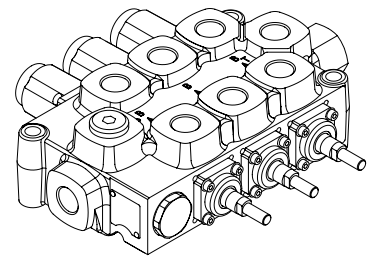

- A - Tipo / Type
- B - Fiancata d'ingresso / Inlet section
- C - Sezione di lavoro / Working section
- D - Fiancata di scarico / Outlet section
- E - Note aggiuntive / Additional notes