



Specification & Installation instruction



Feature:

- Clutch for manual adjustments.
- Maintenance free.
- Position indicator.
- Control signal fully programmable.
- Fail safe by *Enerdrive System*¹ (on model 060 & 080).
- Auxiliary switches (on model 020 & 080).

Old Number

TBM4000A	TM000
TBM4021A	TM020
TBM4060A	TM060
TBM4080A	TM080
RBM6000A	RM000
RBM6021A	RM020
RBM6060A	RM060
RBM6080A	RM080

Technical Data	TM000 <i>TBM4000A</i>	TM020 <i>TBM4021A</i>	TM060 <i>TBM4060A</i>	TM080 <i>TBM4080A</i>	RM000 <i>RBM6000A</i>	RM020 <i>RBM6021A</i>	RM060 <i>RBM6060A</i>	RM080 <i>RBM6080A</i>
Auxiliary switches	No	Yes(2)	No	Yes(2)	No	Yes(2)	No	Yes(2)
Fail safe - <i>Enerdrive</i>	No		Yes		No		Yes	
Power consumption	8VA		30VA Peak, 8VA		10VA		30VA Peak, 10VA	
Torque	180 in.lb. [20 Nm] at rated voltage				360 in.lb. [40 Nm] at rated voltage			
Weight	4.5 lbs. [2 kg]				7 lbs. [3.2 kg]			
Running time through 90°	60 to 85 sec torque dependant							
Feedback	4 to 20 mA or 2 to 10 VDC adjustable							
Power supply	28 to 32 VDC or 22 to 26 VAC							
Electrical connection	18 AWG [0.8 mm ²] minimum							
Inlet bushing	2 inlet bushing of 7/8 in [22.2 mm]							
Control signal	Analog, Digital or Pulse with modulation (PWM) programmable (factory set with Analog control signal)							
Angle of rotation	0 to 90 degrees, electronically adjustable (factory set with 90° stroke)							
Direction of rotation	Reversible, Clockwise (CW) or Counterclockwise (CCW) (factory set with CW direction)							
Ambient temperature	0°F to +122°F [-18° C to +50° C]							
Storage temperature	-22°F to +122°F [-30° C to +50° C]							
Relative Humidity	5 to 95 % non condensing.							

Warning: Do not press the clutch when actuator is powered

Dimensions

Dimension	Inches	Metric (mm)
A	5.20	132.1
B	1.33	33.8
C	9.13	231.9
D	3.55	90.2

Caution

We strongly recommend that all neptronic® products be wired to a separate transformer and that transformer shall service only neptronic® products. This precaution will prevent interference with, and/or possible damage to incompatible equipment.

When multiple actuators are wired on a single transformer, polarity must be observed. Long wiring runs create voltage drop which may affect the actuator performance.

¹ Enerdrive System U.S.A. Patent #5,278,454



Mechanical installation

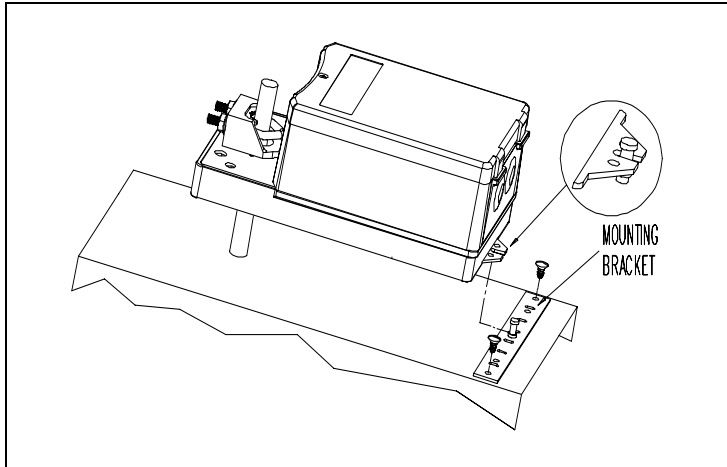

1. Manually close the damper blades and positioned the actuator at 0° or 90°.
2. Slide the actuator onto the shaft.
3. Tighten the nuts on the “U” bolt to the shaft with a 10mm wrench to a torque of 150 in.lb. [17 Nm].
4. Slide the mounting bracket under the actuator. Ensure free movement of the slot at the base of the actuator. The bracket pin must be placed in the mid distance of the slot.
5. Fix the bracket to the ductwork with #8 self-tapping screws.

Wiring Diagrams

Analog

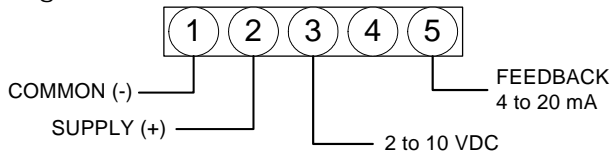

For 4 to 20 mA control signal

Connect one of the supplied 500 ohm resistors between pins 1 and 3.

PWM

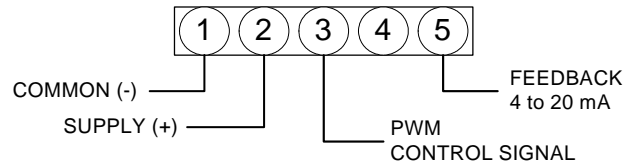

Digital – 3 wire / 2 position

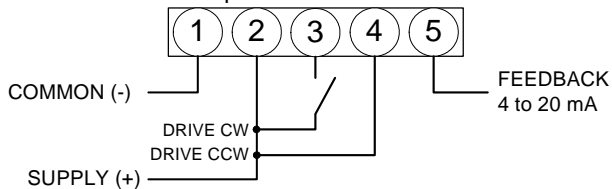

Special consideration for Digital control

In this mode, actuator is sensitive to induced electrical voltages from other sources. To prevent such interference, wire one 2.2k ohm 0.5W resistor between pins 4 and 1 and a second 2.2k ohm 0.5W resistor between pins 3 and 1. These resistors are supplied.

Digital – 4 wire / 3 point floating

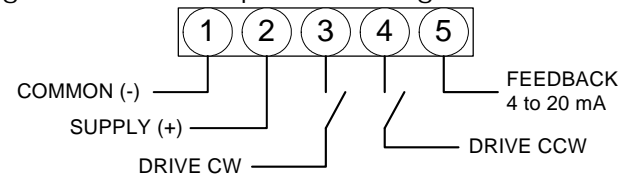

For 2 to 10 VDC output feedback

For any of above wiring configurations, connect one of the supplied 500 ohm resistors between pins 1 and 5 .

PC Board

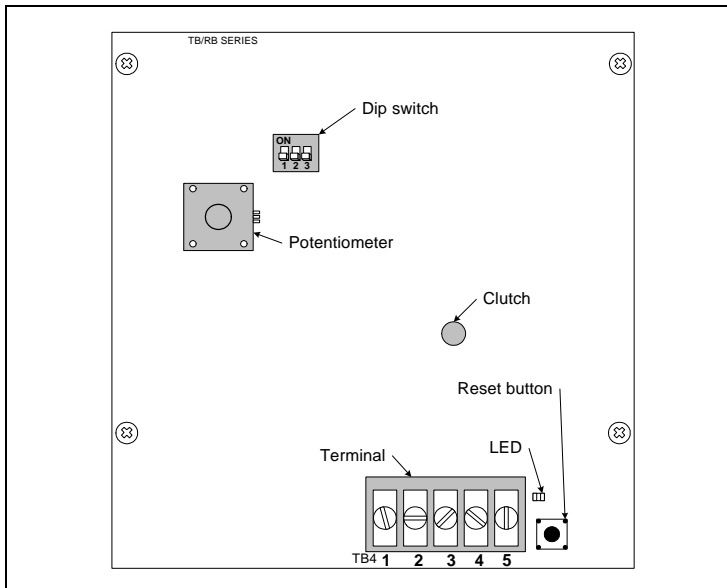

Dip switch settings

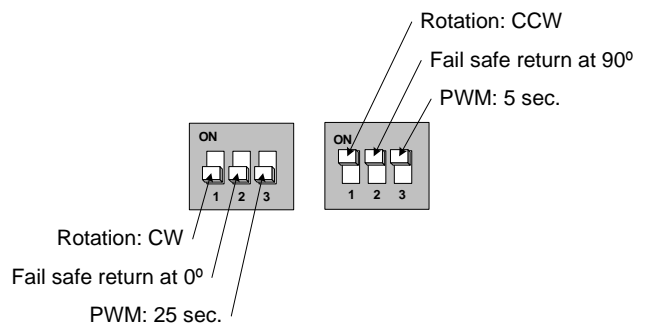

Stroke adjustment – No control signal change

1. Apply power and, **wait for at least 10 seconds**.
2. Press and release the reset button to start the auto-stroke process.
The LED should be illuminated.
 - First option:
The actuator will then travel in both directions to find its limit and position itself according to the demand.
The LED will extinguish, the process is complete.
 - Second option:
When the desired end position is reached, press and release the reset button. The actuator will now return back to its original position. (you can also press and release the reset button when it reaches the original position)
The LED will extinguish, the process is complete.

Programming – Change of control signal

1. Remove power and put all dip switches "OFF". (factory preset).
2. Apply power and, **within 10 seconds**, press and release the reset button. The LED should be blinking.
3. Select the control signal with dip switches:
 - **Digital** (On/Off or 3 point floating)
move switch **No1** "ON" and then "OFF".
 - **PWM**
move switch **No2** "ON" and then "OFF".
 - **Analog** (factory preset)
move switch **No3** "ON" and then "OFF".
4. Stroke adjustment
see the stroke adjustment section above.

Note, if PWM mode is selected:

- Time base : When programming is done,
if switch No3 is "on" time base is 0.1 to 5 sec. (resolution 20 msec.)
if switch No3 is "off" time base is 0.1 to 25 sec. (resolution 100 msec.)
* For 5 sec. time base, we strongly recommend a switch common connection for better position stability.
- Switch 24 VAC: Triac or dry contact, 40mA maximum switching current.
- Switch common: NPN transistor, SCR, Triac or dry contact 75mA maximum switching current.

Feedback selection (CCW direction)

To select CCW direction put switch No1 "ON".

In Analog or 3 point floating mode you can program the feedback control.

If switch No3 is "OFF":

The feedback control is automatically reverse to 4 to 20 mA for 90 to 0 degrees.

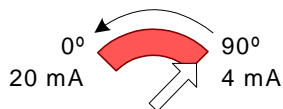

If switch No3 is "ON":

The feedback control is to 20 to 4 mA for 90 to 0 degrees.

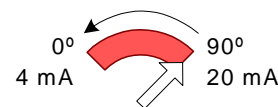

Zero and span calibration

This feature is applicable to analog control signal only.

1. Remove power and put all dip switches "OFF". (factory preset).
2. Apply power and, **within 10 seconds** press and hold the reset button until the LED blinks once.
The Zero and span calibration process then start.
3. Release the reset button. The LED is now constantly illuminated.
4. Apply new minimum voltage.
It can be any value between 0 to 7 VDC, with an external 0 to 10 volt supply (ex: MEP).
5. Press and release the reset button to memorize the new minimum voltage. The LED blinks once.
6. Apply new maximum voltage.
It can be any value between 3 to 10 VDC, this value should be greater than the new minimum value.
7. Press and release the reset button to memorize the new maximum voltage. The LED blinks once.
The Zero and span calibration process is complete.

Note: To reset zero and span to 2 to 10 VDC (factory value). You just have to re-select the analog control signal mode, see Programming.

