

DUPLEX Type

the best choice for applications involving highly oxidizing agents and halogens

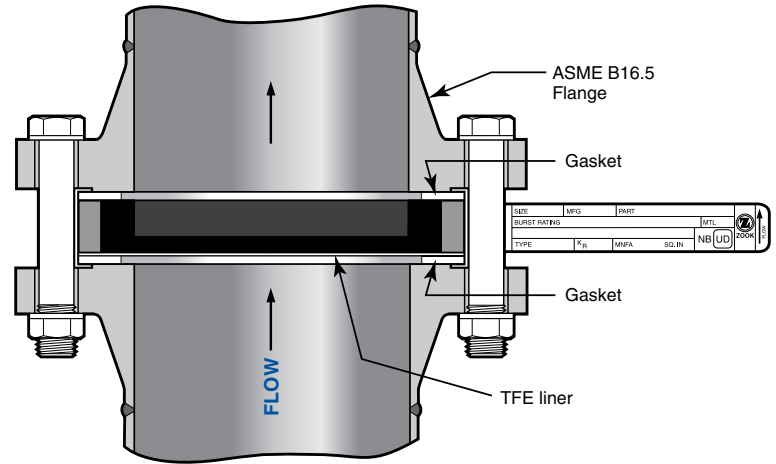

- Disks extend corrosion resistance by utilizing a liner on the flat surface of the disk that contacts the process media
- Disks are capable of resisting virtually any corrosive except elemental free fluorine
- Sizes 1/2" thru 24" diameters
- Designed to fit ASME B16.5 Class 150 and 300 flanges
- Burst ratings 0.50 to 1000 psig or higher
- 0% manufacturing range
- Operating pressures to 90% of the disk's marked burst pressure (Contact ZOOK for operating ratio for burst pressures below 15 psig)
- Temperature ratings -290°F to +700°F (-179°C to +371°C) Maximum temperature rating without insulation is 430°F (221°C) or 700°F (371°C) with insulation. Contact ZOOK for higher temperature ratings. The specified temperature shall be at the disk location at the time when the disk is expected to rupture
- External type vacuum supports are available for vacuum service (Contact ZOOK when vacuum is present)
- ASME B16.5 Class 300 disks are armored
- ASME UD marking available



Certified Flow Resistance Factor (K_{rgl})

Type	K_{rgl}
DUPLEX	0.64

Specifications – ASME B16.5 Class 150

Nominal Disk Sizes	Minimum net flow area (MNFA) sq. inches	Disk Dimensions				Burst Ratings psig	
		Diameter		Thickness*		Min.	Max.
		I.D.	O.D.	Standard Disk	Insulated Unit		
1/2"	0.30	0.622"	1-3/4"	5/8"	1-3/4"	25	above 1000
3/4"	0.53	0.824"	2-1/8"	5/8"	1-3/4"	25	above 1000
1"	0.78	1"	2-1/2"	7/8"	2-1/4"	10	above 1000
1-1/2"	1.76	1-1/2"	3-1/4"	7/8"	2-1/4"	7	1000
2"	3.14	2"	4"	7/8"	2-1/4"	3	300
3"	7.06	3"	5-1/4"	7/8"	2-1/4"	2	300
4"	12.56	4"	6-3/4"	7/8"	2-1/4"	1.5	250
6"	28.27	6"	8-5/8"	7/8"	2-1/4"	1	170
8"	50.26	8"	10-7/8"	1-1/8"	2-3/4"	0.75	170
10"	78.53	10"	13-1/4"	1-1/2"	3-3/8"	0.50	150
12"	113.09	12"	16"	2"	4-3/8"	0.50	150
14"	137.88	13-1/4"	17-5/8"	2-1/4"	4-7/8"	0.50	150
16"	182.65	15-1/4"	20-1/8"	2-1/2"	5-3/8"	0.50	150
18"	233.70	17-1/4"	21-1/2"	2-3/4"	5-7/8"	0.50	below 150
20"	291.03	19-1/4"	23-3/4"	3"	6-3/8"	0.50	below 150
24"	424.55	23-1/4"	28-1/8"	3"	6-3/8"	0.50	below 150

Specifications – ASME B16.5 Class 300

1/2"	0.30	0.622"	2"	5/8"	1-3/4"	25	above 1000
3/4"	0.53	0.824"	2-1/2"	5/8"	1-3/4"	25	above 1000
1"	0.78	1"	2-3/4"	1"	2-1/2"	10	above 1000
1-1/2"	1.76	1-1/2"	3-5/8"	1"	2-1/2"	7	1000
2"	3.14	2"	4-1/4"	1"	2-1/2"	3	500
3"	7.06	3"	5-3/4"	1-1/4"	3"	2	500
4"	12.56	4"	7"	1-1/4"	3"	1.5	500
6"	28.27	6"	9-3/4"	1-3/4"	4"	1	450
8"	50.26	8"	12"	2-1/4"	5"	0.75	450

*Standard disk thickness does not include gaskets. Insulated unit thickness includes all gaskets
 Note: Maximum pressure rating of ASME B16.5 Class 150 flanges is 290 psig @ 100°F (38°C). ASME B16.5 Class 300 flanges is 750 psig @ 100°F (38°C). The maximum pressure rating is lower at higher temperatures. Reference ASME/ANSI B16.5