



# CE series

Ø 20 mm cylindrical capacitive sensors



Ø 20 mm cylindrical

## features

- Models with or without self-monitoring
- Sensitivity adjustment with trimmer
- NO+NC complementary output
- Stainless steel housing
- IP65 protection degree
- Complete protection against electrical damages
- Axial cable exit or M12 plastic plug cable exit

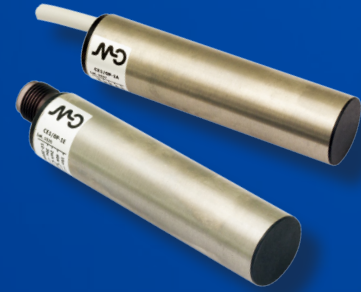

## web contents



- Application notes
- Photos
- Catalogue / Manuals



## code description

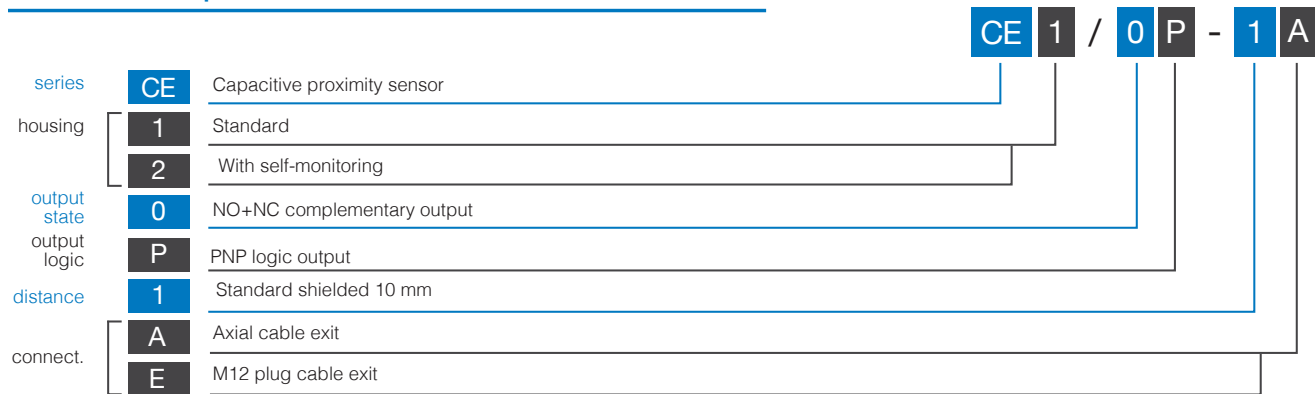

## available models

diameter	installation	distance (mm)	plug	self-monitoring	PNP/NO + NC
Ø 20	shielded	10	cable	-	CE1/0P-1A
			M12	-	CE1/0P-1E
			cable	•	CE2/0P-1A
			M12	•	CE2/0P-1E

	CE1/0P-1*	CE2/0P-1*
		
nominal sensing distance $S_n$	10 mm	
operating distance	1.5...7.2 mm (shielded)	
hysteresis	2...15%	
repeatability	5%	
supply voltage	10...30 Vdc	
ripple	≤ 15%	
no-load supply current	17 mA	
load current	≤ 100 mA	
leakage current	≤ 1 µA	
voltage drop	1.5V max. $I_L=100$ mA	
output type	PNP NO+NC - open collector	
switching frequency	300 Hz	
self-monitoring pulse frequency	period 4-8 ms (6,2 ms nominal) duration 150-300 µs (220 µs nominal)	
power supply protections	polarity reversal, transient	
output protection	short circuit (autoreset)	
temperature range	-25°...+70°C	
temperature drift	20% Sr	
EMC	in conformity with the EMC Directive, according to IEC 60947-5-2	
shocks and vibrations	IEC 60947-5-2	
protection degree	IP 65	
LEDs	yellow (NO output energized)	
housing material	stainless steel	
active head material	LCP	
weight	80 g M12 connector / 200 g cable	

## electrical diagrams of connections

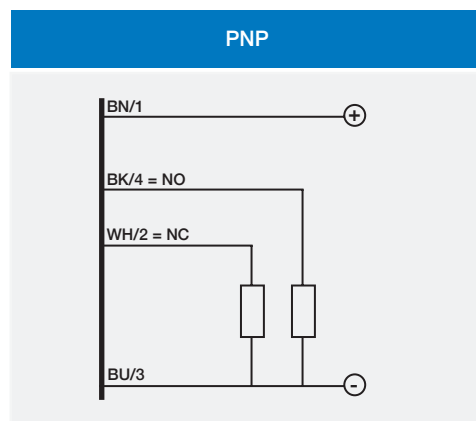

- BN** brown
- BU** blue
- BK** black
- WH** white



M12 - NO+NC

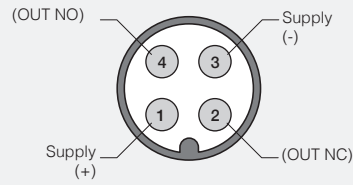

response diagram

detection area

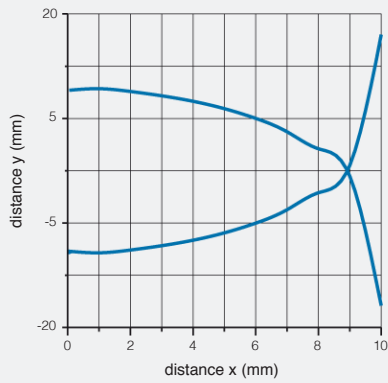

sensitivity adjustment

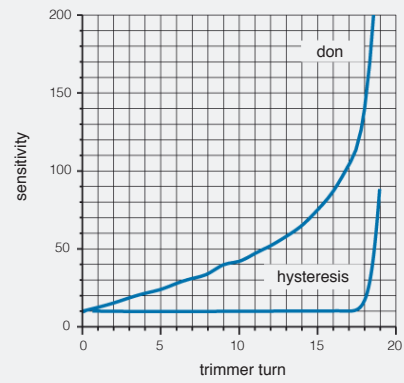

dimensions (mm)

CE\*/0\*-1A

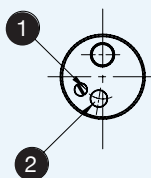
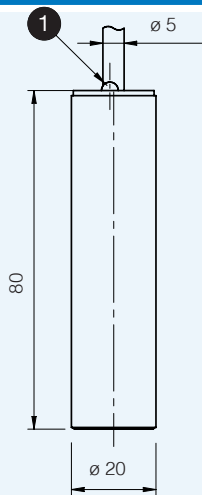

CE\*/0\*-1E

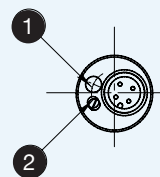
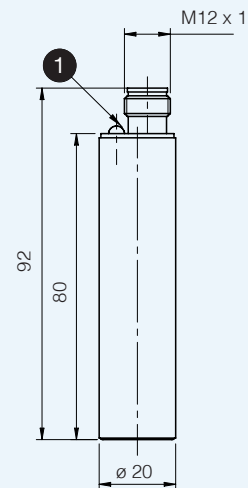

- 1 LED
- 2 TRIMMER