

Control Unit

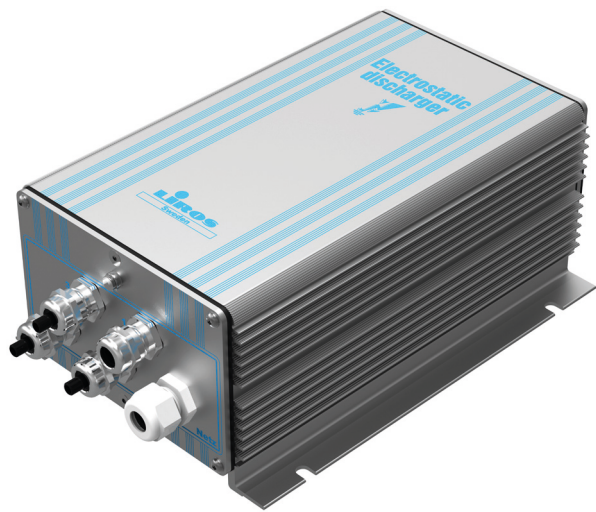

NS10D high efficiency, low-loss control unit.

- 4 outputs.
- Cable length per output: ≤ 20 meters.
- Effect: Adjustable.
- Input voltage: 230VAC, 50-60Hz or 115VAC, 50-60Hz.
- Output voltage: Pulsating DC, $U^{\wedge}=350V$.
- Pulse width: Circa 10ms.
- Frequency: Adjustable, 170Hz to 440Hz.
- Remote: 5-30VDC, 4.7k Ω , optically isolated.
- Power consumption: Max. 50VA.
- IP 54.

High Voltage Units

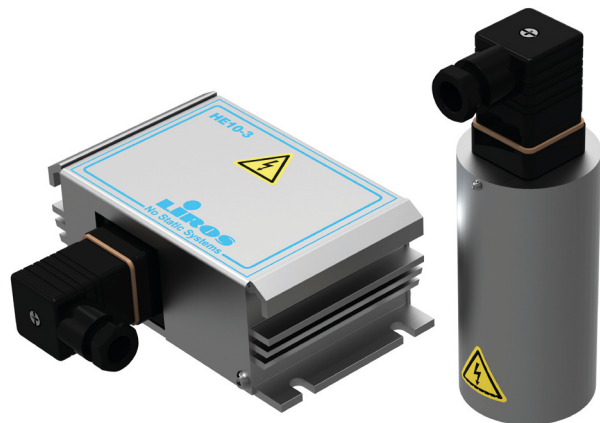

HE10-1 and HE10-3 high voltage units.

- 1 (HE10-1) or 3 (HE10-3) outputs.
- Converts the pulses from the NS10D control unit to high voltages.
- Output voltage: Appr. 27kV~.
- Cable length between high voltage unit and ionizer: ≤ 5 meters.

Dimensions

HE10-1

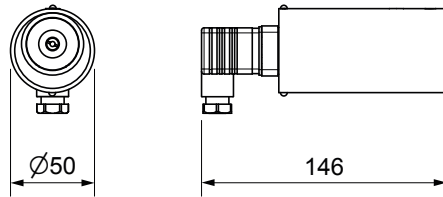

NS10D

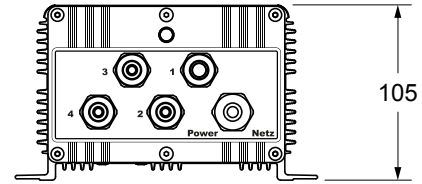

HE10-3

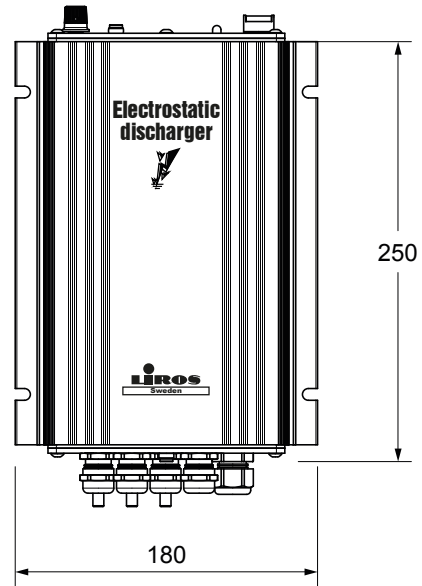
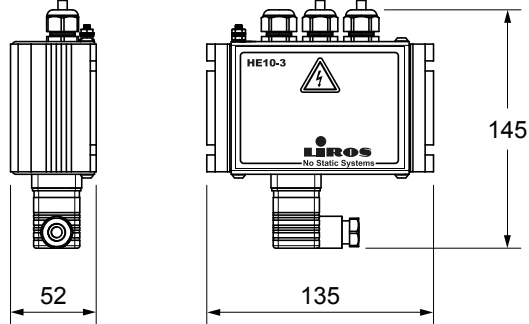

SEPH/10

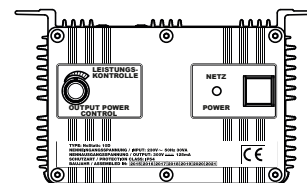
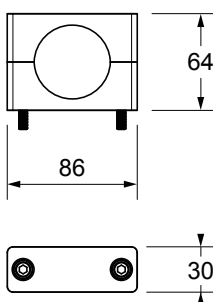

Parts List

NS10D Control Unit with 4 Outputs

230VAC/50Hz

Order No.: LI 13 10 07 (ionizers < 1 m)

Order No.: LI 13 10 08 (ionizers 1 to 3 m)

Order No.: LI 13 10 09 (ionizers > 3 m)

HE10-1 High Voltage Plug-in Unit with 1 Output

Order No.: LI 13 10 70

HE10-3 High Voltage Plug-in Unit with 3 Outputs

Order No.: LI 13 10 73

SEPH/10 Mounting Bracket for HE10-1

Order No.: LI 11 90 10

SKHE/10 Signal Cable with Connector for High Voltage Unit

2000 mm, Order No.: LI 15 31 20

5000 mm, Order No.: LI 15 31 50

9000 mm, Order No.: LI 15 31 90

SEKR/03 High Voltage Cable

500 mm, Order No.: LI 12 03 05

1500 mm, Order No.: LI 12 03 15

3000 mm, Order No.: LI 12 03 30

5000 mm, Order No.: LI 12 03 50

