

VT	Datenblatt	
	Data sheet	

Type **F 1400-6-7.0**
Type **FHE 1400-6-7.0**
Type **FT 1400-6-7.0**
Type **FTHE 1400-6-7.0**

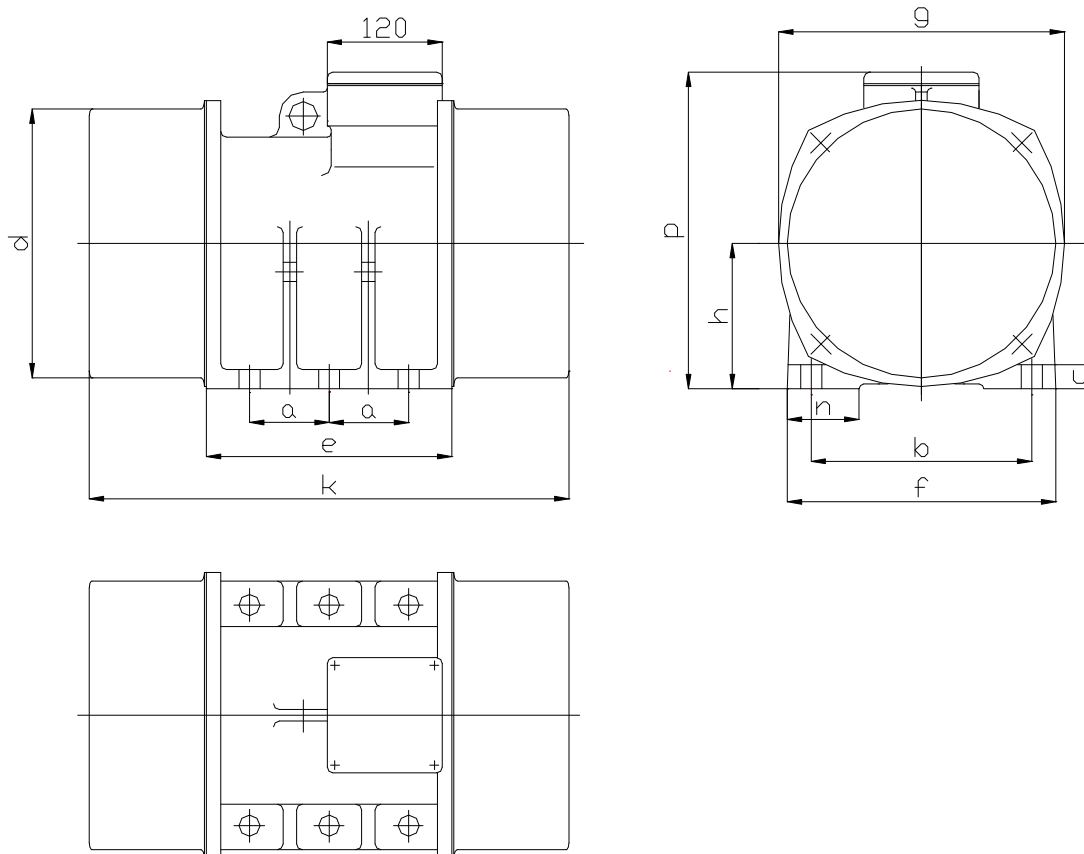

Maße / Dimensions [mm]

a	b	c	d	e	f	g	h	k	n	p
118	280	30	320	370	340	340	185	910	90	390

Technische Daten / Technical data

Spannung Voltage	Frequenz Frequency	Leistungs- aufnahme Power consumption	Nennstrom Nominal current	Leistungsfaktor Power factor	Anzugsmoment Starting current ratio
[V]	[Hz]	[kW]	[A]	cos φ	I_A / I_N
220/380	50	4,00	15,04/8,71	0,84	7,5

Fliehkraft Centrifugal force	Arbeitsmoment Working moment	Befestigungs- Schrauben Hexagon screw	Gewicht weight
[N]	[kgcm]		[kg]
76770	1400	8.8 6 x M24	296