

Surface differential controller, 230 V, 2 relays

Thermostat designed to display, control and regulate thermal solar energy applications in domestic hot water facilities.

1- Versions and references

MODEL	FUNCTION	RELAY	POWER SUPPLY, 50/60 Hz
AKO-14801	Controller	R1 (Pump): 16 A, 250 V, cos φ=1 SPST R2 (Fan / Support Resistance): 8 A, 250 V, cos φ=1 SPDT	230 V~ ±10%

2- Technical data

Temperature range according to type of sensor configured:

NTC-50.0 °C to 99.9 °C (-58.0 °F to 211 °F)
 PTC-50.0 °C to 150 °C (-58.0 °F to 302 °F)
 Resolution, Set Point and differential:0, 1 or 1 °C/°F configurable by parameter P7
 Input for probe:

NTCAKO-149XX
 PTCAKO-1558XX

Thermometric accuracy:± 1 °C
 Probe tolerance at 25 °C:

NTC± 0,4 °C
 PTC± 1.25 °C

Maximum input power:5 VA
 Working ambient temperature:5 °C to 50 °C
 Storage ambient temperature:-30 °C to 70 °C

Control device classification:
 Independent mounting, with characteristic of automatic operation Type 1.B action, to be used in a clean situation, logical medium (software) class A and continuous operation.
 Degree of contamination 2 on UNE-EN 60730-1

Double insulation between the power supply, the secondary circuit and the relay output.
 Allocated pulse temperature:2500 V
 Pressure ball test temperature:
 Accessible parts:75 °C
 Parts that position active elements:125 °C
 Voltage and current declared by the EMC tests:207 V, 21 mA
 Current of radio jamming suppression test:270 mA

3- Installation

The controller should be installed in a place protected from vibrations, water and corrosive gases, and where ambient temperature does not surpass the value specified in the technical data.

In order to give a correct reading, the probe should be installed in a place without heat influences other than the temperature that is to be measured or controlled

3.1 Fastening:

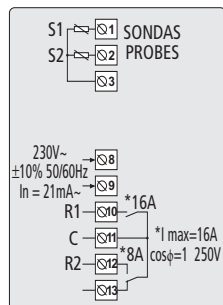
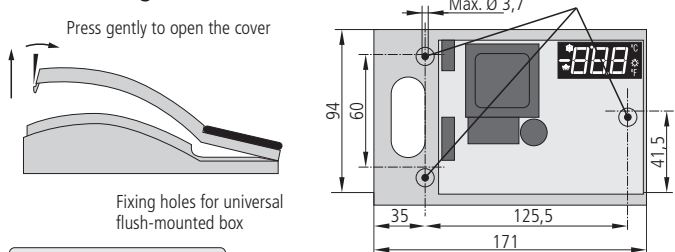

3.2 Connection:

The probe and its lead should NEVER be installed in ducting along with power, control or power supply wiring.
 The power supply circuit should be connected with a minimum 2 A, 230 V, switch located close to the unit. Power supply cables should be H05VV-F 2x0,5 mm² or H05V-K 2x0,5 mm².
 Section of connecting wires for relays contacts should be 2,5 mm².

4- Front panel functions

LED (Pump R1)
Permanent: Pump Relay 1 energised.
LED (Fan R2 if P0=0)
Permanent: Fan Relay 2 energised.

LED (Support Resistances R2 if P0=1)
Permanent: Support Resistances Relay 2 energised.
LED Alarm
Permanent: Alarm indicator enabled.
Flashing: Alarm detected, but display maintained.

LED °C

Permanent: Degrees °C indicator.

Flashing: Programming phase.

LED °F

Permanent: Degrees °F indicator.

Flashing: Programming phase.

UP key ▲

- Press once to cancel the alarms, but they remain displayed.
- Press to display the value of the second probe for five seconds.
- In programming, it makes the displayed value increase.

DOWN key ▼

- Press once to cancel the alarms, but they remain displayed.
- In programming, it makes the displayed value reduce.
- In the test mode it manually enables/ disables the two relays R1 and R2. Display shows **tSt**.

RIGHT key ►

- Press once to cancel the alarms, but they remain displayed.
- In programming, it makes the level value increase.
- In the test mode it manually enables/ disables the R1 relay. Display shows **tSt**.

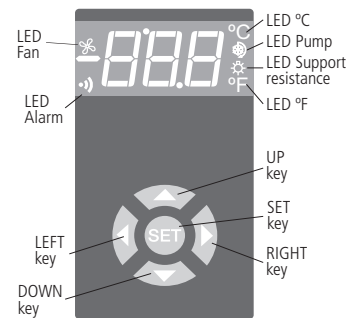

LEFT key ◀

- Press once to cancel the alarms, but they remain displayed.
- Exit programming level.
- In the test mode it manually enables/ disables R2 relay. Display shows **tSt**.

SET key

- Press once to cancel the alarms, but they remain displayed.
- In programming, accept the programmed new value.
- When pressed it displays the help message **SP1** corresponding to the function performed by the key.
- When pressed for at least 5 seconds, the **Solar Set Point** temperature (SP1) is displayed.

5- Adjustment and configuration

It should only be programmed or modified by personnel who are fully conversant with the equipment operation and possibilities.

5.1 Set Point temperature

The factory SOLAR SET POINT default value is 2.0 °C.

- Press **SET** key for at least 5 seconds to DISPLAY SOLAR SET POINT. The display shows **SP1** for five seconds. It displays the CURRENT SET POINT value and LED °C or °F starts flashing.
 - Press **▲** or **▼** keys to CHANGE SET POINT into the required value.
 - Press **SET** key to ACCEPT THE NEW SET POINT. The display returns to the CURRENT TEMPERATURE display status and LED °C or °F stops flashing.
 - Press the **◀** key to exit the temperature set point without modifying the value.
- When **PA** is displayed, PASSWORD programmed in L5 parameter of **tid** menu should be entered to access the CURRENT SET POINT.
- Press **►** key, **0** will be displayed to ENTER PASSWORD.
 - Press **▲** or **▼** keys to CHANGE NUMBER and DISPLAY PASSWORD programmed.
 - Press **SET** key to ACCEPT PASSWORD. The CURRENT SET POINT value will be displayed and it can be already modified.

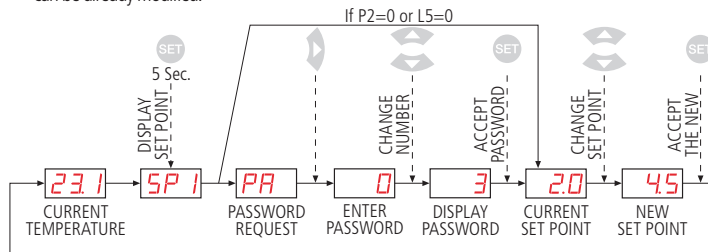

5.2 Parameters configurations

Level 1 Menus

- When the keys **▲** + **▼** are pressed simultaneously for at least 10 seconds, the display shows **Pro** for 10 seconds. LED °C or °F will be flashing, we are in the programming LEVEL 1 MENUS and the first menu "r1" is displayed.
 - Press **▲** key to access the next menu and **▼** key to return to previous one.
 - Pressing **◀** key, the controller returns to the CURRENT TEMPERATURE display status and LED °C or °F will stop flashing.
- When **PA** is displayed, PASSWORD programmed in L5 of "tid" menu should be entered to access programming LEVEL 1 MENUS.
- Press **►** key, 0 will be displayed to ENTER PASSWORD.
 - Press **▲** or **▼** keys to CHANGE NUMBER and DISPLAY PASSWORD programmed.
 - Press **SET** key to ACCEPT PASSWORD. The first menu "r1" will be displayed.

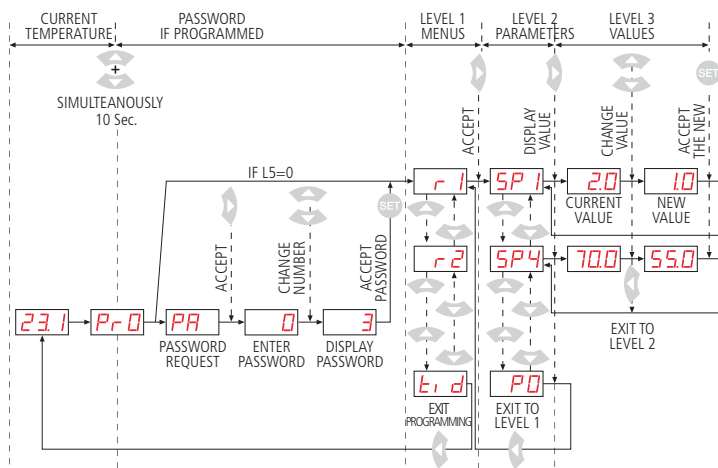

Level 2 Parameters

- In the desired menu of LEVEL 1 MENUS, press **▶** key. LEVEL 2 PARAMETERS programming is accessed. The first parameter of the selected menu is displayed on the screen.
- Press **▲** key to access the next parameter and key to return to the previous one.
- Pressing **◀** key, the controller returns to the LEVEL 1 MENUS.

Level 3 Values

- To DISPLAY the CURRENT VALUE of any parameter, select the required one and press **▶** key. Once it is displayed, you can CHANGE VALUE, pressing **▲** or **▼** key.
- Press **SET** key to ACCEPT THE NEW. The programming returns to LEVEL 2 PARAMETERS.
- Pressing **◀** key, the controller returns to the LEVEL 2 PARAMETERS.

REMARK: If no key is pressed for 25 seconds in either of the previous steps, the controller will automatically return to the CURRENT TEMPERATURE display status without modifying any of the parameters values.

6- Description of parameters and messages

Values in the **Def.** column are factory-set.

r1	Level 2	Level 3	Description	Values	Min.	Def.	Max.
Level 1 Menus and Description							
r1 Level 2 Pump Control (Relay R1)							
	Level 3	Description	Values	Min.	Def.	Max.	
	SP1	Solar Set Point	(°C/°F)	LL1	7.0	HL1	
	di1	Solar Differential (Hysteresis)	(°C/°F)	1.0	3.0	5.0	
	CA1	Sensor 1 calibration (Offset)	(°C/°F)	-20.0	0.0	20.0	
	HL1	Solar set point upper limit (It cannot be set above this value)	(°C/°F)	LL1	15.0	30.0	
	LL1	Solar set point lower limit (It cannot be set below this value)	(°C/°F)	0.0	3.0	HL1	
	toF	Minimum time for pump (R1)	(Sec.)	0	10	255	
	AHF	Panels de-icing temperatura (0=Disabled) (1=Enabled)		0	0	1	
	SP2	Panels De-Icing Temperature	(°C/°F)	-9.0	5.0	50.0	
	di2	Panels De-Icing Differential (Hysteresis)	(°C/°F)	1.0	2.0	5.0	
	SP3	Maximum Temperature in Panels	(°C/°F)	0.0	95.0	302	
	di3	Panels De-Icing Differential (Hysteresis)	(°C/°F)	1.0	2.0	5.0	
	Pr1	Relay 1 polarity (Pump) (0=Normally open) (1=Normally closed)		0	0	1	
r2 Level 2 Fan Control or Support Resistances (Relay R2)							
	Level 3	Description	Values	Min.	Def.	Max.	
	SP4	Support resistance adjustment temperature through probe 2	(°C/°F)	0.0	40.0	212	
	di4	Support Resistance Differential (Hysteresis)	(°C/°F)	1.0	2.0	5.0	
	CA2	Sensor 2 calibration (Offset)	(°C/°F)	-20.0	0.0	20.0	
	tAC	Maximum temperature function in tank through probe 2 (0=Disabled) (1=Enabled)	(°C/°F)	0	0	1	
	SP5	Maximum Temperature in Tank	(°C/°F)	0.0	70.0	212	
	di5	Tank maximum temperature diferencial (Hysteresis)	(°C/°F)	1.0	2.0	5.0	
CnF Level 2 GENERAL STATUS							
	Level 3	Description	Values	Min.	Def.	Max.	
	P0	Relay R2 function type (0=Fan) (1=Support resistances)		0	0	1	
	P2	Test and SP1 keys disabled (0 = No) (1 = Test key disabled) (2 = Test + SP1 keys disabled)		0	0	2	
	P3	Initial parameters: (1=Yes, configure to "Def" and exit programming)		0	0	1	
	P5	Address for units with communication		0	0	255	
	P7	Temperature display mode: (0=Integers in °C) (1=One decimal in °C) (2=Integers in °F) (3=One decimal in °F)		0	1	3	
	P8	Sensor to be displayed (1=Sensor 1) (2=Sensor 2)		1	1	2	
	P9	Sensor 1 type selection (0 = NTC) (1 = PTC)		0	0	1	

tid	Level 2	Level 3	Description	Values	Min.	Def.	Max.
	L5	Access password to parameters and information			0	0	255
	L6	Parameters transfer: (0=Disabled) (1=Send) (2=Receive)			0	0	2
	PU	Program version (Information)					

MESSAGES							
PA	Password request to enter programming parameters or SOLAR SET POINT (SP1)						
Ht1	Flashing with temperature - Over Temperature in Probe 1 ≥ SP3 (Maximum Temperature in Panels)						
Ht2	Flashing with temperature - Over Temperature in Probe 2 ≥ SP5 (Maximum Temperature in tank)						
Lt1	Flashing with temperature - Low Temperature in Probe 1 ≤ SP2 (Maximum Temperature in Panels)						
tSt	Test mode. R1, R2 manually enabled.						
CPY	Parameters received from the parameters server.						
E1	Sensor 1 failure (Open circuit, crossed, NTC temp.> 110°C or temp.<-55°C PTC temp.> 150°C or temp.<-58°C)						
E2	Sensor 2 failure (Open circuit, crossed, NTC temp.> 110°C or temp.<-55°C)						
EE	Memory failure						

7- Parameters transfer

Portable server

AKO-14918 portable server, with no power supply, in which parameters programmed in a powered controller can be copied by transfer. Parameters can be transferred again from the server to other identical powered controllers.

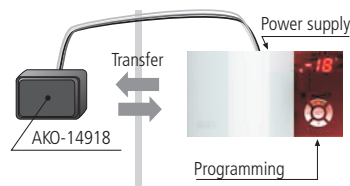

Storage dump or fast copy of the parameters entered in the portable server to the controller:

Press the key **▶** while the controller is being connected to the power supply until the display shows **CPY**, indicating that the transfer was made correctly. Disconnect the controller and reconnect it to the power supply. Storage dump can also be done from parameter L6=2.

8- Maintenance

Clean the controller surface with a soft cloth, soap and water. Do not use abrasive detergents, petrol, alcohol or solvents.

9- Warnings

The use of the unit without observing the manufacturer's instructions may alter its safety qualification.

To ensure correct operation of the apparatus, only NTC type probes supplied by AKO should be used.

Between -40 °C and +20 °C, when the NTC probe is extended up to 1.000 m with minimum 0,5 mm2 cable, deviation will be less than 0.25 °C (Probe extension cable ref. **AKO-15586**)

10- Operation and control of relays R1 and R2

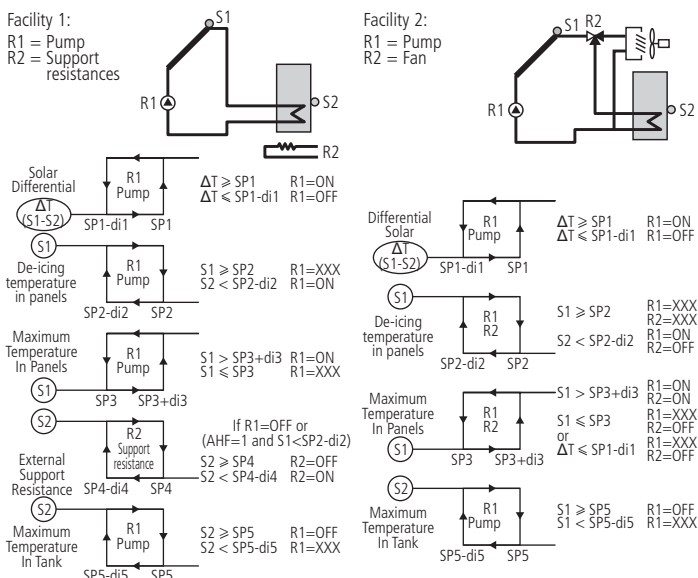

If E1 (Sensor 1 Failure) R1 = ON, R2 = OFF
If E2 (Sensor 2 Failure) R1 = XXX, R2 = OFF