

SSR 02-102-192-05-H-AC2-DP2-0.5-J12

Measuring Light Curtains

Measuring Light Curtains

Compatible Transmitter:

SST 02-102-192-05-H-1D1-0.5-J5



Product Data	
Channel Spacing	5 mm
Function	Receiver
Operation Mode	Thru Beam
Supply Voltage	18 - 30 V dc
Connection	0.5 m cable with 12 pin, M12 plug
Sensing Range	10 m
Output	2 x PNP + Analog. (RS-485)
Output Status	N.C. / N.O.
Length	1020 mm
Active Height	960 mm
Housing	33 x 36 mm
Features	RS-485 communication port

Technical Data	
Supply Voltage	18 - 30 V dc
Reverse Polarity Protected	Yes
Short Circuit Protected	Yes
Current Consumption	75 mA
Output Type	2 x Digital Output (Transistor) PNP Analogue Out. 4-20 mA / 0-10 V (2-wires)
Output Rating	Digital Output: 100 mA Analogue Output: Current <600 Ohm - Voltage >1kOhm
Number of Channels	192
Number of Cross Scanning Beams	574
Number of Parallel Beams	192
Distance, Beams Pinch Point	2,5 mm
Channel Spacing	5 mm
Response Time	Beams: Parallel 25,0 ms / Cross 70,9 ms
Power On Indicator	Green LED
Output Indicator	Yellow LED

System Status Indicator	Red LED
Profile Dimensions (w x d)	33 x 36 mm
Housing Material, Front Lens	Polycarbonate
Housing Material, Profile	Aluminium (black anodised)
Cable	12 x 0,2 mm ²
Cable Sleeve	PVC Ø 5,9 mm

Environmental Data	
Vibration	10 - 55 Hz, 0,5 mm
Shock	30 g
Operation Temperature	-30 to +60 °C
Storage Temperature	-40 to +80 °C
Sealing Class	IP 67
Light Immunity 5*	> 100 000 lux

Approvals

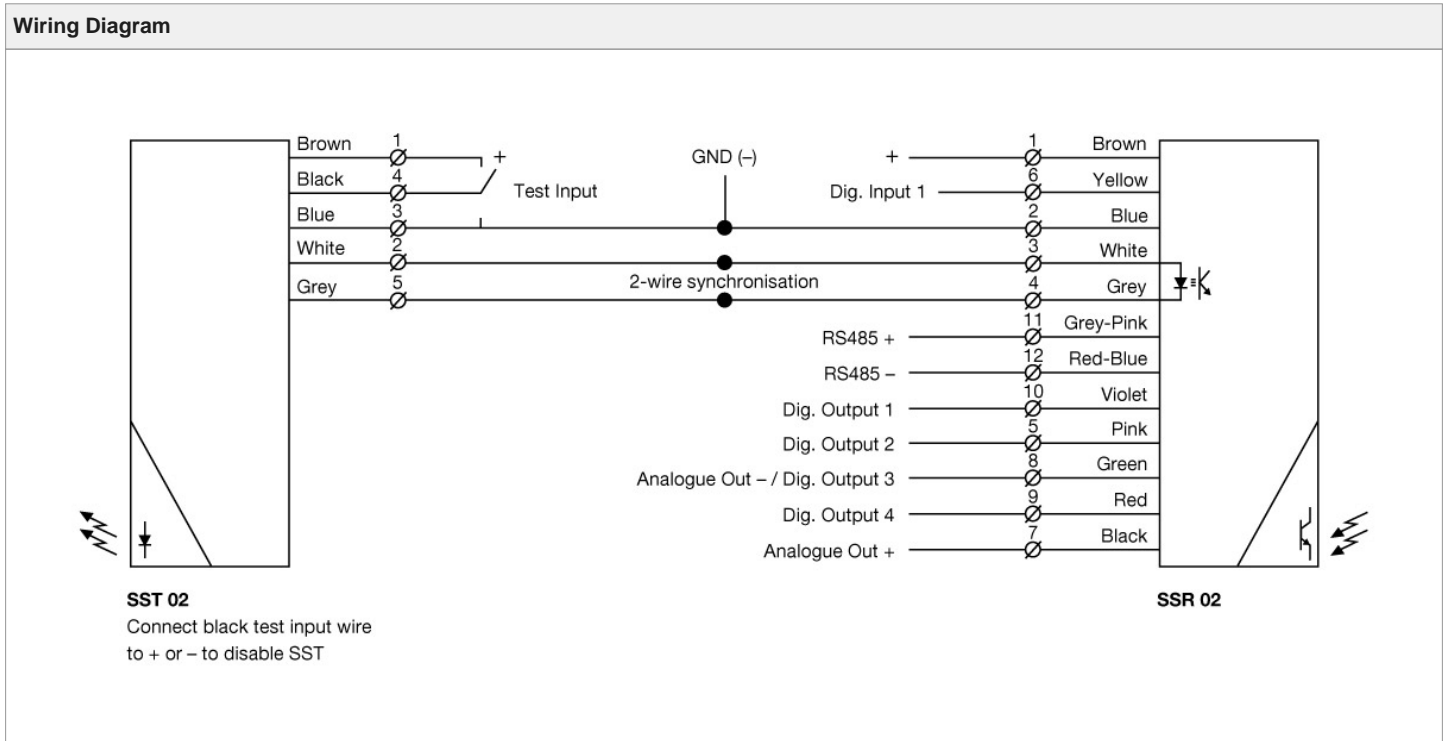



Connections

12 pin, M12

Sensor Plug
(Male)

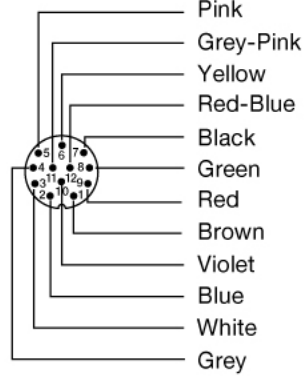
Cable Plug
(Female)



Parallel Displacement

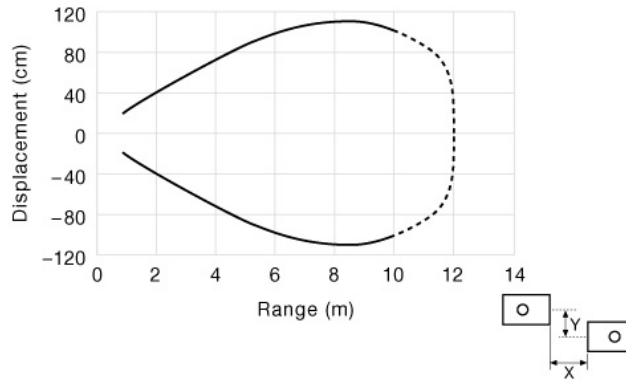

Beam Patterns

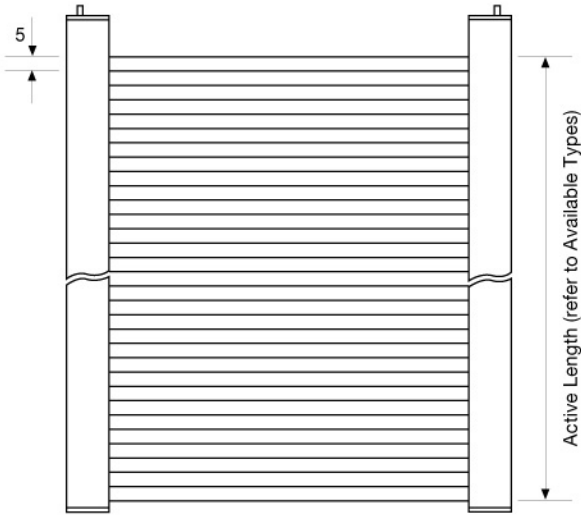

Parallel Beams

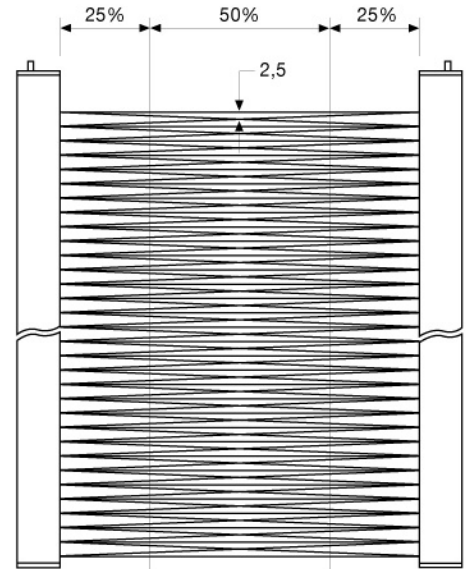

Cross Beams

5 mm channel spacing

Dimensions

