



ER System

The pioneering toolholding system

Product catalog

REGO-FIX 

Providing solutions for cutting-edge toolholding

Three systems – one brand	4	Special solutions: ER secuRgrip®	12
Wet and dry machining	6	Special solutions: Hi-Q® / ERMX intRlox®	14
Special solutions: reCool® RCS / RCR	8	Special solutions: XL colletholders	15

1.0 ER colletholders

Minimize runout – boost productivity 19

1.1 Standard spindle toolholders

1.1.1 CAT	20
1.1.2 SK	26
1.1.3 BT	32
1.1.4 HSK	42
1.1.5 REGO-FIX CAPTO <small>licensed by Sandvik Coromant</small>	48
1.1.6 Cylindrical (CYL)	52
1.1.7 MK	64
1.1.8 SH	66
1.1.9 ISO 20	68

1.2 ER tapping holders HSK-A SSY, CYL SSY, CYL GSF	70
1.3 ER floating chucks PH, PHC, PHC-C, MPH	72
1.4 Collet reductions ER / ERM, ERM / ERM, ER / ERMX, ERMX / ERMX	78

2.0 ER collets

Successful clamping since 1972 83

2.1 Collets

2.1.1 Microbore ER-MB	86
2.1.2 ER standard and ultraprecision ER-UP	87
2.1.3 Metallic sealed ER-DM	96
2.1.4 secuRgrip® ER-SG	101

2.2 ER tapping collets

2.2.1 ER-GB	102
2.2.2 PCM ET1	106

3.0 ER clamping nuts, reCool® and disks

Innovative products fitting your needs 111

3.1 Clamping nuts

3.1.1 Hi-Q® ER / ERC standard	114
3.1.2 Hi-Q® ERB / ERBC	118
3.1.3 Hi-Q® ERM / ERMX	120
3.1.4 Hi-Q® ERMX / ERMX intRlox®	122
3.1.5 ER MS	124
3.1.6 Hi-Q® ERAX / ERAXC	126

3.2 reCool® coolant supply system

3.2.1 reCool® rotary RCR	128
3.2.2 reCool® static RCS	130
3.2.3 reCool® accessories	132











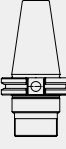
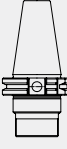

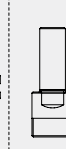

3.3 Disks

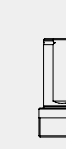
3.3.1 Sealing disks DS / ER	134
3.3.2 Coolant flush disks KS / ER	142

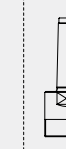

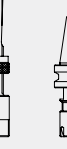
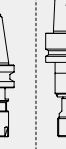
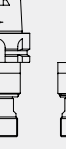



4.0 ER accessories 148

5.0 Technical information 158















Experience the widest ER range

Standard					Cylindrical collets				Colletholders for tapping			Floating chucks		Collet reductions		
CAT/ER	SK/ER	BT/ER	HSK/ER	REGO-FIX CAPTO/ER licensed by Sandvik Coromant	CYL/ER	CYL/ERM(X) CYLF/ERM(X)	CYL/ER NC	CYDF/ERM CYDF/ERM(X)	MK/ER	SH/ER	ISO 20/ER	HSK-A SSY	CYL SSY CYL GSF	PH/ER PHC/ER PHC-C/ER	MPH/ERM(X)	ER(M)/ERM ER(MX)/ERM(X)
																
page 22	page 28	page 34	page 44	page 50	page 54	page 58	page 63	page 64	page 66	page 68	page 70	page 72	page 72	page 74	page 78	page 80

1.0 ER collets

Micro-machining	Standard and ultraprecision	Metallic sealed	Pullout protection secuRgrip®	Collets for tapping	
ER-MB	ER standard/ ER-UP	ER-DM	ER-SG	ER-GB	PCM ET1
					
page 88	page 89	page 98	page 103	page 104	page 108

2.0 ER collets

Standard		Standard with bearing		Mini nut		Slip-off proof mini nut		External thread			Sealing and cooling disks		
Hi-Q®/ER	Hi-Q®/ERC	Hi-Q®/ERB	Hi-Q®/ERBC	Hi-Q®/ERM	Hi-Q®/ERMC	Hi-Q®/ERM(X) intRlox®	Hi-Q®/ERM(X) intRlox®	ER MS	Hi-Q®/ERAX	Hi-Q®/ERAXC	reCool® RCR/RCS	DS/ER	KS/ER
													
page 114	page 116	page 118	page 118	page 120	page 120	page 122	page 122	page 124	page 126	page 126	page 128	page 134	page 142

B: bearing C: cooling M: mini thread X: slip-off proof

DS: sealing disk KS: coolant flush disk

3.0 ER clamping nuts, reCool®, disks

For torque wrenches and other accessories please refer to page 148.

Suitable for carbide or HSS milling cutter in all shank forms (Weldon, Whistle-Notch, etc.)



At a glance

Providing solutions for cutting-edge toolholding

Our holistic toolholding systems excel with extraordinary reliability, high precision and outstanding quality.

Pioneering spirit Fritz Weber, a Swiss master craftsman, tapped into the promising optimism in the 1950s and founded a small business called Fritz Weber Feinmechanik und Werkzeugbau. With his innovative spirit and stern determination, Fritz Weber gradually expanded his range of products. The company, now called REGO-FIX AG, achieved international recognition in 1972 with the invention of the ER clamping system. Thus, changing the toolholding industry forever. The ER System, made in Switzerland, is an industrial standard clamping element. It set the industry standard and even became DIN Standard (DIN 6499) in 1993. Today, the ER collet made by REGO-FIX is still the most used clamping collet worldwide.

Shaping the future REGO-FIX is an international family-owned company that is run by the sons of Fritz Weber. With its over 220 employees, REGO-FIX manufactures and markets high-precision toolholding systems worldwide. Headquartered in Tenniken, Switzerland, the company has established itself

as one of the leading manufacturers of toolholding systems and enjoys an excellent industry-wide reputation. Through its close network of distributors and subsidiaries in the US and China, REGO-FIX is strategically well positioned and possesses a worldwide presence in key markets. With groundbreaking product inventions, REGO-FIX developed from a small company to a global solution provider for cutting-edge toolholding systems. At the core of every product lies an aim for machining excellence and a passion for precision.

Cradle of precision REGO-FIX manufactures its products in Switzerland to fit highest quality standards. The products are used in the fields of automotive, aerospace, medical engineering, watchmaking, telecommunications and also in the die and mold industry.



ER System

Defining toolholding standards

When REGO-FIX first introduced the ER System in 1972, it took the machining world by storm. With the DIN 6499 standardization twenty years later, the REGO-FIX ER collet became the industry standard. Today, the ER System is still the most used toolholding system worldwide.

Key advantages

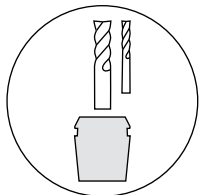

The widest ER product range: clamps all diameters from 0.2 mm – 36 mm.

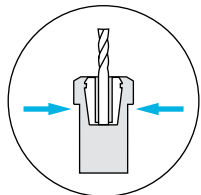

Safe and accurate toolholding of all shank types and materials.

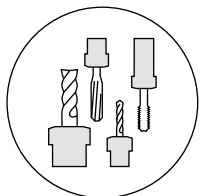

Outstanding flexibility for use with all tool types.

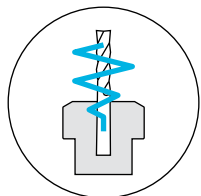

High vibration-dampening results in longer tool life and best surface finish.

High quality matters An outstanding tool runout is one of the most positive influences on enhancing your tool life.

Extend tool life with the REGO-FIX ER range

Influence of tool runout on tool life / Source: In-house testing

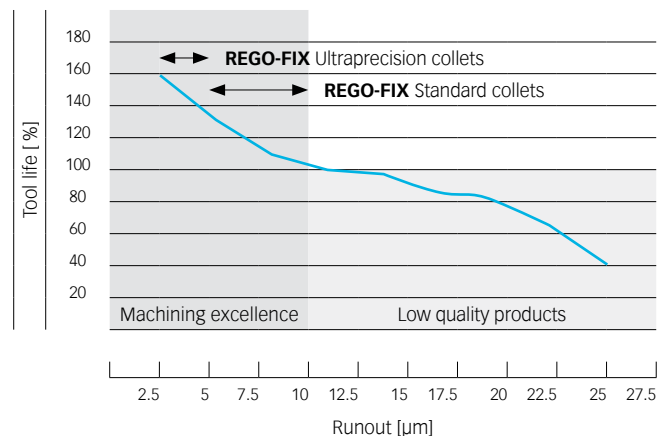

Three systems – one brand

Our brand unites three different toolholding systems. Each system has different strengths to fit your machining needs, but at the heart of each system lies our aim for toolholding excellence.

powRgrip® System

For high-end machining with a total system **TIR ≤ 0.0001" (3 µm) at 3xD**

PG colletholders

Taper accuracy AT3

Surface finish
max. Ra 0.25

High transferable torque
up to 1,100 Nm

PG collets

Clamping range
from 0.0079" up to 1"

Highly durable coating
ensures longevity

Clamps all shanks
with tolerance h6

Vibration-dampening
for high RPM

A holistic system approach

All parts are designed for exclusive fit to ensure toolholding excellence.

ER System

Our ideal system for standard machining

ER colletholders

Runout TIR ≤ 0.0001" (3 µm)

Taper accuracy AT3

Surface finish max. Ra 0.25

Factory balanced

ER collets

Wide clamping range: from ER 8 up to ER 50 and
for diameters from 0.0079" up to 1.375"

Clamping capacity 0.0197" to 0.0787"

Runout TIR ≤ 0.0004" (10 µm) at 3xD for ER standard

Runout TIR ≤ 0.0002" (5 µm) at 3xD for ER-UP

ER clamping nuts

Collet-locking system

Balanced by design

Special coating improves transferable torque
and protects against corrosion



micRun® System

Total system **TIR ≤ 0.0001" (3 μm) at 3xD**

MR colletholders

Taper accuracy AT3

Polished surface for improved performance

Balanced for high RPM

Vibration dampening

MR collets

Clamping range from 0.0394" to 0.7874"

Nominal diameter shanks h11

MR clamping nuts

Collet-locking system

Balanced by design

Groove-less design for higher RPM

Freewheel wrench head

A holistic system approach

All parts are designed for exclusive fit to ensure toolholding excellence.

Master both wet and dry applications

We offer efficient solutions for specific machining techniques and different work materials to maximize your machining.

Dry machining



Dry machining is mainly used for specific machining techniques and work materials, such as carbon, high-tensile plastics or wood.

Pros

- // Reduced initial machine investment costs
- // Simple and easy cleaning
- // Clear sight on point of action between tool and workpiece

Cons

- // Inadequate heat dissipation can lead to a reduced tool life
- // Increased tooling costs due to earlier wear and tear
- // Extended production cycles due to slower possible production speed

Wet machining



The cutting edge is subject to thermal strains. Wet machining thus helps to regulate the impact of high heat that occurs during milling, ultimately protecting the tool against total tool failure.

Pros

- // Fast and effective heat dissipation
- // Improved surfaces thanks to lubrication of cutting edge
- // Clean and easy chip removal
- // Production cycles can be increased leading to an overall increase of productivity
- // Lowered tool costs

Cons

- // Additional costs for the acquisition of a pump
- // Limited view on point of action
- // Wet surroundings may present as an ideal bacteria breeding ground

Supplying the right amount of coolant to where it matters



Key features of external flood cooling

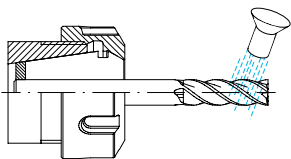

- // Flood coolant may be difficult to direct straight to the cutting edge
- // Flood cooling uses more coolant than really necessary
- // Universal application possibilities
- // Problems may arise with deep cavities
- // Reduction of tool life because cooling is not right on the cutting edge
- // Suboptimal chip deflection
- // Limited adjustment of nozzles due to different tool lengths and diameters

Key features of peripheral cooling

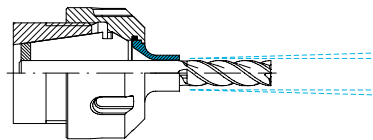

- // Coolant flush disk is inserted into ERC clamping nut
- // Coolant is fed along the side of the tool to the cutting edge
- // Can be used for moderate cavities

Key features of internal cooling

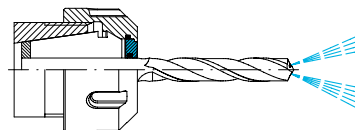

- // Sealing disk is inserted into ERC clamping nut
- // Precise cooling at the cutting edge and improved chip removal
- // Particularly suitable for deep cavities
- // Lubrication of cutting edge and cooling
- // Best surface quality

Efficient retrofitting to internal cooling

Retrofit flood cooling to internal cooling in two minutes with the reCool® set. Available for rotary and static tooling systems.

Key features of reCool® static RCS for use with static holders

- // Cost-friendly conversion of existing tooling systems to through coolant in only two minutes
- // For ER collets (DIN 6499 / ISO 15488) in stationary colletholders with external fine threads*
- // Coolant pressures of up to 2100 PSI**
- // RCS / ERMX for emulsion and oil coolants
- // Low-maintenance design
- // For coolant through tools (with sealing disks DS) and for peripheral cooling (with coolant flush disks KS)

* reCool® static can also be used for internal threading with the corresponding adapter.

** With high-pressure hoses RHS-HP. 1400 PSI with standard hose.

Key features of reCool® rotary RCR for use with spindles

- // Cost-friendly conversion of existing tooling systems to through coolant in only two minutes
- // For ER and ERM nuts in live tools and turning machines and for ER collets to ISO 15488 / DIN 6499
- // Speeds up to 12,000 rpm*
- // Coolant pressures up to 800 PSI in RCR / ER**
- // Maintenance-free coolant lubricated bearings
- // For coolant through tools (with sealing disks DS) and for peripheral cooling (with coolant flush disks KS)
- // RCR / ER for emulsion coolants and RCR / ERM for emulsion and oil coolants
- // Convert inner-threaded live tools to outer-threaded, using the reCool® adapter. Thus, successfully prepare different types of live tooling for the use of reCool®
- // Not for use with sealed collets

* 6,000 rpm with RCR / ER 40.

** Coolant pressures up to 1400 or 2100 PSI for RCR / ERM.

We refitted a client's turning machine from conventional flood cooling to internal cooling using reCool® by REGO-FIX. We doubled their productivity and increased their quality too. **Renate Coulaudon** CEO SIFOM (France)



Get your reCool®

Go to page 128 for all reCool® rotary products or page 130 for all reCool® static products.



Refitted with reCool® static RCS/ER

reCool® customer case / standard turning machine

Conventional flood cooling

reCool® static RCS in use

Results with reCool® static

Bore Ø 0.1378", length 0.9055" (2x13 mm)	Ø 0.1378", length 0.9055" (1x23 mm)	Only drilling from one side
Spindle speed 5,000 rpm	7,500 rpm	150% increase
Feed 180 ft / min	270 ft / min	150% increase
Depth 5xD (both sides)	8xD (from one side)	50% increase
Drill operations 2 per side	Single drilling	Three drilling operations less with reCool®
Runout TIR of bore 0.0016" – 0.0020"	0.0004" – 0.0008"	Improved by 0.0008"
Coolant pressure –	400 PSI	Inner cooling achieved
Working time per piece 8.6 s	2.0 s	Time reduced by 6 seconds
Tool life 8,000 pieces	20,000 pieces	250% increase in tool life

**Customers from all around the world
rely on Swiss-made REGO-FIX products.
From Tenniken, we deliver to customers
in fast-paced industries with the highest
demands for precision.**

We offer competitive solutions





Form-fit for 100% pullout protection

With our innovative secuRgrip® solution, we offer a total pullout protection for the ER System.



Threaded insert for end mill flat

Key advantages

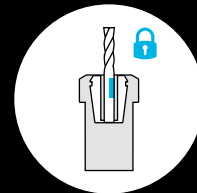

ER secuRgrip® is available for all standard tools with Weldon flat (12 – 25 mm), without additional modifications.

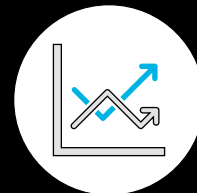

Increase productivity through process reliability.

Fitted to REGO-FIX ER standards:

Use your existing REGO-FIX ER collets and ER nuts.

Safe machining even for difficult to handle workpieces

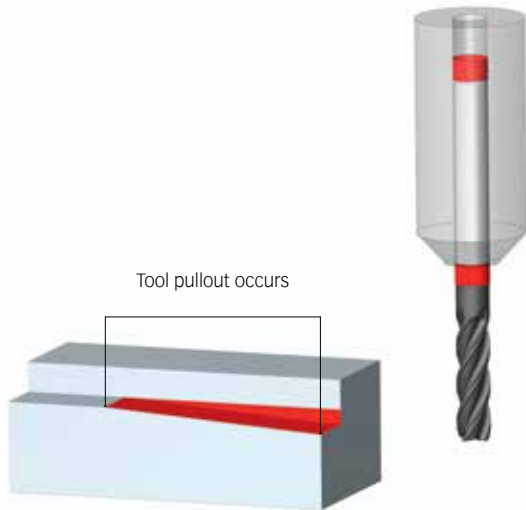

Length alterations can lead to damage of the workpiece.

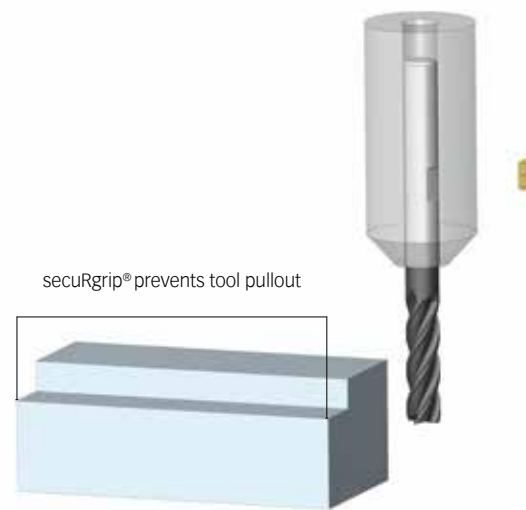

Prevent workpiece damage by using REGO-FIX secuRgrip®.

Full protection where you need it The secuRgrip® threaded insert is designed to fit in any tool with a Weldon flat. This way you can use the tool of your choice. In combination with our ER secuRgrip® collet, we offer the ultimate tool pullout protection at a competitive price. Avoiding length alterations caused by tool pullout results in improved process reliability and ultimately improves your overall machining productivity. Our secuRgrip® solution is available for ER 32 and ER 40 – just the right sizes when it comes to rough-machining.

- // No additional costs for replacing damaged tools, thanks to ER secuRgrip®
- // No modification of the tool shank is required
- // Extra protection for worry-free machining, especially with expensive work pieces

[Get your ER secuRgrip®](#)

Go to page 101 for all ER secuRgrip® product part numbers.

Prevent work injuries caused by slip-offs

The Hi-Q® / ERMX intRlox® and Hi-Q® / ERMXC intRlox® mini clamping nuts have a specially designed profile to fit the wrench. This special profile prevents from slipping-off when tightening or loosening the nut.

Key features of Hi-Q® / ERMX intRlox®

- // Slip-off proof with self-locking profile
- // Special surface treatment for higher clamping force
- // Corrosion-resistant surface
- // Hi-Q® / ERMXC intRlox® suitable for our sealing disks (DS / ER) and coolant flush disks (KS / ER), suited for coolant pressures up to 2100 PSI
- // For ER collets in accordance with DIN 6499 / ISO 15488 (REGO-FIX ER standard and ER-UP), with microbore (ER-MB), metallic-sealed type collets (ER-DM), tapping collets (ER-GB and PCM ET1)
- // Suitable for mini nut thread pitch colletholders with fine thread
- // Square-socket drive on V-E MX extension available

Benefits

- // Safe handling with slip-off proof design thanks to the patented intRlox® profile
- // Slip-off proof design with all advantages of the regular mini clamping nuts
- // Easy and safe clamping with MX wrench and wrench head extensions for applications with little room for wrenches
- // Design is ideally suited for lathes and Swiss turning machines
- // Matching accessories available: wrench and extension combinations prevent slipping-off when changing tools in the machine
- // Very slim sizing proofs suitable for machines where space is limited

[Get your Hi-Q® / ERMX intRlox®](#)

Go to page 122 for all Hi-Q® / ERMX intRlox® products. Slip-off proof extensions V-E MX are on page 152.



XL vibration dampening

Optimize your surface finishes and extend tool life by minimizing vibrations during machining.

Minimize tool vibrations The MICRO-FRICTION DAMPENING™ (MFD) technology (pat. pend.) by REGO-FIX allows our XL colletholders to dissipate vibrations faster than standard long-reach colletholders. Dampening the vibrations faster means that your cutting tool, part and spindle will see less vibrations resulting in better surface finishes, longer tool life and less spindle wear. All REGO-FIX XL colletholders are designed for use of max 5,000 rpm.

Key advantages

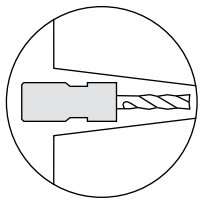

Minimal outside dimensions: long and slim design.

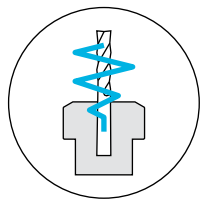

Exclusive vibration-dampening design.

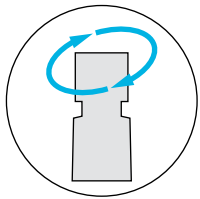

Balanced by design.

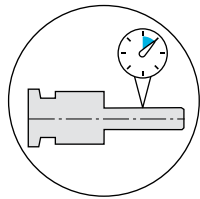

TIR I.D. to O.D. $\le 10 \mu\text{m}$.



Vibration chart for the ER System

Decay of REGO-FIX XL colletholder with vibration-dampening design
Source: In-house testing

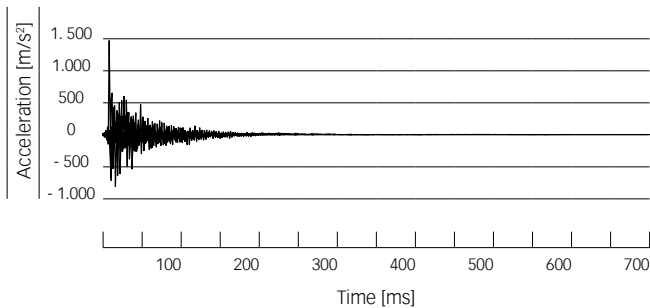

Vibration chart for the ER System

Monoblock standard colletholder without vibration-dampening design
Source: In-house testing

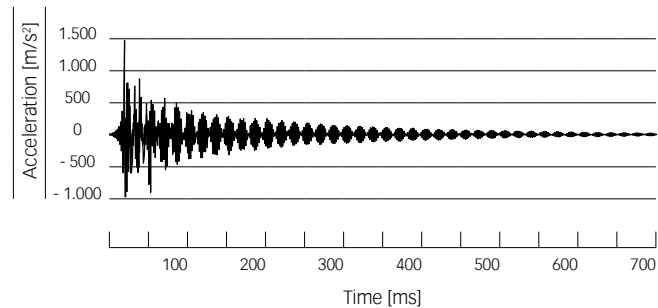





We engineer and manufacture our products at our headquarters. From Tenniken, we deliver our innovative Swiss-made toolholding systems worldwide.

True Swiss quality

Standard					Cylindrical collets					Collet holders for tapping		Floating chucks		Collet reductions		
CAT/ER	SK/ER	BT/ER	HSK/ER	REGO-FIX CAPTO/ER licensed by Sandvik Coromant	CYL/ER	CYL/ERM(X) CYLF/ERM(X)	CYL/ER NC	CYDF/ERM CYDF/ERM(X)	MK/ER	SH/ER	ISO 20/ER	HSK-A SSY	CYL SSY CYL GSF	PH/ER PHC/ER PHC-C/ER	MPH/ERM(X)	ER(M)/ERM ER(MX)/ERM(X)
page 22	page 28	page 34	page 44	page 50	page 54	page 58	page 63	page 54	page 66	page 68	page 70	page 73	page 73	page 74	page 78	page 80



Minimize runout – boost productivity

Experience outstanding quality We at REGO-FIX know how to minimize your runout and boost your productivity. This is why we designed our ER colletholders to fulfill diverse criteria all crucial for achieving machining excellence.

The outstanding design paired with our experienced engineering make the ER products some of our most successful toolholding options. REGO-FIX ER collets exceed the DIN requirements with a collet TIR of 5 µm or better. Further increases in machining productivity are possible by incorporating our matching items.

The ER colletholder, collet and Hi-Q® nut together make the ER System a solid option for traditional machining applications. What you see is what you get: all our products bear the REGO-FIX triangle – our seal for outstanding Swiss quality.



Swiss quality standard

Our products marked Swiss made are manufactured at our headquarters in Tenniken, Switzerland.

Steep taper colletholders CAT

Universally suitable for different machining applications.

DIN 69871 / DIN ISO 7388-1

Features and benefits

Runout TIR $\leq 0.0001''$ (3 μ m)

Measured from inner taper to outer taper.

Taper accuracy AT3

Better spindle-to-holder fit and accuracy.

Surface finish max. Ra 0.25

Achieve high clamping force and high transferable torque.

Balancing

100 % balanced to G 2.5 @ 22,000 rpm.

Balancing in XL colletholders

100 % balanced to G 2.5 @ 5,000 rpm.

Hi-Q® balancing system

Ready to accept Hi-Q® balancing rings which allow for the offset of the imbalance introduced by the cutting tool up to 80,000 rpm depending on the balancing rings used. All colletholders with the additional type information "H" in the article name are designed for balancing rings.

Hi-Q® / ER clamping nut included in delivery

Guarantees highest clamping force and best balancing.

Vibration dampening

Our holders offer good vibration dampening to sustain a high surface finish and can help prevent chatter.



Information



CAT / ER and CAT / ER XL colletholders

Applications

These colletholders are designed for CNC-machining centers with an automatic tool changer. They are universally suitable for different machining applications. Their vibration dampening reduces spindle wear and extends tool life.

Balancing

REGO-FIX CAT/ER colletholders are balanced to G 2.5 @ 22,000 rpm. Type H colletholders are ready to accept Hi-Q® balancing rings. This allows precision-balancing of the system including cutting tool up to 80,000 rpm depending on the balancing rings used.

CAT / ER XL available

Due to their good vibration-dampening installation, CAT / ER XL holders are ideally suited in all machining processes where the standard length colletholders cannot be used.

For more details on our XL colletholders, please refer to page 15.

Special applications

When extra high clamping force is needed, e.g., when tapping with ER-GB, we recommend using our friction-bearing clamping nuts Hi-Q® / ERB and Hi-Q® / ERBC.

Matched tooling system for best fit

For highest precision and best results the entire machining system counts. Therefore REGO-FIX components are carefully matched for optimum fit and accuracy. This guarantees the best runout and balance.

For the influence of runout on tool life, please refer to page 3.

Information



CAT / ERA colletholders

Applications

These colletholders are specially designed for mill-turning machines, multitasking machines and small vertical machining centers. They have the well-known REGO-FIX surface finish and are manufactured to meet our high-precision standards. ERA colletholders possess superior rigidity due to the shortness of the holder. ERA Zero-Z® colletholders have the shortest possible projection to increase the Z axis travel of the machine and to allow larger workpieces to be machined.

Features

REGO-FIX CAT / ERA colletholders are balanced to G 2.5 @ 22,000 rpm. The Hi-Q® / ERAX clamping nut has been specially designed for applications where space is scarce.

For the influence of runout on tool life, please refer to the graph on page 3.

Expert advice

We recommend tightening the clamping nuts using a torque wrench.

For tightening torque recommendations, please refer to page 163.

CAT colletholders

ERA Zero-Z[®] colletholder

CAT

Type	Part no.	Dimensions				Accessories	
		D [mm]	D1 [mm]	L [inch]	L1 [inch]	FWR ...*	Wrench
CAT 30							
CAT 30 / ER 16 x 4"	2330.11651	28	–	4	–	–	7112.16010
CAT 30 / ER 20 x 3" H	4330.12031	34	–	3	–	285	7112.20010
CAT 30 / ER 25 x 60 mm	2330.12520	42	–	60 mm	–	–	7111.25000
CAT 30 / ER 32 x 3"	2330.13231	50	–	3	–	–	7111.32000
CAT 40							
CAT 40 / ER 11 x 3" H	4340.11131	19	–	3	–	325	7112.11010
CAT 40 / ER 11 x 6" H	4340.11171	19	–	6	–	325	7112.11010
CAT 40 / ER 16 x 3" H	4340.11631	28	–	3	–	325	7112.16010
CAT 40 / ER 16 x 4" H	4340.11651	28	–	4	–	285	7112.16010
CAT 40 / ER 16 x 6" H	4340.11671	28	–	6	–	325/225	7112.16010
CAT 40 / ER 16 x 8" XL	8843.13031	28	42	8	4	–	7112.16010
CAT 40 / ER 16 x 10" XL	8843.13101	28	42	10	4	–	7112.16010
CAT 40 / ER 16 x 12" XL	8843.13131	28	42	12	8	–	7112.16010
CAT 40 / ER 16 x 14" XL	8843.13181	28	42	14	8	–	7112.16010
CAT 40 / ER 20 x 3" H	4340.12031	34	–	3	–	285	7112.20010
CAT 40 / ER 20 x 4" H	4340.12051	34	–	4	–	325	7112.20010
CAT 40 / ER 20 x 6" H	4340.12071	34	–	6	–	405/285	7112.20010
CAT 40 / ER 25 x 4" H	4340.12551	42	–	4	–	325	7111.25000
CAT 40 / ER 25 x 6" H	4340.12571	42	–	6	–	405/325	7111.25000
CAT 40 / ERA 32 x 019 mm	2340.13200	35	–	19 mm	–	–	7117.32000
CAT 40 / ER 32 x 3" H	4340.13231	50	–	3	–	405	7111.32000
CAT 40 / ER 32 x 4" H	4340.13251	50	–	4	–	405	7111.32000
CAT 40 / ER 32 x 5" H	4340.13261	50	–	5	–	405	7111.32000
CAT 40 / ER 32 x 6" H	4340.13271	50	–	6	–	405/405	7111.32000
CAT 40 / ER 32 x 10" XL	8843.16081	50	52	10	4	–	7111.32000
CAT 40 / ER 32 x 14" XL	8843.16141	50	52	14	8	–	7111.32000
CAT 40 / ER 40 x 3.5" H	4340.14041	63	–	3.5	–	505	7111.40000
CAT 40 / ER 40 x 6" H	4340.14071	63	–	6	–	505/505	7111.40000

* Balancing rings

Included in delivery: ER colletholders come with Hi-Q[®] / ER clamping nut. ERA colletholders come with Hi-Q[®] / ERAX clamping nuts.

H: Ready to accept balancing rings

Accessories are not included in delivery. Other XL sizes available on request.

XL: For more information on XL holders see page 15.

Expert advice

What is the difference between form A+AD and AD+B?
 Form A+AD: coolant supply through the taper
 Form AD+B: coolant supply through the flange

Type	Part no.	Dimensions [mm]				Accessories	
		D	D1	L	L1	FWR ...*	Wrench
CAT-B 40							
CAT-B 40 / ER 11 x 3" H	4340.11134	19	–	3	–	325	7112.11010
CAT-B 40 / ER 11 x 6" H	4340.11174	19	–	6	–	325	7112.11010
CAT-B 40 / ER 16 x 3" H	4340.11634	28	–	3	–	325	7112.16010
CAT-B 40 / ER 16 x 4" H	4340.11654	28	–	4	–	285	7112.16010
CAT-B 40 / ER 16 x 6" H	4340.11674	28	–	6	–	325/225	7112.16010
CAT-B 40 / ER 20 x 3" H	4340.12034	34	–	3	–	285	7112.20010
CAT-B 40 / ER 20 x 4" H	4340.12054	34	–	4	–	325	7112.20010
CAT-B 40 / ER 20 x 6" H	4340.12074	34	–	6	–	405/285	7112.20010
CAT-B 40 / ER 25 x 4" H	4340.12554	42	–	4	–	325	7111.25000
CAT-B 40 / ER 25 x 6" H	4340.12574	42	–	6	–	405/325	7111.25000
CAT-B 40 / ER 32 x 3" H	4340.13234	50	–	3	–	405	7111.32000
CAT-B 40 / ER 32 x 4" H	4340.13254	50	–	4	–	405	7111.32000
CAT-B 40 / ER 32 x 5" H	4340.13264	50	–	5	–	405	7111.32000
CAT-B 40 / ER 32 x 6" H	4340.13274	50	–	6	–	405/405	7111.32000
CAT-B 40 / ER 40 x 3.5" H	4340.14044	63	–	3.5	–	505	7111.40000
CAT-B 40 / ER 40 x 6" H	4340.14074	63	–	6	–	505/505	7111.40000

* Balancing rings

Included in delivery: ER colletholders come with Hi-Q® / ER clamping nut. ERA colletholders come with Hi-Q® / ERAX clamping nuts.

H: Ready to accept balancing rings

Accessories are not included in delivery.

XL: For more information on XL holders see page 15.

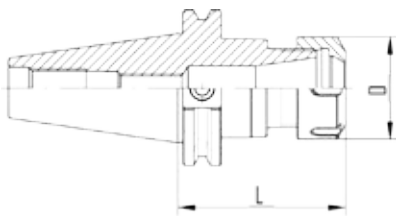

CAT / ER (Form A+AD)

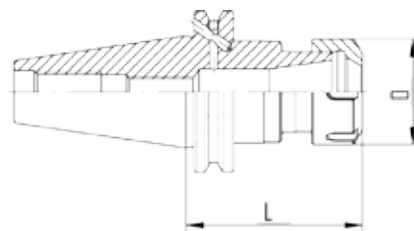

CAT-B / ER (Form AD+B)

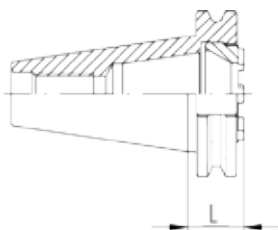

CAT / ERA

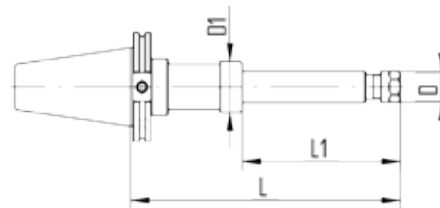

CAT / ER XL (Form A+AD)

CAT colletholders

CAT-B colletholders

CAT

CAT-B

Type	Part no.	Dimensions				Accessories	
		D [mm]	D1 [mm]	L [inch]	L1 [inch]	FWR ...*	Wrench
CAT 50							
CAT 50 / ER 16 x 4" H	4350.11651	28		4		505	7112.16010
CAT 50 / ER 16 x 6" H	4350.11671	28		6		505/225	7112.16010
CAT 50 / ER 16 x 8" XL	8853.13031	28	42	8	4		7112.16010
CAT 50 / ER 16 x 10" XL	8853.13081	28	42	10	4		7112.16010
CAT 50 / ER 16 x 12" XL	8853.13131	28	42	12	8		7112.16010
CAT 50 / ER 16 x 14" XL	8853.13181	28	42	14	8		7112.16010
CAT 50 / ER 20 x 4" H	4350.12051	34		4		505	7112.20010
CAT 50 / ER 20 x 6" H	4350.12071	34		6		505/285	7112.20010
CAT 50 / ER 25 x 4" H	4350.12551	42		4		505	7111.25000
CAT 50 / ER 25 x 6" H	4350.12571	42		6		505/325	7111.25000
CAT 50 / ER 32 x 4" H	4350.13251	50		4		505	7111.32000
CAT 50 / ER 32 x 6" H	4350.13271	50		6		505/405	7111.32000
CAT 50 / ER 32 x 10" XL	8853.16081	50	52	10	4		7111.32000
CAT 50 / ER 32 x 14" XL	8853.16181	50	52	14	8		7111.32000
CAT 50 / ERA 40 x 019 mm	2350.14007	44		19 mm			7117.40000
CAT 50 / ER 40 x 4" H	4350.14051	63		4		505	7111.40000
CAT 50 / ER 40 x 6" H	4350.14071	63		6		505/505	7111.40000

CAT-B 50							
CAT-B 50 / ER 16 x 4" H	4350.11654	28		4		505	7112.16010
CAT-B 50 / ER 16 x 6" H	4350.11674	28		6		505/225	7112.16010
CAT-B 50 / ER 20 x 4" H	4350.12054	34		4		505	7112.20010
CAT-B 50 / ER 20 x 6" H	4350.12074	34		6		505/285	7112.20010
CAT-B 50 / ER 25 x 4" H	4350.12554	42		4		505	7111.25000
CAT-B 50 / ER 25 x 6" H	4350.12574	42		6		505/325	7111.25000
CAT-B 50 / ER 32 x 4" H	4350.13254	50		4		505	7111.32000
CAT-B 50 / ER 32 x 6" H	4350.13274	50		6		505/405	7111.32000
CAT-B 50 / ER 40 x 4" H	4350.14054	63		4		505	7111.40000
CAT-B 50 / ER 40 x 6" H	4350.14074	63		6		505/505	7111.40000

* Balancing rings

Included in delivery: ER colletholders come with Hi-Q® / ER clamping nut. ERA colletholders come with Hi-Q® / ERAX clamping nuts.

H: Ready to accept balancing rings

Accessories are not included in delivery. Other XL sizes available on request.

XL: For more information on XL holders see page 15.

Expert advice

For additional technical drawings and details, see the REGO-FIX website at www.rego-fix.com

CAT+ REGO PLUS dual contact colletholders

Certified The BIG PLUS SYSTEM – licensed by BIG Daishowa – is manufactured at REGO-FIX in Switzerland under license according to BIG PLUS specifications.

Key advantages

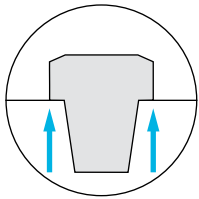

Higher colletholder stiffness due to taper (AT1) and face contact

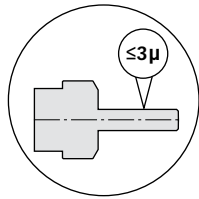

Improved machining accuracy and better surface finish

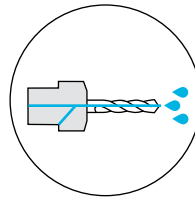

Form AD+B as standard configuration

Type	Part no. AD+B	Dimensions				Accessories	
		D [mm]	D1	L [inch]	L1	FWR ...*	Wrench
CAT+ 40							
CAT+ 40 / ER 11 x 3" H	4340.11136	19	–	3	–	285	7112.11010
CAT+ 40 / ER 16 x 3" H	4340.11636	28	–	3	–	325	7112.16010
CAT+ 40 / ER 16 x 6" H	4340.11676	28	–	6	–	325/225	7112.16010
CAT+ 40 / ER 20 x 3" H	4340.12036	34	–	3	–	285	7112.20010
CAT+ 40 / ER 20 x 6" H	4340.12076	34	–	6	–	405/285	7112.20010
CAT+ 40 / ER 25 x 4" H	4340.12556	42	–	4	–	325	7111.25000
CAT+ 40 / ER 25 x 6" H	4340.12576	42	–	6	–	405/325	7111.25000
CAT+ 40 / ER 32 x 3" H	4340.13236	50	–	3	–	405	7111.32000
CAT+ 40 / ER 32 x 6" H	4340.13276	50	–	6	–	405/405	7111.32000
CAT+ 50							
CAT+ 50 / ER 16 x 4" H	4350.11656	28	–	4	–	505	7112.16010
CAT+ 50 / ER 16 x 6" H	4350.11676	28	–	6	–	505/225	7112.16010
CAT+ 50 / ER 20 x 4" H	4350.12056	34	–	4	–	505	7112.20010
CAT+ 50 / ER 25 x 4" H	4350.12556	42	–	4	–	505	7111.25000
CAT+ 50 / ER 32 x 4" H	4350.13256	50	–	4	–	505	7111.32000
CAT+ 50 / ER 32 x 6" H	4350.13276	50	–	6	–	505/405	7111.32000
CAT+ 50 / ER 40 x 4" H	4350.14056	63	–	4	–	505	7111.40000

* Balancing rings

H: Ready to accept balancing rings

XL: For more information on XL holders see page 15.

Included in delivery: Colletholders come with Hi-Q® / ER clamping nut.

Accessories are not included in delivery.

Steep taper colletholders SK

Universally suitable for different machining applications.

DIN 69871 / DIN ISO 7388-1

Features and benefits

Runout TIR $\leq 0.0001''$ (3 μ m)

Measured from inner taper to outer taper.

Taper accuracy AT3

Better spindle-to-holder fit and accuracy.

Surface finish max. Ra 0.25

Achieve high clamping force and high transferable torque.

Balancing

100 % balanced to G 2.5 @ 22,000 rpm.

Balancing in XL colletholders

100 % balanced to G 2.5 @ 5,000 rpm.

Hi-Q® balancing system

Ready to accept Hi-Q® balancing rings which allow for the offset of the imbalance introduced by the cutting tool up to 80,000 rpm depending on the balancing rings used. All colletholders with the additional type information "H" in the article name are designed for balancing rings.

Hi-Q® / ER clamping nut included in delivery

Guarantees highest clamping force and best balancing.

Vibration dampening

Our holders offer good vibration dampening to sustain a high surface finish and can help prevent chatter.

ID chip hole

In accordance with DIN 69873 for 10 mm diameter.



Information



SK / ER and SK / ER XL colletholders

Applications

These colletholders are designed for CNC-machining centers with an automatic tool changer. They are universally suitable for different machining applications. Their vibration dampening reduces spindle wear and extends tool life.

Balancing

REGO-FIX SK / ER colletholders are balanced to G 2.5 @ 22,000 rpm. Type H colletholders are ready to accept Hi-Q® balancing rings which allow precision-balancing of the system including cutting tool up to 80,000 rpm depending on the balancing rings used.

SK / ER XL available

Due to their good vibration-dampening installation, SK / ER XL holders are ideally suited in all machining processes where the standard length colletholders cannot be used.

For more details on our XL colletholders, please refer to page 15.

Special applications

When extra high clamping force is needed, e.g., when tapping with ER-GB, we recommend using our friction-bearing clamping nuts Hi-Q® / ERB and Hi-Q® / ERBC.

Matched tooling system for best fit

For highest precision and best results the entire machining system counts. Therefore REGO-FIX components are carefully matched for optimum fit and accuracy. This guarantees the best runout and balance.

For the influence of runout on tool life, please refer to page 3.

Expert advice

We recommend tightening the clamping nuts using a torque wrench.

For tightening torque recommendations, please refer to page 163.

Information



SK / ERA colletholders

Applications

These colletholders are specially designed for mill-turning machines, multitasking machines and small vertical machining centers. They have the well-known REGO-FIX surface finish and are manufactured to meet our high-precision standards. ERA colletholders possess superior rigidity due to the shortness of the holder. ERA Zero-Z® colletholders have the shortest possible projection to increase the Z axis travel of the machine and to allow larger workpieces to be machined.

Features

REGO-FIX SK/ERA colletholders are balanced to G 2.5 @ 22,000 rpm. The Hi-Q® / ERAX clamping nut has been specially designed for applications where space is scarce.

For the influence of runout on tool life, please refer to the graph on page 3.

SK colletholders

ERA Zero-Z® colletholder

SK
DIN 69871
DIN ISO 7388-1

Type	Part no.	Dimensions [mm]				Accessories	
		D	D1	L	L1	FWR ...*	Wrench
SK 30							
SK 30/ER 16 x 070 H	4230.11630	28	–	70	–	285	7112.16010
SK 30/ER 16 x 100 H	4230.11650	28	–	100	–	285	7112.16010
SK 30/ER 25 x 060 H	4230.12520	42	–	60	–	325	7111.25000
SK 30/ER 32 x 065	2230.13220	50	–	65	–	–	7111.32000
SK 40							
SK 40/ER 11 x 100 H	4240.11150	19	–	100	–	325	7112.11010
SK 40/ER 11 x 160 H	4240.11180	19	–	160	–	325	7112.11010
SK 40/ER 16 x 070 H	4240.11630	28	–	70	–	405	7112.16010
SK 40/ER 16 x 100 H	4240.11650	28	–	100	–	405	7112.16010
SK 40/ER 16 x 160 H	4240.11680	28	–	160	–	405 / 225	7112.16010
SK 40/ER 16 x 200 H	4240.11690	28	–	200	–	405 / 225	7112.16010
SK 40/ER 16 x 260 XL	8842.13090	28	46	260	140	–	7112.16010
SK 40/ER 16 x 300 XL	8842.13130	28	46	300	140	–	7112.16010
SK 40/ER 16 x 320 XL	8842.13150	28	46	320	240	–	7112.16010
SK 40/ER 16 x 360 XL	8842.13190	28	46	360	240	–	7112.16010
SK 40/ER 16 x 400 XL	8842.13230	28	46	400	240	–	7112.16010
SK 40/ER 20 x 070 H	4240.12030	34	–	70	–	325	7112.20010
SK 40/ER 20 x 100 H	4240.12050	34	–	100	–	325	7112.20010
SK 40/ER 25 x 070 H	4240.12530	42	–	70	–	405	7111.25000
SK 40/ER 25 x 100 H	4240.12550	42	–	100	–	405	7111.25000
SK 40/ER 25 x 160 H	4240.12580	42	–	160	–	405 / 325	7111.25000
SK 40/ER 25 x 200 H	4240.12590	42	–	200	–	405 / 325	7111.25000
SK 40/ERA 32 x 019	2240.13207	–	–	19	–	–	7117.32000
SK 40/ER 32 x 070 H	4240.13230	50	–	70	–	405	7111.32000
SK 40/ER 32 x 100 H	4240.13250	50	–	100	–	405	7111.32000
SK 40/ER 32 x 160 H	4240.13280	50	–	160	–	405 / 405	7111.32000
SK 40/ER 32 x 200 H	4240.13290	50	–	200	–	405 / 405	7111.32000
SK 40/ER 32 x 320 XL	8842.16150	50	55	320	240	–	7111.32000
SK 40/ER 40 x 080	2240.14040	63	–	80	–	–	7111.40000
SK 40/ER 40 x 100 H	4240.14050	63	–	100	–	405	7111.40000
SK 40/ER 40 x 160 H	4240.14080	63	–	160	–	505 / 505	7111.40000

* Balancing rings

Included in delivery: ER colletholders come with HI-Q®/ER clamping nut. ERA colletholders come with HI-Q®/ERAX clamping nuts.

H: Ready to accept balancing rings

Accessories are not included in delivery. Other XL sizes available on request.

XL: For more information on XL holders see page 15.

Expert advice

What is the difference between form A+AD and AD+B?
 Form A+AD: coolant supply through the taper
 Form AD+B: coolant supply through the flange

Type	Part no.	Dimensions [mm]				Accessories	
		D	D1	L	L1	FWR ...*	Wrench
SK-B 40							
SK-B 40 / ER 11 x 100 H	4240.11153	19	–	100	–	325	7112.11010
SK-B 40 / ER 11 x 160 H	4240.11183	19	–	160	–	325	7112.11010
SK-B 40 / ER 16 x 070 H	4240.11633	28	–	70	–	405	7112.16010
SK-B 40 / ER 16 x 100 H	4240.11653	28	–	100	–	405	7112.16010
SK-B 40 / ER 16 x 160 H	4240.11683	28	–	160	–	405 / 225	7112.16010
SK-B 40 / ER 16 x 200 H	4240.11693	28	–	200	–	405 / 225	7112.16010
SK-B 40 / ER 20 x 070 H	4240.12033	34	–	70	–	325	7112.20010
SK-B 40 / ER 20 x 100 H	4240.12053	34	–	100	–	325	7112.20010
SK-B 40 / ER 25 x 070 H	4240.12533	42	–	70	–	405	7111.25000
SK-B 40 / ER 25 x 100 H	4240.12553	42	–	100	–	405	7111.25000
SK-B 40 / ER 25 x 160 H	4240.12583	42	–	160	–	405 / 325	7111.25000
SK-B 40 / ER 25 x 200 H	4240.12593	42	–	200	–	405 / 325	7111.25000
SK-B 40 / ER 32 x 070 H	4240.13233	50	–	70	–	405	7111.32000
SK-B 40 / ER 32 x 100 H	4240.13253	50	–	100	–	405	7111.32000
SK-B 40 / ER 32 x 160 H	4240.13283	50	–	160	–	405 / 405	7111.32000
SK-B 40 / ER 32 x 200 H	4240.13293	50	–	200	–	405 / 405	7111.32000
SK-B 40 / ER 40 x 080	2240.14043	63	–	80	–	–	7111.40000
SK-B 40 / ER 40 x 100 H	4240.14053	63	–	100	–	505	7111.40000
SK-B 40 / ER 40 x 160 H	4240.14083	63	–	160	–	505 / 505	7111.40000

* Balancing rings

Included in delivery: ER colletholders come with Hi-Q® / ER clamping nut. ERA colletholders come with Hi-Q® / ERAX clamping nuts.

H: Ready to accept balancing rings

Accessories are not included in delivery.

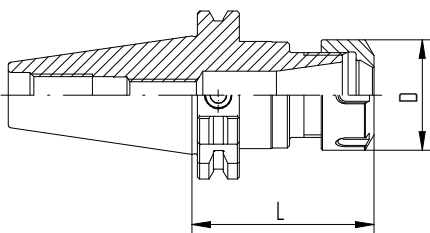

SK / ER (Form A+AD)

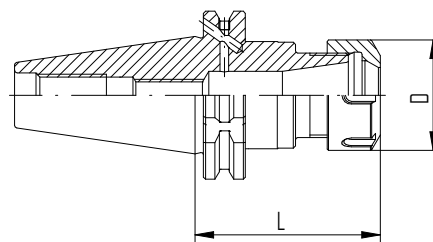

SK-B / ER (Form AD+B)

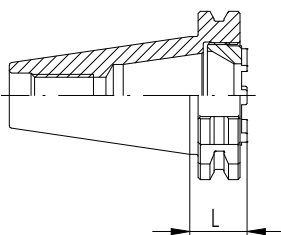

SK / ERA

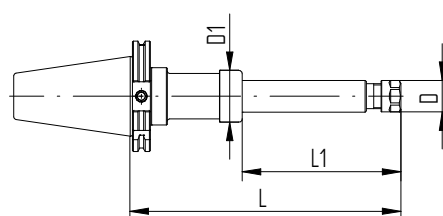

SK / ER XL (Form A+AD)

SK colletholders

SK-B colletholders

SK	SK-B
DIN 69871	DIN 69871
DIN ISO 7388-1	DIN ISO 7388-1

Type	Part no.	Dimensions [mm]				Accessories	
		D	D1	L	L1	FWR ...*	Wrench
SK 50							
SK 50/ER 16 x 100 H	4250.11650	28	–	100	–	505	7112.16010
SK 50/ER 16 x 160 H	4250.11680	28	–	160	–	505 / 225	7112.16010
SK 50/ER 16 x 200 H	4250.11690	28	–	200	–	505 / 225	7112.16010
SK 50/ER 16 x 240 XL	8852.13070	28	46	240	140	–	7112.16010
SK 50/ER 16 x 300 XL	8852.13130	28	46	300	140	–	7112.16010
SK 50/ER 16 x 340 XL	8852.13170	28	46	340	240	–	7112.16010
SK 50/ER 16 x 400 XL	8852.13230	28	46	400	240	–	7112.16010
SK 50/ER 20 x 070 H	4250.12030	34	–	70	–	325	7112.20010
SK 50/ER 20 x 100 H	4250.12050	34	–	100	–	325	7112.20010
SK 50/ER 25 x 070 H	4250.12530	42	–	70	–	405	7111.25000
SK 50/ER 25 x 100 H	4250.12550	42	–	100	–	405	7111.25000
SK 50/ER 25 x 160 H	4250.12580	42	–	160	–	405 / 325	7111.25000
SK 50/ER 25 x 200 H	4250.12590	42	–	200	–	405 / 325	7111.25000
SK 50/ER 32 x 100 H	4250.13250	50	–	100	–	505	7111.32000
SK 50/ER 32 x 160 H	4250.13280	50	–	160	–	505 / 405	7111.32000
SK 50/ER 32 x 200 H	4250.13290	50	–	200	–	505 / 405	7111.32000
SK 50/ER 32 x 320 XL	8852.16150	50	55	320	240	–	7111.32000
SK 50/ER 40 x 100 H	4250.14050	63	–	100	–	505	7111.40000
SK 50/ER 40 x 160 H	4250.14080	63	–	160	–	505 / 505	7111.40000
SK 50/ER 40 x 200 H	4250.14090	63	–	200	–	505 / 505	7111.40000
SK 50/ER 50 x 100	2250.15050	78	–	100	–	–	7111.50000
SK-B 50							
SK-B 50/ER 16 x 100 H	4250.11653	28	–	100	–	505	7112.16010
SK-B 50/ER 16 x 160 H	4250.11683	28	–	160	–	505 / 225	7112.16010
SK-B 50/ER 16 x 200 H	4250.11693	28	–	200	–	505 / 225	7112.16010
SK-B 50/ER 20 x 070 H	4250.12033	34	–	70	–	325	7112.20010
SK-B 50/ER 20 x 100 H	4250.12053	34	–	100	–	325	7112.20010
SK-B 50/ER 25 x 070 H	4250.12533	42	–	70	–	405	7111.25000
SK-B 50/ER 25 x 100 H	4250.12553	42	–	100	–	405	7111.25000
SK-B 50/ER 25 x 160 H	4250.12583	42	–	160	–	405 / 325	7111.25000
SK-B 50/ER 25 x 200 H	4250.12593	42	–	200	–	405 / 325	7111.25000
SK-B 50/ER 32 x 100 H	4250.13253	50	–	100	–	505	7111.32000
SK-B 50/ER 32 x 160 H	4250.13283	50	–	160	–	505 / 405	7111.32000
SK-B 50/ER 32 x 200 H	4250.13293	50	–	200	–	505 / 405	7111.32000
SK-B 50/ER 40 x 100 H	4250.14053	63	–	100	–	505	7111.40000
SK-B 50/ER 40 x 160 H	4250.14083	63	–	160	–	505 / 505	7111.40000
SK-B 50/ER 40 x 200 H	4250.14093	63	–	200	–	505 / 505	7111.40000

* Balancing rings

Included in delivery: ER colletholders come with Hi-Q®/ER clamping nut. ERA colletholders come with Hi-Q®/ERAX clamping nuts.

H: Ready to accept balancing rings

Accessories are not included in delivery. Other XL sizes available on request.



We manufacture products we can be proud of. Together we aim for excellence in every step we take: from the inspiring idea to the finished product.

Passion for precision

Steep taper colletholders BT

Universally suitable for different machining applications, the BT interface colletholders cater to a variety of machining needs.

MAS 403 / JIS B 6339 / DIN ISO 7388-2

Features and benefits

Runout TIR $\leq 0.0001"$ (3 μ m)

Measured from inner taper to outer taper.

Taper accuracy AT3

Better spindle-to-holder fit and accuracy.

Surface finish max. Ra 0.25

Achieve high clamping force and high transferable torque.

Balancing

100 % balanced to G 2.5 @ 22,000 rpm.

Balancing in XL colletholders

100 % balanced to G 2.5 @ 5,000 rpm.

Hi-Q® balancing system

Ready to accept Hi-Q® balancing rings which allow for the offset of the imbalance introduced by the cutting tool up to 80,000 rpm depending on the balancing rings used. All colletholders with the additional type information "H" in the article name are designed for balancing rings.

Hi-Q® / ER clamping nut included in delivery

Guarantees highest clamping force and best balancing.

Vibration dampening

Our holders offer good vibration dampening to sustain a high surface finish and can help prevent chatter.



Information



BT / ER and BT / ER XL colletholders

Applications

These colletholders are designed for CNC-machining centers with an automatic tool changer. They are universally suitable for different machining applications. Their vibration dampening reduces spindle wear and extends tool life.

Balancing

REGO-FIX BT / ER colletholders are balanced to G 2.5 @ 22,000 rpm. Type H colletholders are ready to accept Hi-Q® balancing rings which allow precision-balancing of the system including cutting tool up to 80,000 rpm depending on the balancing rings used.

SK / ER XL available

Due to their good vibration-dampening installation, BT / ER XL holders are ideally suited in all machining processes where the standard length colletholders cannot be used.

For more details on our XL colletholders, please refer to page 15.

Special applications

When extra high clamping force is needed, e.g., when tapping with ER-GB, we recommend using our friction-bearing clamping nuts Hi-Q® / ERB and Hi-Q® / ERBC.

Matched tooling system for best fit

For highest precision and best results the entire machining system counts. Therefore REGO-FIX components are carefully matched for optimum fit and accuracy. This guarantees the best runout and balance.

For the influence of runout on tool life, please refer to page 3.

Expert advice

We recommend tightening the clamping nuts using a torque wrench.

For tightening torque recommendations, please refer to page 163.

Information



BT / ERA colletholders

Applications

These colletholders are specially designed for mill-turning machines, multitasking machines and small vertical machining centers. They have the well-known REGO-FIX surface finish and are manufactured to meet our high-precision standards. ERA colletholders possess superior rigidity due to the shortness of the holder. ERA Zero-Z® colletholders have the shortest possible projection to increase the Z axis travel of the machine and to allow larger workpieces to be machined.

Balancing

REGO-FIX BT/ ERA colletholders are balanced to G 2.5 @ 22,000 rpm. The Hi-Q® / ERAX clamping nut has been specially designed for applications where space is scarce.

For the influence of runout on tool life, please refer to the graph on page 3.

BT colletholders

ERA Zero-Z[®] colletholder

BT
MAS 403
JIS B 6339
DIN ISO 7388-2

1.1.3 | BT | BT-B

Type	Part no.	Dimensions [mm]				Accessories	
		D	D1	L	L1	FWR ...*	Wrench
BT 30							
BT 30/ER 11 x 050	2130.11110	19	–	50	–	–	7112.11010
BT 30/ER 11 x 100 H	4130.11150	19	–	100	–	225	7112.11010
BT 30/ER 16 x 050	2130.11610	28	–	50	–	–	7112.16010
BT 30/ER 16 x 080 H	4130.11640	28	–	80	–	285	7112.16010
BT 30/ER 16 x 100 H	4130.11650	28	–	100	–	285	7112.16010
BT 30/ERA 20 x 022	2130.12007	–	–	22	–	–	7117.20000
BT 30/ER 20 x 050	2130.12010	34	–	50	–	–	7112.20010
BT 30/ER 20 x 070 H	4130.12030	34	–	70	–	325	7112.20010
BT 30/ER 20 x 100 H	4130.12050	34	–	100	–	325	7112.20010
BT 30/ER 25 x 060 H	4130.12520	42	–	60	–	325	7111.25000
BT 30/ER 25 x 100 H	4130.12550	42	–	100	–	325	7111.25000
BT 30/ER 32 x 060	2130.13220	50	–	60	–	–	7111.32000
BT 30/ER 32 x 100 H	4130.13250	50	–	100	–	405	7111.32000

* Balancing rings

Included in delivery: ER colletholders come with Hi-Q[®]/ER clamping nut. ERA colletholders come with Hi-Q[®]/ERAX clamping nuts.

H: Ready to accept balancing rings

Accessories are not included in delivery.

XL: For more information on XL holders see page 15.

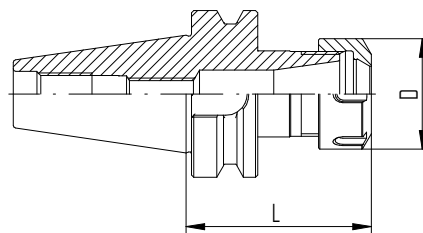

BT/ER (form A+AD)

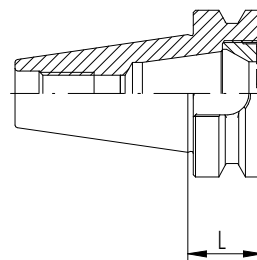

BT/ERA

BT colletholders

ERA Zero-Z® colletholder

BT

MAS 403

JIS B 6339

DIN ISO 7388-2

Type	Part no.	Dimensions [mm]				Accessories	
		D	D1	L	L1	FWR ...*	Wrench
BT 40							
BT 40/ER 11 x 100 H	4140.11150	19	–	100	–	285	7112.11010
BT 40/ER 11 x 160 H	4140.11180	19	–	160	–	285	7112.11010
BT 40/ER 16 x 070 H	4140.11630	28	–	70	–	285	7112.16010
BT 40/ER 16 x 100 H	4140.11650	28	–	100	–	285	7112.16010
BT 40/ER 16 x 160 H	4140.11680	28	–	160	–	285 / 225	7112.16010
BT 40/ER 16 x 220 XL	8841.13050	28	46	220	140	–	7112.16010
BT 40/ER 16 x 260 XL	8841.13090	28	46	260	140	–	7112.16010
BT 40/ER 16 x 300 XL	8841.13130	28	46	300	140	–	7112.16010
BT 40/ER 16 x 320 XL	8841.13150	28	46	320	240	–	7112.16010
BT 40/ER 16 x 360 XL	8841.13190	28	46	360	240	–	7112.16010
BT 40/ER 16 x 400 XL	8841.13230	28	46	400	240	–	7112.16010
BT 40/ER 20 x 070 H	4140.12030	34	–	70	–	325	7112.20010
BT 40/ER 20 x 100 H	4140.12050	34	–	100	–	285	7112.20010
BT 40/ER 20 x 160 H	4140.12080	34	–	160	–	405 / 285	7112.20010
BT 40/ER 25 x 070 H	4140.12530	42	–	70	–	325	7111.25000
BT 40/ER 25 x 100 H	4140.12550	42	–	100	–	405	7111.25000
BT 40/ER 25 x 160 H	4140.12580	42	–	160	–	405 / 325	7111.25000
BT 40/ERA 32 x 27	2140.13207	–	–	27	–	–	7117.32000
BT 40/ER 32 x 070 H	4140.13230	50	–	70	–	405	7111.32000
BT 40/ER 32 x 100 H	4140.13250	50	–	100	–	405	7111.32000
BT 40/ER 32 x 160 H	4140.13280	50	–	160	–	405 / 405	7111.32000
BT 40/ER 32 x 226 XL	8841.16050	50	55	226	140	–	7111.32000
BT 40/ER 32 x 326 XL	8841.16150	50	55	326	240	–	7111.32000
BT 40/ER 40 x 080	2140.14040	63	–	80	–	–	7111.40000
BT 40/ER 40 x 100 H	4140.14050	63	–	100	–	505	7111.40000
BT 40/ER 40 x 160 H	4140.14080	63	–	160	–	505 / 505	7111.40000

* Balancing rings

Included in delivery: ER colletholders come with Hi-Q® / ER clamping nut. ERA colletholders come with Hi-Q® / ERAX clamping nuts.

H: Ready to accept balancing rings

Accessories are not included in delivery. Other XL sizes available on request.

XL: For more information on XL holders see page 15.

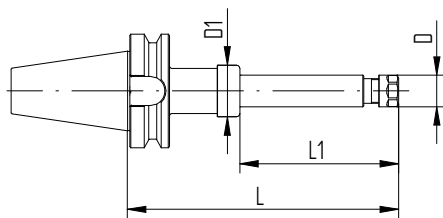

BT/ER XL

Expert advice

For additional technical drawings and details, see the REGO-FIX website at www.rego-fix.com

BT / BT-B colletholders

BT	BT-B
MAS 403	
JIS B 6339	
DIN ISO 7388-2	

Type	Part no.	Dimensions [mm]				Accessories	
		D	D1	L	L1	FWR ...*	Wrench
BT-B 40							
BT-B 40 / ER 16 x 070 H	4140.11633	28	–	70	–	285	7112.16010
BT-B 40 / ER 16 x 100 H	4140.11653	28	–	100	–	285	7112.16010
BT-B 40 / ER 16 x 160 H	4140.11683	28	–	160	–	285 / 225	7112.16010
BT-B 40 / ER 20 x 070 H	4140.12033	34	–	70	–	325	7112.20010
BT-B 40 / ER 20 x 100 H	4140.12053	34	–	100	–	285	7112.20010
BT-B 40 / ER 20 x 160 H	4140.12083	34	–	160	–	405 / 285	7112.20010
BT-B 40 / ER 25 x 070 H	4140.12533	42	–	70	–	325	7111.25000
BT-B 40 / ER 25 x 100 H	4140.12553	42	–	100	–	405	7111.25000
BT-B 40 / ER 25 x 160 H	4140.12583	42	–	160	–	405 / 325	7111.25000
BT-B 40 / ER 32 x 070 H	4140.13233	50	–	70	–	405	7111.32000
BT-B 40 / ER 32 x 100 H	4140.13253	50	–	100	–	405	7111.32000
BT-B 40 / ER 32 x 160 H	4140.13283	50	–	160	–	405 / 405	7111.32000
BT-B 40 / ER 40 x 080	2140.14043	63	–	80	–	–	7111.40000
BT-B 40 / ER 40 x 100 H	4140.14053	63	–	100	–	505	7111.40000
BT-B 40 / ER 40 x 160 H	4140.14083	63	–	160	–	505 / 505	7111.40000
BT 50							
BT 50 / ER 16 x 100 H	4150.11650	28	–	100	–	505	7112.16010
BT 50 / ER 16 x 160 H	4150.11680	28	–	160	–	505 / 225	7112.16010
BT 50 / ER 16 x 240 XL	8851.13070	28	46	240	140	–	7112.16010
BT 50 / ER 16 x 260 XL	8851.13090	28	46	260	140	–	7112.16010
BT 50 / ER 16 x 300 XL	8851.13130	28	46	300	140	–	7112.16010
BT 50 / ER 16 x 340 XL	8851.13170	28	46	340	240	–	7112.16010
BT 50 / ER 16 x 360 XL	8851.13190	28	46	360	240	–	7112.16010
BT 50 / ER 16 x 400 XL	8851.13230	28	46	400	240	–	7112.16010
BT 50 / ER 20 x 070	2150.12030	34	–	70	–	–	7112.20010
BT 50 / ER 20 x 100 H	4150.12050	34	–	100	–	325	7112.20010
BT 50 / ER 25 x 070	2150.12530	42	–	70	–	–	7111.25000
BT 50 / ER 25 x 100 H	4150.12550	42	–	100	–	405	7111.25000
BT 50 / ER 25 x 160 H	4150.12580	42	–	160	–	405 / 325	7111.25000
BT 50 / ER 32 x 100 H	4150.13250	50	–	100	–	505	7111.32000
BT 50 / ER 32 x 160 H	4150.13280	50	–	160	–	505 / 405	7111.32000
BT 50 / ER 32 x 200 H	4150.13290	50	–	200	–	505 / 405	7111.32000
BT 50 / ER 32 x 240 XL	8851.16070	50	55	240	140	–	7111.32000
BT 50 / ER 32 x 340 XL	8851.16170	50	55	340	240	–	7111.32000
BT 50 / ER 40 x 100 H	4150.14050	63	–	100	–	505	7111.40000
BT 50 / ER 40 x 160 H	4150.14080	63	–	160	–	505 / 505	7111.40000
BT 50 / ER 50 x 100	2150.15050	78	–	100	–	–	7111.50000

* Balancing rings

Included in delivery: ER colletholders come with Hi-Q®/ER clamping nut. ERA colletholders come with Hi-Q®/ERAX clamping nuts.

H: Ready to accept balancing rings

Accessories are not included in delivery. Other XL sizes available on request.

Type	Part no.	Dimensions [mm]				Accessories	
		D	D1	L	L1	FWR ...*	Wrench
BT-B 50							
BT-B 50/ER 16 x 100 H	4150.11653	28	–	100	–	505	7112.16010
BT-B 50/ER 16 x 160 H	4150.11683	28	–	160	–	505 / 225	7112.16010
BT-B 50/ER 20 x 070	2150.12033	34	–	70	–	–	7112.20010
BT-B 50/ER 20 x 100 H	4150.12053	34	–	100	–	325	7112.20010
BT-B 50/ER 25 x 070	2150.12533	42	–	70	–	–	7111.25000
BT-B 50/ER 25 x 100 H	4150.12553	42	–	100	–	405	7111.25000
BT-B 50/ER 25 x 160 H	4150.12583	42	–	160	–	405 / 325	7111.25000
BT-B 50/ER 32 x 100 H	4150.13253	50	–	100	–	505	7111.32000
BT-B 50/ER 32 x 160 H	4150.13283	50	–	160	–	505 / 405	7111.32000
BT-B 50/ER 40 x 100 H	4150.14053	63	–	100	–	505	7111.40000
BT-B 50/ER 40 x 160 H	4150.14083	63	–	160	–	505 / 505	7111.40000

* Balancing rings

Included in delivery: ER colletholders come with Hi-Q®/ER clamping nut. ERA colletholders come with Hi-Q®/ERAX clamping nuts.

H: Ready to accept balancing rings

Accessories are not included in delivery. Other XL sizes available on request.

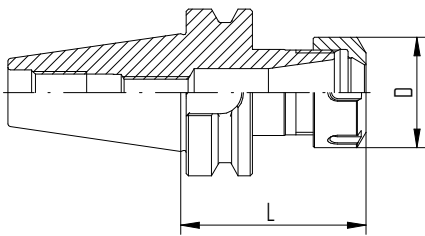

BT/ER (form A+AD)

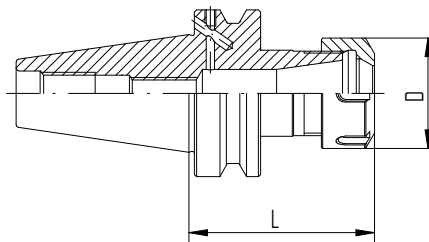

BT-B/ER (form AD+B)

Expert advice

What is the difference between form A+AD and AD+B?
 Form A+AD: coolant supply through the taper
 Form AD+B: coolant supply through the flange

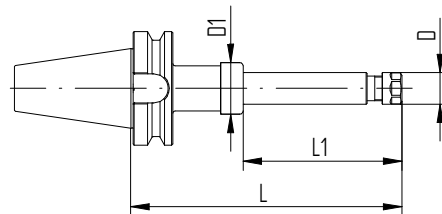

BT/ER XL

BT-OM colletholders

ERA Zero-Z® colletholder

BT-OM

HAAS

HURCO

Type	Part no.	Dimensions [mm]				Accessories	
		D	D1	L	L1	FWR ...*	Wrench
BT-OM							
BT-OM 30 / ER 16 x 080 H	4130.11648	28	–	80	–	285	7112.16010
BT-OM 30 / ER 25 x 060 H	4130.12528	42	–	60	–	325	7111.25000
BT-OM 30 / ER 32 x 060	2130.13228	50	–	60	–	–	7111.32000
BT-OM 30 / ERA 20 x 022	2130.12008	–	–	22	–	–	7117.20000

* Balancing rings

Included in delivery: ER colletholders come with Hi-Q® / ER clamping nut. ERA colletholders come with Hi-Q® / ERAX clamping nut.

H: Ready to accept balancing rings

Accessories are not included in delivery.

Information

BT-OM / ER colletholders without drive slots

Applications

This special colletholder without drive slots is designed for use on HAAS and HURCO CNC-machining centers.

Special applications

When extra high clamping force is needed, e.g., when tapping with ER-GB, we recommend to use our friction-bearing clamping nuts Hi-Q® / ERB* and Hi-Q® / ERBC*.

* Not for use with ERA colletholders.

Balancing

REGO-FIX BT-OM / ER(A) colletholders are balanced to G 2.5 @ 22,000 rpm. Type H colletholders are compatible with Hi-Q® balancing rings which allow precision-balancing of the entire system including cutting tool up to 80,000 rpm depending on the balancing rings used.

Matched tooling system for best fit

For highest precision and best results the entire machining system counts. Therefore REGO-FIX components are carefully matched for optimum fit and accuracy. This guarantees the best runout and balance.

For the influence of runout on tool life, please refer to page 3.

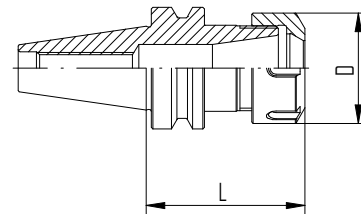

BT-OM / ER

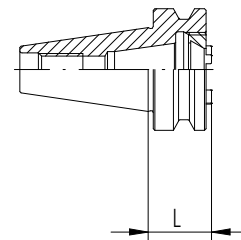

BT-OM / ERA



All our products are manufactured to meet our high demands in engineering and design. We say Swiss made and we mean it. Products marked Swiss made are manufactured at our headquarters in Tenniken, Switzerland.

True Swiss quality

BT+ REGO PLUS dual contact colletholders

Certified The BIG PLUS SYSTEM – licensed by BIG Daishowa – is manufactured at REGO-FIX in Switzerland under license according to BIG PLUS specifications.

Key advantages

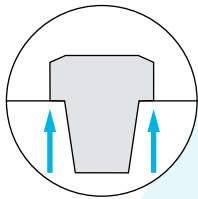

Higher colletholder stiffness due to taper (AT1) and face contact

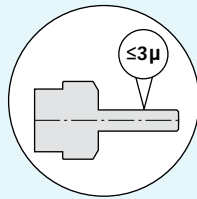

Improved machining accuracy and better surface finish

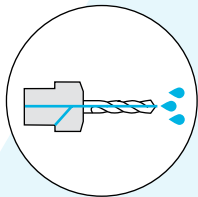

Form AD+B as standard configuration



Type	Part no. AD+B	Dimensions [mm]				Accessories	
		D	D1	L	L1	FWR ...*	Wrench
BT+ 30							
BT+ 30/ER 11 x 100 H	4130.11156	19	–	100	–	225	7112.11010
BT+ 30/ER 16 x 050	2130.11616	28	–	50	–	–	7112.16010
BT+ 30/ER 16 x 080 H	4130.11646	28	–	80	–	285	7112.16010
BT+ 30/ER 20 x 050	2130.12016	34	–	50	–	–	7112.20010
BT+ 30/ER 20 x 070 H	4130.12036	34	–	70	–	325	7112.20010
BT+ 30/ER 25 x 060 H	4130.12526	42	–	60	–	325	7111.25000
BT+ 30/ER 32 x 060	2130.13226	50	–	60	–	–	7111.32000
BT+ 40							
BT+ 40/ER 16 x 070 H	4140.11636	28	–	70	–	285	7112.16010
BT+ 40/ER 16 x 100 H	4140.11656	28	–	100	–	285	7112.16010
BT+ 40/ER 20 x 070 H	4140.12036	34	–	70	–	325	7112.20010
BT+ 40/ER 25 x 070 H	4140.12536	42	–	70	–	325	7111.25000
BT+ 40/ER 32 x 070 H	4140.13236	50	–	70	–	405	7111.32000
BT+ 40/ER 32 x 100 H	4140.13256	50	–	100	–	405	7111.32000
BT+ 40/ER 32 x 160 H	4140.13286	50	–	160	–	405 / 405	7111.32000
BT+ 50							
BT+ 50/ER 32 x 100 H	4150.13256	50	–	100	–	505	7111.32000
BT+ 50/ER 32 x 160 H	4150.13286	50	–	160	–	505 / 405	7111.32000

* Balancing rings H: Ready to accept balancing rings

Included in delivery: Colletholders come with Hi-Q®/ER clamping nut.

Accessories are not included in delivery.

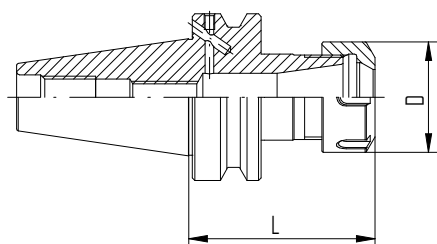

Expert advice

For additional technical drawings and details, see the REGO-FIX website at www.rego-fix.com

HSK colletholders

Designed for rotating applications, all our HSK colletholders are suited for high-speed applications where a consistent performance is key.

DIN 69893 / ISO 12164

Features and benefits

Runout TIR $\leq 0.0001''$ (3 μ m)

Measured from inner taper to outer taper.

Surface finish max. Ra 0.25

Achieve high clamping force and high transferable torque.

Balancing

100% balanced to G 2.5 @ 25,000 rpm.

Balancing in XL colletholders

100% balanced to G 2.5 @ 5,000 rpm.

Hi-Q® balancing system

Ready to accept Hi-Q® balancing rings which allow for the offset of the imbalance introduced by the cutting tool up to 80,000 rpm depending on the balancing rings used. All colletholders with the additional type information "H" in the article name are designed for balancing rings.

Hi-Q® / ER clamping nut included in delivery

Guarantees highest clamping force and best balancing.

Vibration dampening

Our holders offer a good vibration dampening to sustain a high surface finish and can prevent cutting force alterations.

Special applications

When extra high clamping force is needed, e.g., when tapping with ER-GB, we recommend to use our friction-bearing clamping nuts Hi-Q® / ERB and Hi-Q® / ERBC.

Matched tooling system for best fit

For highest precision and best results the entire machining system counts. Therefore our components are carefully matched for optimum fit and accuracy. This guarantees the best runout and balance.

ID chip hole (only HSK form A+B)

In accordance with DIN 69873 for 10 mm diameter.

Expert advice

For all HSK-A and HSK-E form colletholders a range of coolant tubes (KSR) is available.

For KSR part numbers please refer to page 155.

Q+® Balancing

100% balanced to lowest possible residual imbalance

HSK 25*	balanced to 90,000 rpm
HSK 32*	balanced to 60,000 rpm
HSK 40*	balanced to 45,000 rpm
HSK 50*	balanced to 36,000 rpm
HSK 63	G 2.5 @ 25,000 rpm
HSK 80	G 2.5 @ 25,000 rpm
HSK 100	G 2.5 @ 25,000 rpm
HSK 125	G 2.5 @ 25,000 rpm

* Only pertains to HSK-A and HSK-E toolholders. All HSK-C toolholders are balanced to G 2.5 @ 25,000 rpm.



HSK forms and their key characteristics

HSK

DIN 69893

ISO 12164

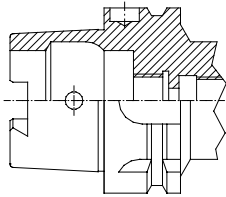

Form A*

- // Standard type for machining centers and milling machines
- // For automatic tool change
- // Coolant supply through center via coolant tube
- // Drive keys at the end of HSK taper
- // Hole for data carrier DIN STD 69873 in the flange

* Also usable in form C applications with side hole for manual tool change

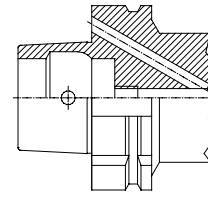

Form B

- // For machining centers, milling and turning machines
- // With enlarged flange size for higher radial rigidity
- // For automatic tool change
- // Coolant supply through the flange
- // Drive keys at the flange
- // Hole for data carrier DIN STD 69873 at the flange

Available on request.

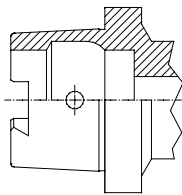

Form C

- // For transfer lines, special machines and modular tooling systems
- // For manual tool change
- // Drive keys at the end of HSK taper

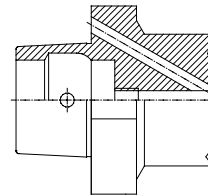

Form D

- // For special machines
- // With enlarged flange size for higher radial rigidity
- // For manual tool change
- // Coolant supply through the flange
- // Drive keys at the flange

Available on request.

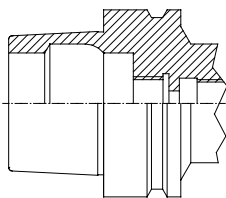

Form E

- // For high-speed applications
- // For automatic tool change
- // Coolant supply through center via coolant tube
- // Without any drive keys for absolute symmetry

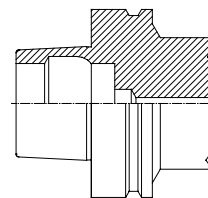

Form F

- // For high-speed applications
- // For automatic tool change
- // With enlarged flange size for higher radial rigidity
- // Without any drive keys for absolute symmetry

Type	Part no.	Dimensions [mm]				Accessories	
		D	D1	L	L1	FWR ...*	Wrench
HSK-A 32							
HSK-A 32 / ER 11 x 050	2532.11110	19	–	50	–	–	7112.11010
HSK-A 32 / ER 16 x 060	2532.11620	28	–	60	–	–	7112.16010
HSK-A 32 / ER 20 x 060	2532.12020	34	–	60	–	–	7112.20010
HSK-A 32 / ER 25 x 065	2532.12520	42	–	65	–	–	7111.25000
HSK-A 40							
HSK-A 40 / ER 16 x 080 H	4540.11640	28	–	80	–	225	7112.16010
HSK-A 40 / ER 25 x 080 H	4540.12540	42	–	80	–	325	7111.25000
HSK-A 50							
HSK-A 50 / ER 16 x 100 H	4550.11650	28	–	100	–	325	7112.16010
HSK-A 50 / ER 25 x 080 H	4550.12540	42	–	80	–	325	7111.25000
HSK-A 50 / ER 25 x 100 H	4550.12550	42	–	100	–	325	7111.25000
HSK-A 50 / ER 32 x 100 H	4550.13250	50	–	100	–	405	7111.32000
HSK-A 63							
HSK-A 63 / ER 11 x 100 H	4563.11150	19	–	100	–	325	7112.11010
HSK-A 63 / ER 16 x 080 H	4563.11640	28	–	80	–	325	7112.16010
HSK-A 63 / ER 16 x 100 H	4563.11650	28	–	100	–	325	7112.16010
HSK-A 63 / ER 16 x 160 H	4563.11680	28	–	160	–	325 / 225	7112.16010
HSK-A 63 / ER 16 x 240 XL	8865.13070	28	46	240	140	–	7112.16010
HSK-A 63 / ER 16 x 260 XL	8865.13090	28	46	260	140	–	7112.16010
HSK-A 63 / ER 16 x 300 XL	8865.13130	28	46	300	140	–	7112.16010
HSK-A 63 / ER 16 x 340 XL	8865.13170	28	46	340	240	–	7112.16010
HSK-A 63 / ER 16 x 360 XL	8865.13190	28	46	360	240	–	7112.16010
HSK-A 63 / ER 16 x 400 XL	8865.13230	28	46	400	240	–	7112.16010
HSK-A 63 / ER 20 x 075	2563.12030	34	–	75	–	–	7112.20010
HSK-A 63 / ER 25 x 080 H	4563.12540	42	–	80	–	325	7111.25000
HSK-A 63 / ER 25 x 100 H	4563.12550	42	–	100	–	325	7111.25000
HSK-A 63 / ER 25 x 160 H	4563.12580	42	–	160	–	325	7111.25000
HSK-A 63 / ER 25 x 200 H	4563.12590	42	–	200	–	405 / 325	7111.25000
HSK-A 63 / ER 32 x 080 H	4563.13240	50	–	80	–	405	7111.32000
HSK-A 63 / ER 32 x 100 H	4563.13250	50	–	100	–	405	7111.32000
HSK-A 63 / ER 32 x 160 H	4563.13280	50	–	160	–	405	7111.32000
HSK-A 63 / ER 32 x 200 H	4563.13290	50	–	200	–	405 / 405	7111.32000
HSK-A 63 / ER 32 x 240 XL	8865.16070	50	55	240	140	–	7111.32000
HSK-A 63 / ER 32 x 260 XL	8865.16090	50	55	260	140	–	7111.32000
HSK-A 63 / ER 32 x 340 XL	8865.16170	50	55	340	240	–	7111.32000
HSK-A 63 / ER 32 x 360 XL	8865.16190	50	55	360	240	–	7111.32000

* Balancing rings H: Ready to accept balancing rings

Accessories are not included in delivery.

Type	Part no.	Dimensions [mm]				Accessories	
		D	D1	L	L1	FWR ...*	Wrench
HSK-A 63 / ER 40 x 080	2563.14040	63	–	80	–	–	7111.40000
HSK-A 63 / ER 40 x 120 H	4563.14060	63	–	120	–	505	7111.40000
HSK-A 63 / ER 40 x 160 H	4563.14080	63	–	160	–	505	7111.40000

HSK-A 80

HSK-A 80 / ER 16 x 100 H	4580.11650	28	–	100	–	325	7112.16010
HSK-A 80 / ER 16 x 160 H	4580.11680	28	–	160	–	325 / 225	7112.16010
HSK-A 80 / ER 32 x 100 H	4580.13250	50	–	100	–	405	7111.32000
HSK-A 80 / ER 40 x 120 H	4580.14060	63	–	120	–	505	7111.40000

HSK-A 100

HSK-A 100 / ER 16 x 100 H	4500.11650	28	–	100	–	405	7112.16010
HSK-A 100 / ER 16 x 160 H	4500.11680	28	–	160	–	405 / 225	7112.16010
HSK-A 100 / ER 16 x 200 H	4500.11690	28	–	200	–	405 / 225	7112.16010
HSK-A 100 / ER 16 x 240 XL	8885.13070	28	46	240	140	–	7112.16010
HSK-A 100 / ER 16 x 300 XL	8885.13130	28	46	300	140	–	7112.16010
HSK-A 100 / ER 16 x 340 XL	8885.13170	28	46	340	240	–	7112.16010
HSK-A 100 / ER 16 x 400 XL	8885.13230	28	46	400	240	–	7112.16010
HSK-A 100 / ER 25 x 100 H	4500.12550	42	–	100	–	405	7111.25000
HSK-A 100 / ER 25 x 160 H	4500.12580	42	–	160	–	405 / 325	7111.25000
HSK-A 100 / ER 25 x 200 H	4500.12590	42	–	200	–	405 / 325	7111.25000
HSK-A 100 / ER 32 x 100 H	4500.13250	50	–	100	–	405	7111.32000
HSK-A 100 / ER 32 x 160 H	4500.13280	50	–	160	–	405	7111.32000
HSK-A 100 / ER 32 x 246 XL	8885.16070	50	55	246	140	–	7111.32000
HSK-A 100 / ER 32 x 346 XL	8885.16170	50	55	346	240	–	7111.32000
HSK-A 100 / ER 40 x 120 H	4500.14060	63	–	120	–	505	7111.40000
HSK-A 100 / ER 40 x 200 H	4500.14090	63	–	200	–	505 / 505	7111.40000

* Balancing rings H: Ready to accept balancing rings

Included in delivery: Colletholders with Hi-Q® / ER clamping nut and back-up screw.

XL: For more information on XL holders see page 15.

Accessories are not included in delivery. HSK-A 125 available on request. Other XL sizes available on request.

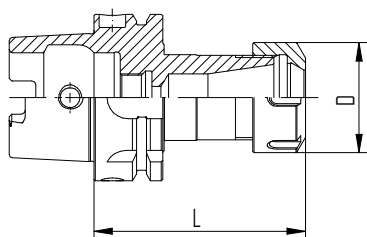

HSK-A / ER

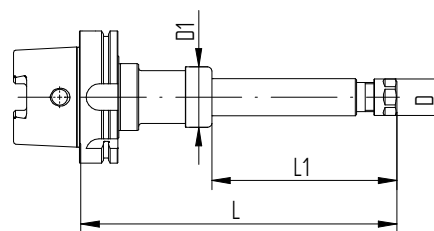

HSK-A / ER XL

Type	Part no.	Dimensions [mm]				Accessories	
		D	D1	L	L1	FWR ...*	Wrench
HSK-C 32							
HSK-C 32 / ER 16 x 060	2532.11622	28	–	60	–	–	7112.16010
HSK-C 32 / ER 20 x 060	2532.12022	34	–	60	–	–	7112.20010
HSK-C 32 / ER 25 x 070	2532.12532	42	–	70	–	–	7111.25000
HSK-C 40							
HSK-C 40 / ER 20 x 060	2540.12022	34	–	60	–	–	7112.20010
HSK-C 40 / ER 25 x 070	2540.12532	42	–	70	–	–	7111.25000
HSK-C 40 / ER 32 x 075	2540.13232	50	–	75	–	–	7111.32000
HSK-C 50							
HSK-C 50 / ER 25 x 070	2550.12532	42	–	70	–	–	7111.25000
HSK-C 50 / ER 32 x 075	2550.13232	50	–	75	–	–	7111.32000
HSK-C 50 / ER 40 x 080	2550.14042	63	–	80	–	–	7111.40000
HSK-C 63							
HSK-C 63 / ER 32 x 075	2563.13232	50	–	75	–	–	7111.32000
HSK-C 63 / ER 40 x 080	2563.14042	63	–	80	–	–	7111.40000

* Balancing rings H: Ready to accept balancing rings

Included in delivery: Colletholders with Hi-Q® / ER clamping nut and back-up screw.

Accessories are not included in delivery.

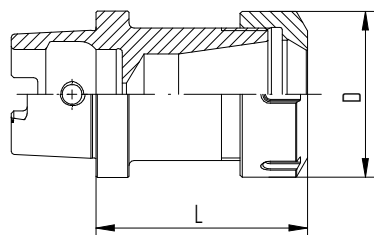

HSK-C / ER

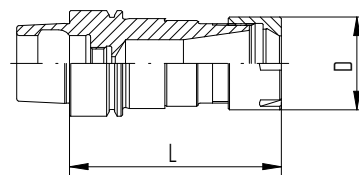

HSK-E / ER M

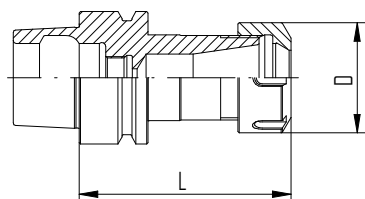

HSK-E / ER

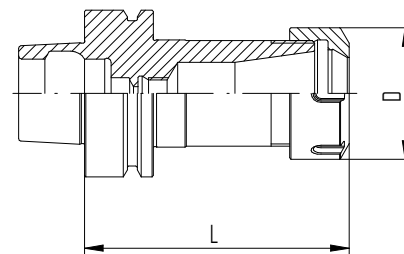

HSK-F / ER

HSK-E colletholders

HSK-F colletholders

HSK-E	HSK-F
DIN 69893	DIN 69893
ISO 12164	ISO 12164

Type	Part no.	Dimensions [mm]				Accessories	
		D	D1	L	L1	FWR ...*	Wrench
HSK-E 25							
HSK-E 25 / ERM 16 x 048	2525.11618	22	–	48	–	–	7113.16000
HSK-E 32							
HSK-E 32 / ERM 16 x 060	2532.11628	22	–	60	–	–	7113.16000
HSK-E 32 / ERM 20 x 060	2532.12028	28	–	60	–	–	7113.20000
HSK-E 40							
HSK-E 40 / ER 11 x 060 H	4540.11124	19	–	60	–	225	7112.11010
HSK-E 40 / ER 16 x 060 H	4540.11624	28	–	60	–	225	7112.16010
HSK-E 40 / ER 16 x 080 H	4540.11644	28	–	80	–	225	7112.16010
HSK-E 40 / ERM 20 x 075 H	4540.12038	28	–	75	–	285	7113.20000
HSK-E 40 / ERM 25 x 080 H	4540.12548	35	–	80	–	325	7113.25000
HSK-E 50							
HSK-E 50 / ER 16 x 060	2550.11624	28	–	60	–	–	7112.16010
HSK-E 50 / ER 16 x 100 H	4550.11654	28	–	100	–	325	7112.16010
HSK-E 50 / ER 16 x 160 H	4550.11684	28	–	160	–	325 / 225	7112.16010
HSK-E 50 / ER 20 x 070 H	4550.12034	34	–	70	–	325	7112.20010
HSK-E 50 / ER 25 x 080 H	4550.12544	42	–	80	–	325	7111.25000
HSK-E 50 / ER 25 x 100 H	4550.12554	42	–	100	–	325	7111.25000
HSK-E 50 / ER 32 x 100 H	4550.13254	50	–	100	–	405	7111.32000
HSK-E 50 / ER 32 x 160 H	4550.13284	50	–	160	–	405	7111.32000
HSK-E 63							
HSK-E 63 / ER 32 x 090 H	4563.13244	50	–	90	–	405	7111.32000
HSK-E 63 / ER 40 x 080	2563.14044	63	–	80	–	–	7111.40000
HSK-E 63 / ER 40 x 120 H	4563.14064	63	–	120	–	505	7111.40000
HSK-F 63							
HSK-F 63 / ER 16 x 100 H	4563.11655	28	–	100	–	325	7112.16010
HSK-F 63 / ER 25 x 100 H	4563.12555	42	–	100	–	325	7111.25000
HSK-F 63 / ER 32 x 100 H	4563.13255	50	–	100	–	405	7111.32000
HSK-F 63 / ER 40 x 120 H	4563.14065	63	–	120	–	505	7111.40000

* Balancing rings H: Ready to accept balancing rings

Included in delivery: Colletholders with Hi-Q®/ER clamping nut and back-up screw.

Accessories are not included in delivery. HSK-E 20 available on request. Other XL sizes available on request.

REGO-FIX CAPTO colletholders

These self-centering and balanced colletholders enable high-torque transmission and show a high-bending strength.

ISO 12164

Features and benefits

Runout TIR $\leq 0.0001''$ ($3\mu\text{m}$)

Measured from inner taper to outer taper.

Surface finish max. Ra 0.25

Achieve high clamping force and high transferable torque.

Balancing

100 % balanced to G 2.5 @ 25,000 rpm.

Balancing in XL colletholders

100 % balanced to G 2.5 @ 5,000 rpm.

Hi-Q® balancing system

Ready to accept Hi-Q® balancing rings which allow for the offset of the imbalance introduced by the cutting tool up to 80,000 rpm depending on the balancing rings used. All colletholders with the additional type information "H" in the article name are designed for balancing rings.

Hi-Q® / ER clamping nut included in delivery

Guarantees highest clamping force and best balancing.

Vibration dampening

Our holders offer a good vibration dampening to sustain a high surface finish and can prevent cutting force alterations.

Certified REGO-FIX CAPTO – licensed by Sandvik Coromant – is manufactured at REGO-FIX Switzerland under license according to CAPTO specifications.

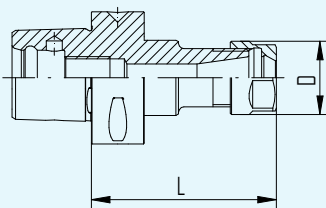

C/ER

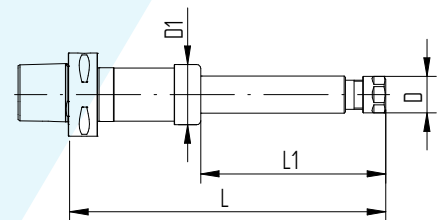

C/ER XL

Type	Part no.	Dimensions [mm]				Accessories	
		D	D1	L	L1	FWR ...*	Wrench
C3							
C3 / ER 16 x 045	2803.11610	28	–	45	–	–	7112.16010
C3 / ER 20 x 045	2803.12010	34	–	45	–	–	7112.20010
C4							
C4 / ER 16 x 070	2804.11630	28	–	70	–	–	7112.16010
C4 / ER 20 x 052	2804.12010	34	–	52	–	–	7112.20010
C4 / ER 25 x 052	2804.12510	42	–	52	–	–	7111.25000
C4 / ER 32 x 054	2804.13210	50	–	54	–	–	7111.32000
C5							
C5 / ER 16 x 070 H	4805.11630	28	–	70	–	285	7112.16010
C5 / ER 16 x 100 H	4805.11650	28	–	100	–	285	7112.16010
C5 / ER 20 x 055	2805.12010	34	–	55	–	–	7112.20010
C5 / ER 20 x 100 H	4805.12050	34	–	100	–	325	7112.20010
C5 / ER 25 x 055	2805.12510	42	–	55	–	–	7111.25000
C5 / ER 25 x 100 H	4805.12550	42	–	100	–	405	7111.25000
C5 / ER 32 x 057	2805.13210	50	–	57	–	–	7111.32000
C5 / ER 32 x 070 H	4805.13230	50	–	70	–	405	7111.32000
C5 / ER 32 x 100H	4805.13250	50	–	100	–	405	7111.32000
C6							
C6 / ER 11 x 150 H	4806.11170	19	–	150	–	325	7112.11010
C6 / ER 16 x 070 H	4806.11630	28	–	70	–	325	7112.16010
C6 / ER 16 x 100 H	4806.11650	28	–	100	–	325	7112.16010
C6 / ER 16 x 150 H	4806.11670	28	–	150	–	325	7112.16010
C6 / ER 16 x 225 XL	8886.13050	28	46	225	140	–	7112.16010
C6 / ER 16 x 240 XL	8886.13070	28	46	240	140	–	7112.16010
C6 / ER 16 x 260 XL	8886.13090	28	46	260	140	–	7112.16010
C6 / ER 16 x 300 XL	8886.13130	28	46	300	140	–	7112.16010
C6 / ER 16 x 325 XL	8886.13150	28	46	325	240	–	7112.16010
C6 / ER 16 x 340 XL	8886.13170	28	46	340	240	–	7112.16010
C6 / ER 16 x 360 XL	8886.13190	28	46	360	240	–	7112.16010
C6 / ER 16 x 400 XL	8886.13230	28	46	400	240	–	7112.16010
C6 / ER 20 x 060	2806.12020	34	–	60	–	–	7112.20010

* Balancing rings H: Ready to accept balancing rings

Included in delivery: Colletholder with Hi-Q® / ER clamping nut. Accessories are not included in delivery.

XL: For more information on XL holders see page 15.

Other XL sizes available on request. All REGO-FIX CAPTO holders are also available with an ID chip hole on request.

Type	Part no.	Dimensions [mm]				Accessories	
		D	D1	L	L1	FWR ...*	Wrench
C6 continued							
C6 / ER 25 x 060	2806.12520	42	–	60	–	–	7111.25000
C6 / ER 25 x 100 H	4806.12550	42	–	100	–	405	7111.25000
C6 / ER 25 x 130 H	4806.12560	42	–	130	–	405	7111.25000
C6 / ER 32 x 060	2806.13220	50	–	60	–	–	7111.32000
C6 / ER 32 x 070 H	4806.13230	50	–	70	–	405	7111.32000
C6 / ER 32 x 100 H	4806.13250	50	–	100	–	505	7111.32000
C6 / ER 32 x 230 XL	8886.16060	50	55	230	140	–	7111.32000
C6 / ER 32 x 330 XL	8886.16160	50	55	330	240	–	7111.32000
C6 / ER 40 x 065	2806.14020	63	–	65	–	–	7111.40000

C8							
C8 / ER 16 x 232 XL	8888.13060	28	46	232	140	–	7112.16010
C8 / ER 16 x 332 XL	8888.13160	28	46	332	240	–	7112.16010
C8 / ER 25 x 070	2808.12530	42	–	70	–	–	7111.25000
C8 / ER 32 x 070	2808.13230	50	–	70	–	–	7111.32000
C8 / ER 32 x 230 XL	8888.16060	50	55	230	140	–	7111.32000
C8 / ER 32 x 330 XL	8888.16160	50	55	330	240	–	7111.32000
C8 / ER 40 x 070	2808.14030	63	–	70	–	–	7111.40000
C8 / ER 50 x 080	2808.15040	78	–	80	–	–	7111.50000

* Balancing rings H: Ready to accept balancing rings

Included in delivery: Colletholder with Hi-Q® / ER clamping nut. Accessories are not included in delivery.

XL: For more information on XL holders see page 15.

Other XL sizes available on request. All REGO-FIX CAPTO holders are also available with an ID chip hole on request.



C / ER

Expert advice

We recommend tightening the clamping nuts using a torque wrench.

For tightening torque recommendations, please refer to page 163.

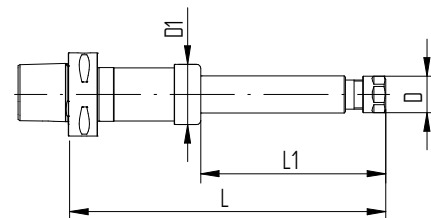

C / ER XL



Cylindrical shank collets CYL



CYL / CYLF / CYDF

Features and benefits

Runout TIR ≤ 0.0001 " (3 μ m) for CYL / ERM and CYL / ERMX

Measured from inner taper to outer shank.

Runout TIR ≤ 0.0002 " (5 μ m) for CYLF / ERM and CYLF / ERMX

Measured from inner taper to outer shank.

Runout TIR ≤ 0.0002 " (5 μ m) for CYDF / ERM and CYDF / ERMX

Measured from inner taper to outer shank.

Surface finish max. Ra 0.25

Achieve high clamping force and high transferable torque.

Sizes

ER 8 – ER 40

h6 tolerance on shanks.

Types

Cylindrical, flat- or double-ended collets.

Expert advice

We recommend tightening the clamping nuts using a torque wrench.

For tightening torque recommendations, please refer to page 163.

Available CYL colletholders and their key characteristics

Cylindrical REGO-FIX colletholders are designed for automatic turning machines and can also be utilized as extensions. We offer many different product types to fit your machining needs.

CYL/ER

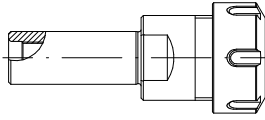

CYL/ER The short versions are particularly used on turret lathes, where a short overhang is often required.

For technical dimensions, please refer to page 54.

CYL/ERM

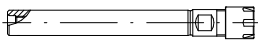

CYL/ERM This type is suited for Swiss automatic machines, machining centers and conventional machines. Can be used as extension.

For technical dimensions, please refer to page 56.

CYL/ERMX

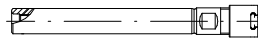

CYL/ERMX This type is suited for Swiss automatic machines, machining centers and conventional machines. The slip-off proof mini clamping nut intRlox® prevents injuries caused by slipping off while tightening the nut. Can be used as extension.

For technical dimensions, please refer to page 56.

CYLF/ERM

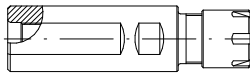

CYLF/ERM The line of cylindrical collet holders with clamping flat is particularly designed for Swiss automatic CNC machines, e.g., Citizen, Manurhin, Star or Tornos. Cannot be used as extension.

For technical dimensions, please refer to page 58.

CYLF/ERMX

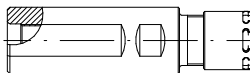

CYLF/ERMX The line of cylindrical collet holders with clamping flat is particularly designed for Swiss automatic CNC machines, e.g., Citizen, Manurhin, Star or Tornos. The slip-off proof mini clamping nut intRlox® prevents injuries caused by slipping off while tightening the nut. Cannot be used as extension.

For technical dimensions, please refer to page 58.

CYL/ER NC

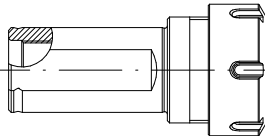

CYL/ER NC These collet holders are particularly suitable on Swiss automatic CNC turning machines, but can also be used on other turning machines.

For technical dimensions, please refer to page 61.

CYDF/ERM

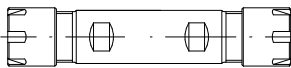

CYDF/ERM The line of double collet holders with clamping flat has been designed for Swiss automatic CNC machines, e.g., Citizen, Manurhin, Star or Tornos and offers the possibility to hold two cutting tools on the same collet holder.

For technical dimensions, please refer to page 62.

CYDF/ERMX

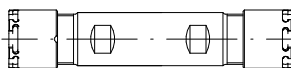

CYDF/ERMX The line of double collet holders with clamping flat has been designed for Swiss Automatic CNC machines, e.g., Citizen, Manurhin, Star or Tornos, and offers the possibility to hold two cutting tools on the same collet holder. The slip-off proof mini clamping nut intRlox® prevents injuries caused by slipping off while tightening the nut.

For technical dimensions, please refer to page 62.

Type	Part no.	Dimensions [mm]						Accessory	
		D	D1 h6	L	L1	G1	G2	Wrench	
CYL 1/2 [inch]									
CYL 1/2" x 070 / ER 11	2613.11141	19	12.7	70	28.5	M 6	–	7112.11010	
CYL 1/2" x 100 / ER 16	2613.11661	28	12.7	100	36	M 6	–	7112.16010	
CYL 1/2" x 100 / ER 20	2613.12061	34	12.7	100	44.5	M 6	–	7112.20010	
CYL 14 [mm]									
CYL 14 x 060 / ER 16	2614.11630	28	14	60	36.5	M 6	–	7112.16010	
CYL 16 [mm]									
CYL 16 x 060 / ER 16	2616.11630	28	16	60	36.5	M 8 x 1	–	7112.20010	
CYL 5/8 [inch]									
CYL 5/8" x 060 / ER 16	2616.11631	28	15.875	60	36.5	M 8 x 1	–	7112.16010	
CYL 5/8" x 100 / ER 20	2616.12061	34	15.875	100	44.5	M 8 x 1	–	7112.20010	
CYL 3/4 [inch]									
CYL 3/4" x 050 / ER 16	2619.11621	28	19.05	50	30.5	M 12 x 1	–	7112.16010	
CYL 3/4" x 100 / ER 16	2619.11661	28	19.05	100	30.5	M 11 x 1	M 12 x 1	7112.16010	
CYL 3/4" x 060 / ER 20	2619.12031	34	19.05	60	36.5	M 12 x 1	–	7112.20010	
CYL 3/4" x 050 / ER 25	2619.12521	42	19.05	50	47	M 12 x 1	–	7111.25000	
CYL 20 [mm]									
CYL 20 x 050 / ER 16	2620.11620	28	20	50	30.5	M 12 x 1	–	7112.16010	
CYL 20 x 100 / ER 16	2620.11660	28	20	100	30.5	M 11 x 1	M 12 x 1	7112.16010	
CYL 20 x 030 / ER 20	2620.12010	34	20	30	36.5	M 12 x 1	–	7112.20010	
CYL 20 x 060 / ER 20	2620.12030	34	20	60	36.5	M 12 x 1	–	7112.20010	
CYL 20 x 050 / ER 25	2620.12520	42	20	50	47	M 12 x 1	–	7111.25000	
CYL 20 x 100 / ER 25	2620.12560	42	20	100	47	M 12 x 1	–	7111.25000	
CYL 20 x 050 / ER 32	2620.13220	50	20	50	54	M 12 x 1	–	7111.32000	
CYL 20 x 100 / ER 32	2620.13260	50	20	100	54	M 12 x 1	–	7111.32000	
CYL 25 [mm]									
CYL 25 x 050 / ER 25	2625.12520	42	25	50	47	M 18 x 1.5	–	7111.25000	
CYL 25 x 100 / ER 25	2625.12560	42	25	100	47	M 18 x 1.5	–	7111.25000	
CYL 25 x 050 / ER 32	2625.13220	50	25	50	54	M 18 x 1.5	–	7111.32000	
CYL 25 x 050 / ER 40	2625.14020	63	25	50	60	M 18 x 1.5	–	7111.40000	

Included in delivery: Colletholder, Hi-Q® / ER clamping nut and back-up screw. Accessories are not included in delivery.

Type	Part no.	Dimensions [mm]						Accessory
		D	D1 h6	L	L1	G1	G2	Wrench
CYL 1 [inch]								
CYL 1" x 100 / ER 20	2625.12061	34	25.4	100	39.5	M 14 x 1	-	7112.20010
CYL 1" x 050 / ER 25	2625.12521	42	25.4	50	47	M 18 x 1.5	-	7111.25000
CYL 1" x 100 / ER 25	2625.12561	42	25.4	100	47	M 18 x 1.5	-	7111.25000
CYL 1" x 050 / ER 32	2625.13221	50	25.4	50	53	M 18 x 1.5	-	7111.32000
CYL 1" x 050 / ER 40	2625.14021	63	25.4	50	60	M 18 x 1.5	-	7111.40000
CYL 30 [mm]								
CYL 30 x 050 / ER 25	2630.12520	42	30	50	42	M 18 x 1.5	-	7111.25000
CYL 1 1/4 [inch]								
CYL 1 1/4" x 060 / ER 32	2632.13231	50	31.75	60	53	M 22 x 1.5	-	7111.32000

Included in delivery: Colletholder, HI-Q® / ER clamping nut and back-up screw. Accessories are not included in delivery.

Expert advice

For additional technical drawings and details, see the REGO-FIX website at www.rego-fix.com

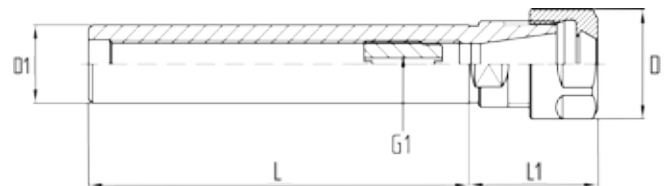

CYL/ER

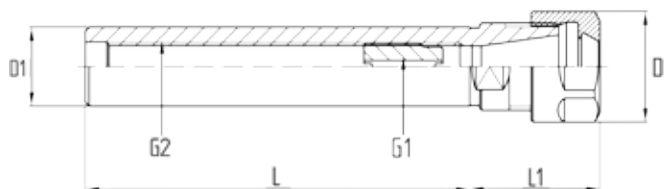

CYL/ER with G2

CYL / ERM colletholders (mini nut)

CYL

CYL / ERMX colletholders with intRlox® (slip-off proof mini nut)

Type	Part no.	Dimensions [mm]				G1	G2	Slip-off proof	Accessory
		D	D1 h6	L	L1				Wrench
CYL 6 [mm]									
CYL 6 x 045 / ERM 11	2606.21120	16	6	45	26.5	–	–	–	7113.11000
CYL 6 x 045 / ERMX 11	4606.21120	16	6	45	26.5	–	–	•	7118.11000
CYL 7 [mm]									
CYL 7 x 045 / ERM 11	2607.21120	16	7	45	26.5	–	–	–	7113.11000
CYL 7 x 045 / ERMX 11	4607.21120	16	7	45	26.5	–	–	•	7118.11000
CYL 8 [mm]									
CYL 8 x 080 / ERM 8	2608.20850	12	8	80	26	M 5	–	–	7113.08000
CYL 8 x 080 / ERMX 8	4608.20850	12	8	80	26	M 5	–	•	7118.08000
CYL 8 x 056 / ERM 11	2608.21130	16	8	56	26.5	M 5	–	–	7113.11000
CYL 3/8 [inch]									
CYL 3/8" x 070 / ERM 8	2609.20841	12	9.525	70	23	M 5	–	–	7113.08000
CYL 3/8" x 070 / ERMX 8	4609.20841	12	9.525	70	23	M 5	–	•	7118.08000
CYL 10 [mm]									
CYL 10 x 060 / ERM 16	2610.21630	22	10	60	38.5	M 5	–	–	7113.16000
CYL 10 x 060 / ERMX 16	4610.21630	22	10	60	38.5	M 5	–	•	7118.16000
CYL 12 [mm]									
CYL 12 x 080 / ERM 8	2612.20850	12	12	80	17	M 5	–	–	7113.08000
CYL 12 x 080 / ERMX 8	4612.20850	12	12	80	17	M 5	–	•	7118.08000
CYL 12 x 080 / ERM 16	2612.21650	22	12	80	38.5	M 5	–	–	7113.16000
CYL 12 x 080 / ERMX 16	4612.21650	22	12	80	38.5	M 5	–	•	7118.16000
CYL 1/2 [inch]									
CYL 1/2" x 140 / ERM 11	2613.21191	16	12.7	140	29.5	M 6	–	–	7113.11000
CYL 1/2" x 140 / ERMX 11	4613.21191	16	12.7	140	29.5	M 6	–	•	7118.11000
CYL 1/2" x 140 / ERM 16	2613.21691	22	12.7	140	37	M 6	–	–	7113.16000
CYL 1/2" x 140 / ERMX 16	4613.21691	22	12.7	140	37	M 6	–	•	7118.16000
CYL 15 [mm]									
CYL 15 x 100 / ERM 20	2615.22060	28	15	100	42.5	M 8 x 1	–	–	7113.20000
CYL 16 [mm]									
CYL 16 x 150 / ERM 11	2616.21190	16	16	150	21	M 8 x 1	–	–	7113.11000
CYL 16 x 150 / ERMX 11	4616.21190	16	16	150	21	M 8 x 1	–	•	7118.11000
CYL 16 x 100 / ERM 20	2616.22060	28	16	100	42.5	M 8 x 1	–	–	7113.20000
CYL 16 x 100 / ERMX 20	4616.22060	28	16	100	42.5	M 8 x 1	–	•	7118.20000

CYL / ERM colletholders (mini nut)

CYL

CYL / ERMX colletholders with intRlox® (slip-off proof mini nut)

Type	Part no.	Dimensions [mm]				G1	G2	Slip-off proof	Accessory Wrench
		D	D1 h6	L	L1				
CYL 5/8 [inch]									
CYL 5/8" x 150 / ERM 11	2616.21191	16	15.875	150	19.5	M 8 x 1	-	-	7113.11000
CYL 5/8" x 150 / ERMX 11	4616.21191	16	15.875	150	19.5	M 8 x 1	-	•	7118.11000
CYL 3/4 [inch]									
CYL 3/4" x 100 / ERM 25	2619.22561	35	19.05	100	47	M 12 x 1	-	-	7113.25000
CYL 3/4" x 100 / ERMX 25	4619.22561	35	19.05	100	47	M 12 x 1	-	•	7118.25000
CYL 3/4" x 155 / ERM 16	2619.21691	22	19.05	155	26.5	M 12 x 1	-	-	7113.16000
CYL 3/4" x 155 / ERMX 16	4619.21691	22	19.05	155	26.5	M 12 x 1	-	•	7118.16000
CYL 20 [mm]									
CYL 20 x 155 / ERM 16	2620.21690	22	20	155	25.5	M 11 x 1	M 12 x 1	-	7113.16000
CYL 20 x 155 / ERMX 16	4620.21690	22	20	155	25.5	M 11 x 1	M 12 x 1	•	7118.16000
CYL 25 [mm]									
CYL 25 x 155 / ERM 20	2625.22090	28	25	155	27	M 14 x 1	-	-	7113.20000
CYL 25 x 155 / ERMX 20	4625.22090	28	25	155	27	M 14 x 1	-	•	7118.20000
CYL 1 [inch]									
CYL 1" x 155 / ERM 20	2625.22091	28	25.4	155	27	M 14 x 1	-	-	7113.20000
CYL 1" x 155 / ERMX 20	4625.22091	28	25.4	155	27	M 14 x 1	-	•	7118.20000

Included in delivery: Colletholder, HI-Q® / ERM or HI-Q® / ERMX clamping nut and back-up screw. Accessories are not included in delivery.

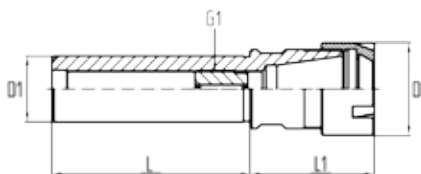

CYL / ERM

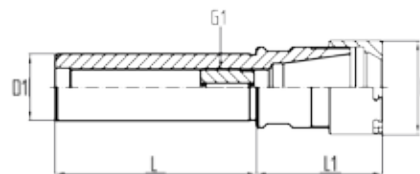

CYL / ERMX

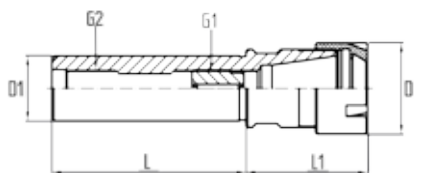

CYL / ERM with G2

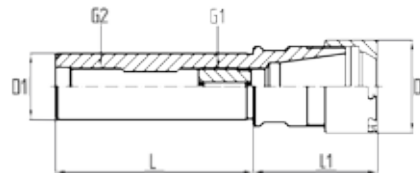

CYL / ERMX with G2

CYLF / ERM colletholders (mini nut)

CYLF

CYLF / ERMX colletholders with intrRlox® (slip-off proof mini nut)

Type	Part no.	Dimensions [mm]					G1	G2	Slip-off proof	Accessory
		D	D1 h6	L	L1	Wrench				
CYLF 12 [mm]										
CYLF 12 x 043 / ERM 8	2612.20822	12	12	43	17	M 5	-	-	7113.08000	
CYLF 12 x 043 / ERMX 8	4612.20822	12	12	43	17	M 5	-	•	7118.08000	
CYLF 5/8 [inch]										
CYLF 5/8" x 043 / ERM 8	2616.20811	12	15.875	43	15.5	M 5	-	-	7113.08000	
CYLF 5/8" x 043 / ERMX 8	4616.20811	12	15.875	43	15.5	M 5	-	•	7118.08000	
CYLF 16 [mm]										
CYLF 16 x 038 / ERM 11	2616.21112	16	16	38	19.5	M 8 x 1	-	-	7113.11000	
CYLF 16 x 038 / ERMX 11	4616.21112	16	16	50	16	M 8 x 1	-	•	7118.11000	
CYLF 16 x 050 / ERM 11	2616.21122	16	16	50	16	M 8 x 1	-	-	7113.11000	
CYLF 16 x 050 / ERMX 11	4616.21122	16	16	50	16	M 8 x 1	-	•	7118.11000	
CYFL 16 x 140 / ERM 11	2616.21192	16	16	140	19.5	M 8 x 1	-	-	7113.11000	
CYFL 16 x 140 / ERMX 11	4616.21192	16	16	140	19.5	M 8 x 1	-	•	7118.11000	
CYLF 16 x 035 / ERM 16	2616.21612	22	16	35	36	M 8 x 1	-	-	7113.16000	
CYLF 16 x 035 / ERMX 16	4616.21612	22	16	35	36	M 8 x 1	-	•	7118.16000	
CYLF 3/4 [inch]										
CYLF 3/4" x 115 / ERM 11	2619.21173	16	19.05	115	19.5	M 8 x 1	-	-	7113.11000	
CYLF 3/4" x 115 / ERMX 11	4619.21173	16	19.05	115	19.5	M 8 x 1	-	•	7118.11000	
CYLF 3/4" x 038 / ERM 16	2619.21613	22	19.05	38	27.5	M 12 x 1	-	-	7113.16000	
CYLF 3/4" x 038 / ERMX 16	4619.21613	22	19.05	38	27.5	M 12 x 1	-	•	7118.16000	
CYLF 3/4" x 050 / ERM 16	2619.21623	22	19.05	50	25	M 12 x 1	-	-	7113.16000	
CYLF 3/4" x 050 / ERMX 16	4619.21623	22	19.05	50	25	M 12 x 1	-	•	7118.16000	
CYLF 3/4" x 070 / ERM 16	2619.21643	22	19.05	70	29.5	M 12 x 1	-	-	7113.16000	
CYLF 3/4" x 070 / ERMX 16	4619.21643	22	19.05	70	29.5	M 12 x 1	-	•	7118.16000	
CYLF 3/4" x 120 / ERM 16	2619.21683	22	19.05	120	27.5	M 11 x 1	M 12 x 1	-	7113.16000	
CYLF 3/4" x 120 / ERMX 16	4619.21683	22	19.05	120	27.5	M 11 x 1	M 12 x 1	•	7118.16000	
CYLF 3/4" x 140 / ERM 16	2619.21693	22	19.05	140	27.5	M 11 x 1	M 12 x 1	-	7113.16000	
CYLF 3/4" x 140 / ERMX 16	4619.21693	22	19.05	140	27.5	M 11 x 1	M 12 x 1	•	7118.16000	
CYLF 3/4" x 155 / ERM 16	2619.21691	22	19.05	155	26.5	M 11 x 1	M 12 x 1	-	7113.16000	
CYLF 3/4" x 155 / ERMX 16	4619.21691	22	19.05	155	26.5	M 11 x 1	M 12 x 1	-	7118.16000	

Included in delivery: Colletholder, HI-Q® / ERM or HI-Q® / ERMX clamping nut and back-up screw. Accessories are not included in delivery.

Expert advice

For additional technical drawings and details, see the REGO-FIX website at www.rego-fix.com

CYLF / ERMX colletholders with intRlox® (slip-off proof mini nut)

Type	Part no.	Dimensions [mm]					G1	G2	Slip-off proof	Accessory
		D	D1 h6	L	L1	Wrench				
CYLF 20 [mm]										
CYLF 20 x 060 / ERM 11	2620.21132	16	20	60	19.5	M 8 x 1	-	-	-	7113.11000
CYLF 20 x 060 / ERMX 11	4620.21132	16	20	60	19.5	M 8 x 1	-	•	-	7118.11000
CYLF 20 x 038 / ERM 16	2620.21612	22	20	38	26.5	M 12 x 1	-	-	-	7113.16000
CYLF 20 x 038 / ERMX 16	4620.21612	22	20	38	26.5	M 12 x 1	-	•	-	7118.16000
CYLF 20 x 050 / ERM 16	2620.21622	22	20	50	27.5	M 12 x 1	-	-	-	7113.16000
CYLF 20 x 050 / ERMX 16	4620.21622	22	20	50	27.5	M 12 x 1	-	•	-	7118.16000
CYLF 20 x 070 / ERM 16	2620.21642	22	20	70	27.5	M 12 x 1	-	-	-	7113.16000
CYLF 20 x 070 / ERMX 16	4620.21642	22	20	70	27.5	M 12 x 1	-	•	-	7118.16000
CYLF 20 x 120 / ERM 16	2620.21682	22	20	120	27.5	M 11 x 1	M 12 x 1	-	-	7113.16000
CYLF 20 x 120 / ERMX 16	4620.21682	22	20	120	27.5	M 11 x 1	M 12 x 1	•	-	7118.16000
CYLF 20 x 140 / ERM 16	2620.21692	22	20	140	27.5	M 11 x 1	M 12 x 1	-	-	7113.16000
CYLF 20 x 140 / ERMX 16	4620.21692	22	20	140	27.5	M 11 x 1	M 12 x 1	•	-	7118.16000
CYLF 22 [mm]										
CYLF 22 x 038 / ERM 16	2622.21612	22	22	38	27.5	M 12 x 1	-	-	-	7113.16000
CYLF 22 x 038 / ERMX 16	4622.21612	22	22	38	27.5	M 12 x 1	-	-	-	7118.16000
CYLF 22 x 070 / ERM 16	2622.21642	22	22	70	27.5	M 12 x 1	-	-	-	7113.16000
CYLF 22 x 070 / ERMX 16	4622.21642	22	22	70	27.5	M 12 x 1	-	-	-	7118.16000
CYLF 22 x 100 / ERM 16	2622.21662	22	22	100	27.5	M 11 x 1	M 12 x 1	-	-	7113.16000
CYLF 22 x 100 / ERMX 16	4622.21662	22	22	100	27.5	M 11 x 1	M 12 x 1	•	-	7118.16000
CYLF 22 x 080 / ERM 20	2622.22052	28	22	80	39	M 12 x 1	-	-	-	7113.20000
CYLF 22 x 080 / ERMX 20	4622.22052	28	22	80	39	M 12 x 1	-	•	-	7118.20000
CYLF 22 x 070 / ERM 25	2622.22542	35	22	70	47	M 12 x 1	-	-	-	7113.25000

Included in delivery: Colletholder, Hi-Q®/ERM or Hi-Q®/ERMX clamping nut and back-up screw. Accessories are not included in delivery.

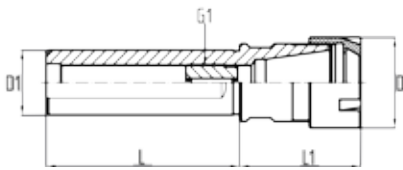

CYLF / ERM

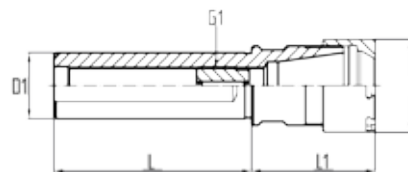

CYLF / ERMX

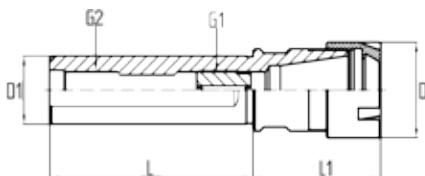

CYLF / ERM with G2

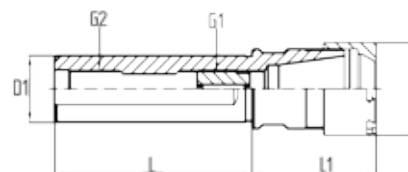

CYLF / ERMX with G2

CYLF / ERM colletholders (mini nut)

CYLF

CYLF / ERMX colletholders with intrRlox® (slip-off proof mini nut)

Type	Part no.	Dimensions [mm]				G1	G2	Slip-off proof	Accessory Wrench
		D	D1 h6	L	L1				
CYLF 25 [mm]									
CYLF 25 x 065 / ERM 16	2625.21642	22	25	65	27.5	M 12 x 1	-	-	7113.16000
CYLF 25 x 065 / ERMX 16	4625.21642	22	25	65	27.5	M 12 x 1	-	•	7118.16000
CYLF 25 x 100 / ERM 20	2625.22062	28	25	100	28	M 14 x 1	-	-	7113.20000
CYLF 25 x 100 / ERMX 20	4625.22062	28	25	100	28	M 14 x 1	-	•	7118.20000
CYLF 25 x 154 / ERM 20	2625.22002	28	25	154	28	M 14 x 1	-	-	7113.20000
CYLF 25 x 154 / ERMX 20	4625.22002	28	25	154	28	M 14 x 1	-	•	7118.20000
CYLF 25 x 075 / ERM 25	2625.22552	35	25	75	47	M 14 x 1	-	-	7113.25000
CYLF 25 x 075 / ERMX 25	4625.22552	35	25	75	47	M 14 x 1	-	•	7118.25000
CYLF 25 x 145 / ERM 25	2625.22592	35	25	145	36	M 14 x 1	-	-	7113.25000
CYLF 25 x 145 / ERMX 25	4625.22592	35	25	145	36	M 14 x 1	-	•	7118.25000
CYLF 1 [inch]									
CYLF 1" x 033 / ERM 16	2625.21613	22	25.4	33	28	M 12 x 1	-	-	7113.16000
CYLF 1" x 033 / ERMX 16	4625.21613	22	25.4	33	28	M 12 x 1	-	•	7118.16000
CYLF 1" x 065 / ERM 16	2625.21643	22	25.4	65	27.5	M 12 x 1	-	-	7113.16000
CYLF 1" x 065 / ERMX 16	4625.21643	22	25.4	65	27.5	M 12 x 1	-	•	7118.16000
CYLF 1" x 075 / ERM 16	2625.21653	22	25.4	75	27.5	M 12 x 1	-	-	7113.16000
CYLF 1" x 075 / ERMX 16	4625.21653	22	25.4	75	27.5	M 12 x 1	-	•	7118.16000
CYLF 1" x 100 / ERM 16	2625.21663	22	25.4	100	27.5	M 11 x 1	M 12 x 1	-	7113.16000
CYLF 1" x 100 / ERMX 16	4625.21663	22	25.4	100	27.5	M 11 x 1	M 12 x 1	•	7118.16000
CYLF 1" x 100 / ERM 20	2625.22063	28	25.4	100	27.5	M 14 x 1	-	-	7113.20000
CYLF 1" x 100 / ERMX 20	4625.22063	28	25.4	100	27.5	M 14 x 1	-	•	7118.20000
CYLF 1" x 140 / ERM 20	2625.22093	28	25.4	140	27.5	M 14 x 1	-	-	7113.20000
CYLF 1" x 140 / ERMX 20	4625.22093	28	25.4	140	27.5	M 14 x 1	-	•	7118.20000
CYLF 32 [mm]									
CYLF 32 x 070 / ERM 25	2632.22542	35	32	70	30	M 18 x 1.5	-	-	7113.25000
CYLF 32 x 070 / ERMX 25	4632.22542	35	32	70	30	M 18 x 1.5	-	•	7118.25000

Included in delivery: Colletholder, Hi-Q® / ERM or Hi-Q® / ERMX clamping nut and back-up screw. Accessories are not included in delivery.

For holders with G2 threading, see page 59 for drawings.

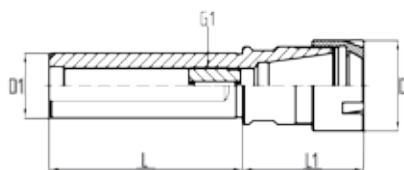

CYLF / ERM

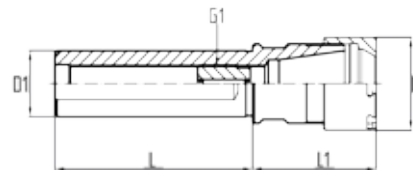

CYLF / ERMX

Type	Part no.	Dimensions [mm]					Accessory	
		D	D1 h6	L	L1	G	Wrench	
CYL 1 1/4 [inch]								
CYL 1 1/4" x 060 / ER NC 25	2632.12533	42	31.75	60	32	M 18 x 1.5	7111.25000	
CYL 1 1/4" x 060 / ER NC 32	2632.13233	50	31.75	60	38	M 22 x 1.5	7111.32000	
CYL 32 [mm]								
CYL 32 x 060 / ER NC 25	2632.12532	42	32	60	32	M 18 x 1.5	7111.25000	
CYL 32 x 060 / ER NC 32	2632.13232	50	32	60	38	M 22 x 1.5	7111.32000	
CYL 1 1/2 [inch]								
CYL 1 1/2" x 080 / ER NC 32	2638.13253	50	38.1	80	33	M 22 x 1.5	7111.32000	
CYL 1 1/2" x 075 / ER NC 40	2638.14053	63	38.1	75	55	M 22 x 1.5	7111.40000	
CYL 40 [mm]								
CYL 40 x 080 / ER NC 32	2640.13252	50	40	80	39	M 22 x 1.5	7111.32000	
CYL 40 x 070 / ER NC 40	2640.14052	63	40	70	55	M 22 x 1.5	7111.40000	

Included in delivery: Colletholder, Hi-Q® / ER clamping nut and backup screw. Accessories are not included in delivery.



CYL / ER NC

Expert advice

For additional technical drawings and details, see the REGO-FIX website at www.rego-fix.com

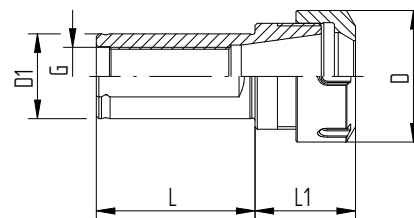

CYL / ER NC

CYDF/ERM colletholders (mini nut)

CYDF

CYDF / ERMX colletholders with intrRlox® (slip-off proof mini nut)

Type	Part no.	Dimensions [mm]					Slip-off proof	Accessory Wrench
		D	D1 h6	L	L1	G		
CYDF 12 [mm]								
CYDF 12 x 015 / ERM 8	2612.20804	12	12	15	46	–	–	7113.08000
CYDF 12 x 015 / ERMX 8	4612.20804	12	12	15	46	–	•	7118.08000
CYDF 12 x 025 / ERM 8	2612.20814	12	12	25	56	–	–	7113.08000
CYDF 12 x 025 / ERMX 8	4612.20814	12	12	25	56	–	•	7118.08000
CYDF 5/8 [inch]								
CYDF 5/8" x 015 / ERM 8	2616.20805	12	15.875	15	46	–	–	7113.08000
CYDF 5/8" x 025 / ERM 8	2616.20895	12	15.875	25	56	–	–	7113.08000
CYDF 5/8" x 025 / ERMX 8	4616.20895	12	15.875	25	56	–	•	7118.08000
CYDF 16 [mm]								
CYDF 16 x 040 / ERM 11	2616.21114	16	16	40	79	–	–	7113.11000
CYDF 16 x 040 / ERMX 11	4616.21114	16	16	40	79	–	•	7118.11000
CYDF 16 x 050 / ERM 11	2616.21124	16	16	50	89	–	–	7113.11000
CYDF 16 x 050 / ERMX 11	4616.21124	16	16	50	89	–	•	7118.11000
CYDF 3/4 [inch]								
CYDF 3/4" x 040 / ERM 11	2619.21125	16	19.05	40	79	–	–	7113.11000
CYDF 3/4" x 040 / ERMX 11	4619.21125	16	19.05	40	79	–	•	7118.11000
CYDF 3/4" x 070 / ERM 11	2619.21145	16	19.05	70	109	–	–	7113.11000
CYDF 3/4" x 070 / ERMX 11	4619.21145	16	19.05	70	109	–	•	7118.11000
CYDF 3/4" x 090 / ERM 11	2619.21165	16	19.05	90	129	–	–	7113.11000
CYDF 3/4" x 090 / ERMX 11	4619.21165	16	19.05	90	129	–	•	7118.11000
CYDF 3/4" x 055 / ERM 16	2619.21635	22	19.05	55	107	–	–	7113.16000
CYDF 3/4" x 055 / ERMX 16	4619.21635	22	19.05	55	107	–	•	7118.16000
CYDF 20 [mm]								
CYDF 20 x 030 / ERM 11	2620.21114	16	20	30	69	–	–	7113.11000
CYDF 20 x 030 / ERMX 11	4620.21114	16	20	30	69	–	•	7118.11000
CYDF 20 x 050 / ERM 11	2620.21124	16	20	50	89	–	–	7113.11000
CYDF 20 x 050 / ERMX 11	4620.21124	16	20	50	89	–	•	7118.11000
CYDF 20 x 055 / ERM 16	2620.21634	22	20	55	107	–	–	7113.16000
CYDF 20 x 055 / ERMX 16	4620.21634	22	20	55	107	–	•	7118.16000

Included in delivery: Colletholder and two HI-Q®/ERM or HI-Q®/ERMX clamping nuts. Accessories are not included in delivery.

Type	Part no.	Dimensions [mm]					Slip-off proof	Accessory Wrench
		D	D1 h6	L	L1	G		
CYDF 22 [mm]								
CYDF 22 x 150 / ERM 11	2622.21194	16	22	150	189	–	–	7113.11000
CYDF 22 x 040 / ERM 16	2622.21624	22	22	40	80	–	–	7113.16000
CYDF 22 x 055 / ERM 16	2622.21634	22	22	55	110	–	–	7113.16000
CYDF 22 x 055 / ERMX 16	4622.21634	22	22	55	110	–	•	7118.16000
CYDF 22 x 075 / ERM 16	2622.21654	22	22	75	130	–	–	7113.16000
CYDF 22 x 075 / ERMX 16	4622.21654	22	22	75	130	–	•	7118.16000
CYDF 25 [mm]								
CYDF 25 x 062 / ERM 16	2625.21634	22	25	62	117	–	–	7113.16000
CYDF 25 x 062 / ERMX 16	4625.21634	22	25	62	117	–	•	7118.16000
CYDF 1 [inch]								
CYDF 1" x 030 / ERM 16	2625.21615	22	25.4	30	86	–	–	7113.16000
CYDF 1" x 030 / ERMX 16	4625.21615	22	25.4	30	86	–	•	7118.16000
CYDF 1" x 062 / ERM 16	2625.21635	22	25.4	62	117	–	–	7113.16000
CYDF 1" x 062 / ERMX 16	4625.21635	22	25.4	62	117	–	•	7118.16000
CYDF 32 [mm]								
CYDF 32 x 055 / ERM 20	2632.22034	28	32	55	110	–	–	7113.20000
CYDF 32 x 055 / ERMX 20	4632.22034	28	32	55	110	–	•	7118.20000
CYDF 32 x 075 / ERM 20	2632.22054	28	32	75	130	–	–	7113.20000
CYDF 32 x 075 / ERMX 20	4632.22054	28	32	75	130	–	•	7118.20000

Included in delivery: Colletholder and two Hi-Q® / ERM or Hi-Q® / ERMX clamping nuts. Accessories are not included in delivery.

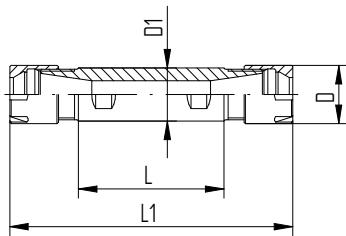

CYDF / ERM

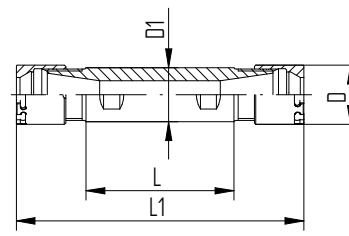

CYDF / ERMX

Morse taper collets holders MK



Applications Morse taper collets holders are designed for drawbar thread application. They can be used on milling or combined drilling-milling machines as well as on boring machines. For drilling machines we supply the corresponding tangs (ATL) on request.

Special applications When extra high-clamping force is needed, e.g., when tapping with ER-GB, we recommend the use of our friction-bearing clamping nuts Hi-Q®/ERB and Hi-Q®/ERBC.

Matched tooling system for best fit For highest precision and best results the whole system counts. Therefore REGO-FIX components are carefully matched for optimum fit and accuracy. This guarantees the best runout and balance.

For the influence of runout on tool life see the graph page 3.

Expert advice

We recommend tightening the clamping nuts using a torque wrench.

For tightening torque recommendations, please refer to page 163.

Type	Part no.	Dimensions [mm]		G	SW	Accessory
		D	L			Wrench
MK 1						
MK 1 / ER 16 x 041	2701.11600	28	93.5	M 6	17	7112.16010
MK 2						
MK 2 / ER 20 x 049	2702.12000	34	111.5	M 10	22	7112.20010
MK 2 / ER 25 x 052	2702.12500	42	115	M 10	24	7111.25000
MK 2 / ER 32 x 060	2702.13200	50	123	M 10	36	7111.32000
MK 3						
MK 3 / ER 25 x 052	2703.12500	42	132	M 12	24	7111.25000
MK 3 / ER 32 x 070	2703.13200	50	150	M 12	24	7111.32000
MK 4						
MK 4 / ER 32 x 060	2704.13200	50	161.5	M 16	32	7111.32000
MK 4 / ER 40 x 082	2704.14000	63	183	M 16	32	7111.40000
MK 5						
MK 5 / ER 40 x 064	2705.14000	63	192	M 20	45	7111.40000
MK 5 / ER 50 x 086	2705.15900	78	214	M 20	45	7111.50000

Included in delivery: Colletholder, Hi-Q® / ER clamping nut and back-up screw. Accessories are not included in delivery.

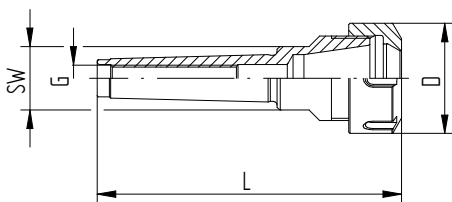

MK / ER

Expert advice

We also offer tangs for use with morse taper MK colletholders.

For tang part numbers, please refer to page 154.

Automotive shank colletholders SH



Applications Automotive shank colletholders with trapezoidal thread are supplied with a setting nut. With this type of colletholder, ER, ER-GB and PCM ET1 collets can be used.

Special applications A quick-change setting nut according to system BILZ is available as an option. This option must be ordered separately. When extra high clamping force is needed, e.g., when tapping with ER-GB, we recommend the use of our friction-bearing clamping nuts Hi-Q® / ERB and Hi-Q® / ERBC.

Matched tooling system for best fit For highest precision and best results the whole system counts. Therefore REGO-FIX components are carefully matched for optimum fit and accuracy. This guarantees the best runout and balance. *For the influence of runout on tool life see the graph on page 3.*

Expert advice

We recommend tightening the clamping nuts using a torque wrench.

For tightening torque recommendations, please refer to page 163.

Type	Part no.	Dimensions [mm]			G	G1	SW	Accessory
		D	L1	L2				Wrench
SH 12								
SH 12 x 050 / ER 11	2612.11104	19	50	46.6	Tr 12 x 1.5	M 5	12	7112.11010
SH 16								
SH 16 x 073 / ER 16	2616.11604	28	73	53.5	Tr 16 x 1.5	M 6	19	7112.16010
SH 20								
SH 20 x 076 / ER 20	2620.12004	34	76	59.5	Tr 20 x 2	M 8	22	7112.20010
SH 28								
SH 28 x 083 / ER 25	2628.12504	42	83	57	Tr 28 x 2	M 18 x 2	28	7111.25000

Included in delivery: Collet holder, HI-Q® / ER clamping nut, back-up screw, setting nut and woodruff-key. Accessories are not included in delivery.

Save time with our quick-change setting nut.

Type	Part no.	Dimensions [mm]			G
		D	D1	L	
Quick-change setting nut (System BILZ)					
SSM 12	7238.12000	22	16.4	18	Tr 12 x 1.5
SSM 16	7238.16000	26	19.9	18.5	Tr 16 x 1.5
SSM 20	7238.20000	33	25.4	20	Tr 20 x 2
SSM 28	7238.28000	42	33.9	22	Tr 28 x 2

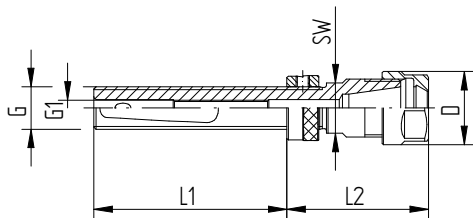

SH/ER

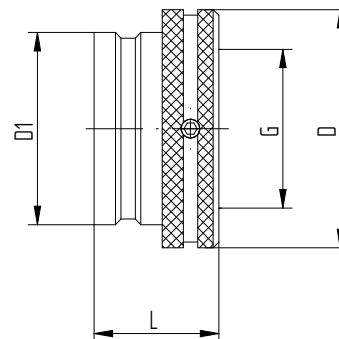

SSM

ISO 20 colletholders



Applications The REGO-FIX ISO 20 collets are designed to work with the HAAS Office Mill. To utilize the full potential of your machine, use the REGO-FIX brand of holders and collets to see the difference quality can achieve in your machining operations.

Balancing

// 100 % balanced to G 2.5 @ 40,000 rpm.

Matched tooling system for best fit For highest precision and best results the whole system counts. Therefore REGO-FIX components are carefully matched for optimum fit and accuracy. This guarantees the best runout and balance.

For the influence of runout on tool life see the graph on page 3.

Expert advice

We recommend tightening the clamping nuts using a torque wrench.

For tightening torque recommendations, please refer to page 163.

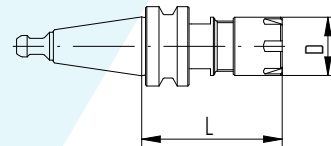

ISO / ERM HAAS

Type	Part no.	Dimensions [mm]		Accessory
		D	L	Wrench
ISO 20				
ISO 20 / ERM 11 x 048 HAAS	2420.11116	16	48	7113.11000
ISO 20 / ERM 16 x 053 HAAS	2420.11616	22	53	7113.16000
ISO 20 / ERM 20 x 055 HAAS	2420.12016	28	55	7113.20000

Included in delivery: ISO colletholder with Hi-Q®/ERM mini clamping nut and integral pull stud.

Accessories are not included in delivery.



ER thread-cutting solutions

CYL SSY / HSK-A SSY Softsynchro® tapping holder

- // With minimum length compensation
- // Eliminates small synchronization errors of machines

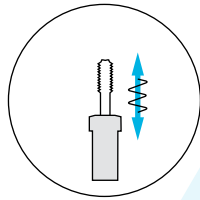

Applications

- // Machines for direct thread cutting
- // For all tapping tools with h9 shanks
- // The turning movement of the spindles can be offset with the feed axis and thus synchronized
- // Synchronization errors are created by the dynamics of the spindle and linear drives. The tapping holder is equipped with the minimum length compensation and compensates the synchronization errors
- // Guides coolant with up to 50 bar of pressure (725 psi) to the tap, without compromising length compensation
- // Depending on the application, the service life for the customer can be increased by up to 150 %

CYL GSF tapping holder

- // With length compensation
- // For machines without a tapping option

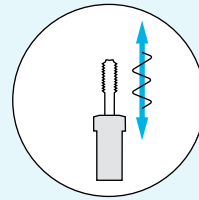

Applications

- // Used on machines in which the feed movement is not synchronized with the thread pitch during processing
- // Ensures the compensation of differences between the thread pitch and spindle feed
- // Features a pressure-point mechanism
- // Safe tap cutting
- // Uniform, reproducible thread depths
- // Guides coolant with up to 50 bar of pressure (725 psi) to the tap, without compromising length compensation
- // Universal use thanks to its compact design and low gauge length

Comparative axial force testing

Occurring axial forces with thread forms M10 in St37. Speed 500 rpm
Source: In-house testing

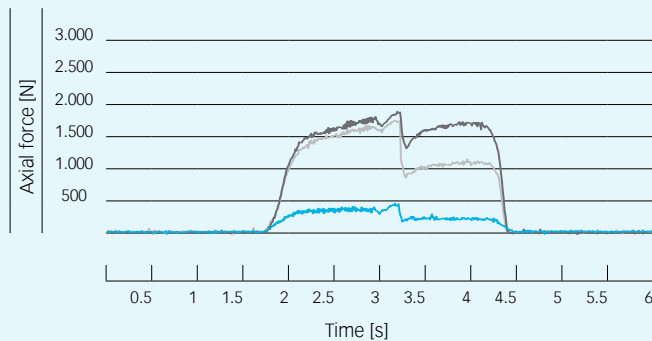

Summary The axial forces increase with increasing speed. With a rigid collet holder, the forces occurring when forming threads are considerably higher than with the Softsynchro® tapping holder. This allows for the optimum use of the synchronous spindle with the best possible service life and thread surface quality.

Comparative axial force testing

Occurring axial forces with thread forms M10 in St37. Speed 2,000 rpm
Source: In-house testing

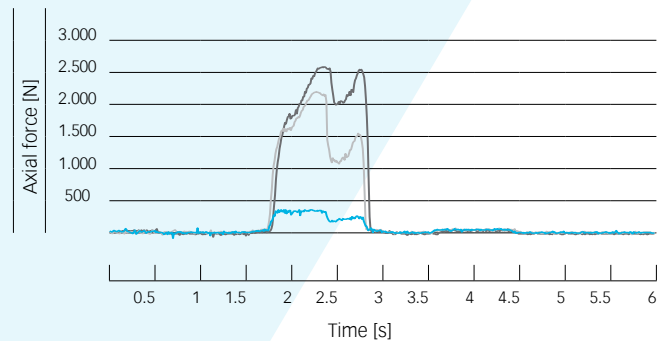

- REGO-FIX Softsynchro® tapping holders
- Competitor synchronous collet holder
- Rigid synchronous collet holder

ER tapping holders

HSK-A SSY

CYL SSY

CYL GSF

69893-A

DIN 1835 B+E

DIN 1835 B+E

ISO 12164

Type	Part no.	Dimensions [mm]		Compression	Tension	SW	Accessory
		D	L	[mm]	[mm]		Wrench
HSK-A 63 SSY							
HSK-A 63 SSY / ERC 20	2563.62000	34	95.5	0.5	0.5	19	7112.20010
HSK-A 63 SSY / ERC 32	2563.63200	50	108.8	0.5	0.5	32	7111.32000

Included in delivery: Tapping holder with Hi-Q®/ERC clamping nut.

Type	Part no.	Dimensions [mm]				Compression	Tension	SW	Accessory
		D	D1	L	L1	[mm]	[mm]		Wrench
CYL 25 SSY									
CYL 25 SSY / ERC 20	2625.62000	34	25	73	57	0.5	0.5	19	7112.20010
CYL 25 SSY / ERC 32	2625.63200	50	25	87.5	57	0.5	0.5	32	7111.32000

Included in delivery: Tapping holder with Hi-Q®/ERC clamping nut.

Type	Part no.	Dimensions [mm]				Compression	Tension	SW	Accessory
		D	D1	L	L1	[mm]	[mm]		Wrench
CYL 25 GSF									
CYL 25 GSF / ERMC 20	2625.62001	28	25	85	57	5	7.5	28	7113.20000
CYL 25 GSF / ERC 32	2625.63201	50	25	115	57	7	10	34	7111.32000

Included in delivery: Tapping holder with Hi-Q®/ERC or Hi-Q®/ERMC clamping nut.

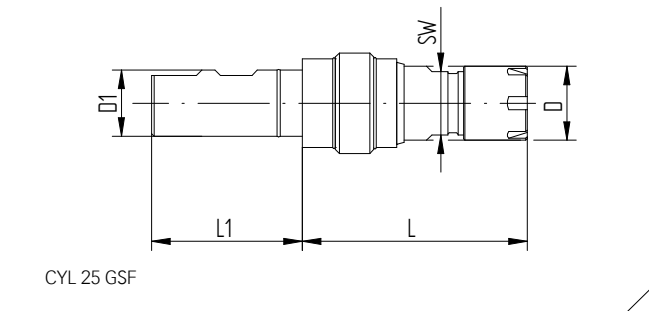
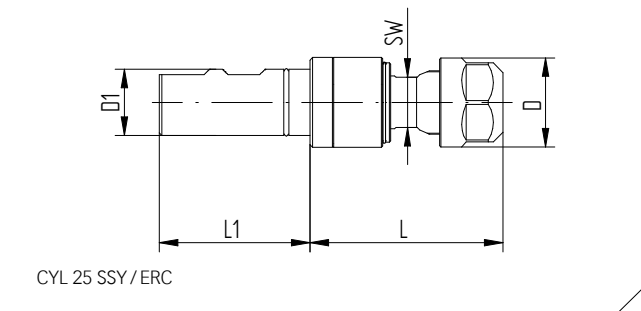
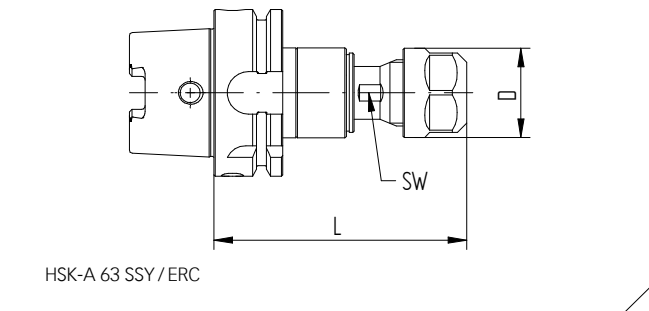

ER floating chucks

When using reamers on lathes it is often necessary to compensate for axis error between the chuck and the bore to be machined. This error can be corrected by using a self-centering floating chuck.

PH / PHC / PHC-C / MPH

Features and benefits

Adjustable floating resistance

Continuously adjustable between auto-centering and free-floating. No restriction of the floating movement.

Adjustment for tool weight

Optimal setup by adjustment of floating resistance is possible.

Vertical and horizontal application

Adjustable self-centering keeps the tool at the center of the floating chuck, even in the horizontal position. Prevents chatter marks and extends tool life.

Combined ball- and friction-bearing

Combined ball and friction-bearing for easy floating:

- // Ball bearing for smooth reaming at low load applications
- // Friction-bearing to withstand high pressures at high load applications

Double sealing against dirt

Prevents coolant and chips from entering the floating chuck.

Excellent bore quality

Only parallel floatation of tool possible.

Floating chuck PH / ER

Features REGO-FIX floating chucks are excellent tools for reaming and tapping:

- // They are specially designed so the tool is self-centering in a vertical and horizontal position
- // The self-centering feature allows very precise positioning of the reaming or tapping tool. This is especially important in horizontal applications, where on ordinary floating chucks the weight of the tool tends to dislocate the tool from the rotational axis
- // The float is always parallel to the rotational axis and the rotation is both clockwise and counter clockwise

Floating chuck PHC / ER for coolant through tools

Features Floating chucks PHC / ER for coolant through tools are especially designed for internal cooling and have the same advantages as the PH / ER floating chucks.

Floating chuck PHC-C / ER REGO-FIX CAPTO

Features These REGO-FIX CAPTO floating chucks are manufactured with polygon interface – licensed by Sandvik Coromant.

Floating chuck MPH / ERMX for tight spaces

Application REGO-FIX MPH / ERMX floating chucks are an efficient solution for tight space applications.

Type	Part no.	Dimensions [mm]						Accessory
		D	D1 h6	D2	L	L1	G	Wrench
PH 5/8 [inch]								
PH 5/8" / ER 11	2616.91102	22	15.88	38	36	34	0.8	7117.11000
PH 16 [mm]								
PH 16/ER 11	2616.91100	22	16	38	36	34	0.8	7117.11000
PH 3/4 [inch]								
PH 3/4" / ER 11	2619.91102	22	19.05	38	36	34	0.8	7117.11000
PH 20 [mm]								
PH 20/ER 11	2620.91100	22	20	38	36	34	0.8	7117.11000
PH 22 [mm]								
PH 22/ER 11	2622.91100	22	22	38	36	34	0.8	7117.11000

Included in delivery: Floating holder, Hi-Q®/ER clamping nut and wrench.



Expert advice

For additional technical drawings and details, see the REGO-FIX website at www.rego-fix.com

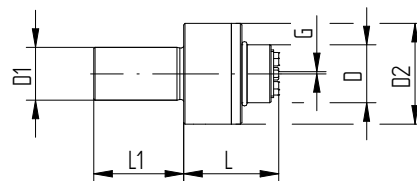

PH/ER

PHC floating chucks for coolant through tools

PHC

Type	Part no.	Dimensions [mm]						Accessory
		D	D1 h6	D2	L	L1	G	Wrench
PHC 5/8 [inch]								
PHC 5/8" / ER 20	2616.92004	33	15.88	56	53.5	38	1	7117.20000
PHC 16								
PHC 16 / ER 20	2616.92003	33	16	56	53.5	38	1	7117.20000
PHC 3/4 [inch]								
PHC 3/4" / ER 20	2619.92004	33	19.05	56	53.5	38	1	7117.20000
PHC 3/4" / ER 32	2619.93204	46	19.05	70	64.5	46	1.5	7117.32000
PHC 20 [mm]								
PHC 20 / ER 20	2620.92003	33	20	56	53.5	38	1	7117.20000
PHC 20 / ER 32	2620.93203	46	20	70	64.5	46	1.5	7117.32000
PHC 22 [mm]								
PHC 22 / ER 20	2622.92003	33	22	56	53.5	38	1	7117.20000
PHC 22 / ER 32	2622.93203	46	22	70	64.5	46	1.5	7117.32000
PHC 25 [mm]								
PHC 25 / ER 20	2625.92003	33	25	56	53.5	38	1	7117.20000
PHC 25 / ER 32	2625.93203	46	25	70	64.5	46	1.5	7117.32000
PHC 1 [inch]								
PHC 1" / ER 20	2625.92004	33	25.4	56	53.5	38	1	7117.20000
PHC 1" / ER 32	2625.93204	46	25.4	70	64.5	46	1.5	7117.32000
PHC 1 1/4 [inch]								
PHC 1 1/4" / ER 32	2632.93204	46	31.75	70	64.5	46	1.5	7117.20000
PHC 32 [mm]								
PHC 32 / ER 32	2632.93203	46	32	70	64.5	46	1.5	7117.20000
PHC 1 3/4 [inch]								
PHC 1 3/4" / ER 32	2644.93204	46	44.45	70	64.5	46	1.5	7117.20000

Included in delivery: Floating holder, Hi-Q®/ERAX clamping nut, wrench and adjusting key.

Expert advice

When using coolant through tools please order Hi-Q®/ERAXC clamping nuts and the corresponding sealing disks.

PHC-C floating chucks for coolant through tools with REGO-FIX CAPTO interface

PHC-C

Type	Part no.	Dimensions [mm]					Accessory
		D	D2	L	L1	G	Wrench
PHC-C3							
PHC-C3 / ER 20	2803.92003	33	56	91	53.5	0.8	7117.20000
PHC-C4							
PHC-C4 / ER 20	2804.92003	33	56	91	56.5	0.8	7117.20000
PHC-C4 / ER 32	2804.93203	46	70	100	64	0.8	7117.32000

Included in delivery: Floating holder, Hi-Q®/ERAX clamping nut and wrench.

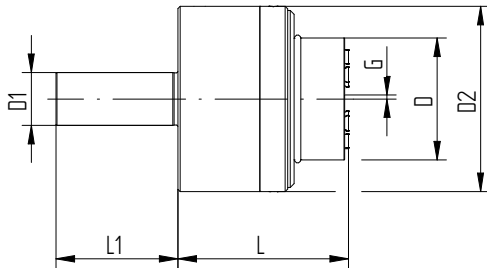

PHC / ER

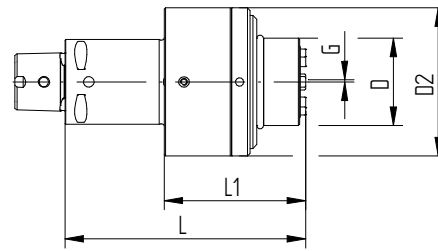

PHC-C / ER

Certified REGO-FIX CAPTO – licensed by Sandvik Coromant – is manufactured at REGO-FIX Switzerland under license according to CAPTO specifications.

MPH mini floating chucks with intrRlox® (slip-off proof mini nut)

MPH

1.3 ER floating chucks

Type	Part no.	Dimensions [mm]						Accessory	
		D	D1 h6	D2	L	L1	G	Wrench	
MPH 8 [mm]									
MPH 8 / ERMX 11	4608.91107	16	8	25	35.5	42	0.5	7118.11000	
MPH 10 [mm]									
MPH 10 / ERMX 11	4610.91107	16	10	25	35.5	42	0.5	7118.11000	
MPH 16 [mm]									
MPH 16 / ERMX 11	4616.91107	16	16	25	35.5	42	0.5	7118.11000	
MPH 3/4"									
MPH 3/4" / ERMX 11	4619.91108	16	19.05	25	35.5	70	0.5	7118.11000	
MPH 20 [mm]									
MPH 20 / ERMX 11	4620.91107	16	20	25	35.5	42	0.5	7118.11000	
MPH 22 [mm]									
MPH 22 / ERMX 11	4622.91107	16	22	25	35.5	42	0.5	7118.11000	
MPH 25 [mm]									
MPH 25 / ERMX 11	4625.91107	16	25	25	35.5	42	0.5	7118.11000	
MPH 1 [inch]									
MPH 1" / ERMX 11	4625.91108	16	25.4	25	35.5	42	0.5	7118.11000	

Included in delivery: Floating holder, Hi-Q®/ERMX clamping nut and wrench.

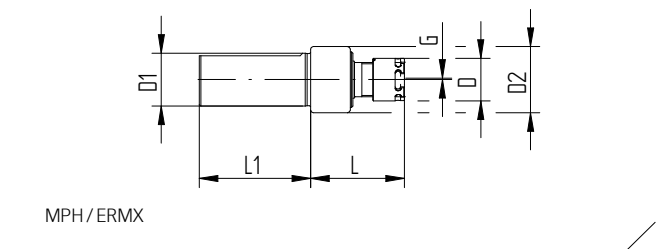

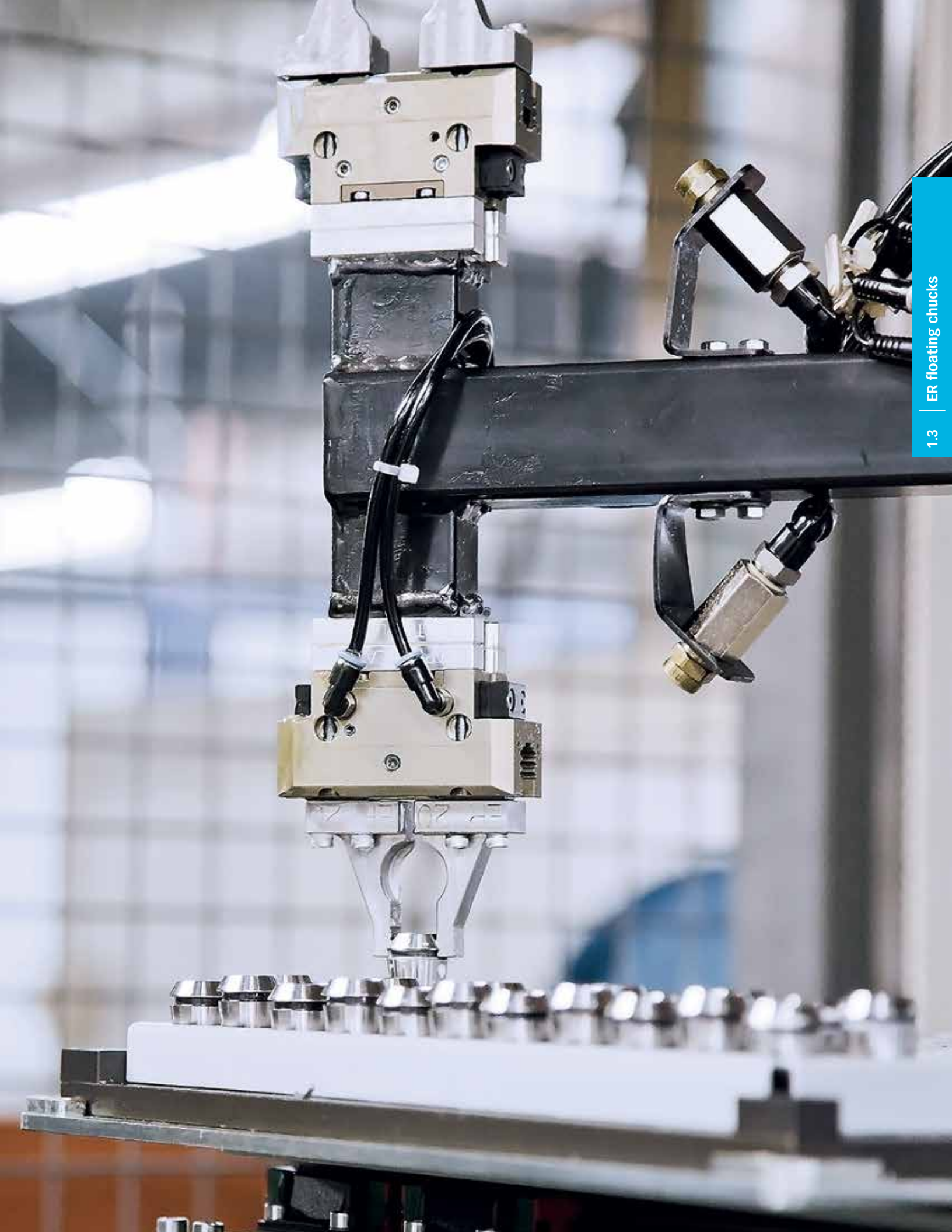

Collet reductions



ER/ERM ERM/ERM ER/ERMX ERMX/ERMX

Features and benefits

Surface finish max. Ra 0.25

Higher clamping force and higher transferable torque.

Applications

The collet reductions are mainly used on Swiss machines with live tooling.

Quick change system

Best suited for quick tool change as the cutting tools can be preinstalled.

Length presetting

Tools can be preset outside of the machine.

Minimal external dimensions

Achieve minimal external dimensions by using Hi-Q®/ERM or Hi-Q®/ERMX clamping nuts.

Expert advice

We recommend tightening the clamping nuts using a torque wrench.

For tightening torque recommendations, please refer to page 163.

Type	Part no.	Dimensions [mm]				Accessory Wrenches
		D	D1	L	L1	
ER 11						
ER 11 / ERM 8	7162.11080	12	19	33	16.5	7112.11010 / 7113.08000
ER 16						
ER 16 / ERM 11	7162.16110	16	28	42.5	18.5	7112.16010 / 7113.11000
ER 20						
ER 20 / ERM 11	7162.20110	16	34	42	16.5	7112.20010 / 7113.11000
ER 20 / ERM 16	7162.20160	22	34	55.5	28	7112.20010 / 7113.16000
ER 25						
ER 25 / ERM 11	7162.25110	16	42	54.5	16.5	7111.25000 / 7113.11000
ER 25 / ERM 16	7162.25160	22	42	60.5	28	7111.25000 / 7113.16000
ER 25 / ERM 20	7162.25200	28	42	60.5	28	7111.25000 / 7113.20000
ER 32						
ER 32 / ER 16	7160.32160	28	50	56	29.5	7111.32000 / 7112.16010
ER 32 / ER 20	7160.32200	34	50	69.5	32.5	7111.32000 / 7112.20010
ERM 11						
ERM 11 / ERM 8	7161.11080	12	16	33	16.5	7113.11000 / 7113.08000
ERM 16						
ERM 16 / ERM 11	7161.16110	16	23	42.5	18.5	7113.16000 / 7113.11000
ERM 20						
ERM 20 / ERM 16	7161.20160	22	28	55.5	28	7113.20000 / 7113.16000
ERM 25						
ERM 25 / ERM 11	7161.25110	16	35	54.5	22	7113.25000 / 7113.11000
ERM 25 / ERM 16	7161.25160	22	35	60.5	28	7113.25000 / 7113.16000
ERM 25 / ERM 20	7161.25200	28	35	60.5	28	7113.25000 / 7113.20000

Accessories are not included in delivery.

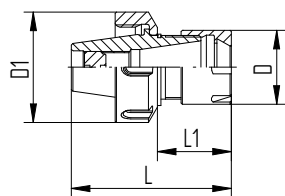

ER / ERM

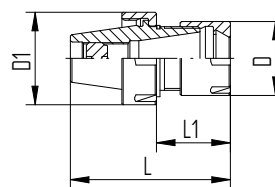

ERM / ERM

Type	Part no.	Dimensions [mm]				Accessory
		D	D1	L	L1	Wrenches
ER 11						
ER 11/ERMX 8	7165.11080	12	19	33	16.5	7112.11010/7118.08000
ER 16						
ER 16/ERMX 11	7165.16110	16	28	42.5	18.5	7112.16010/7118.11000
ER 20						
ER 20/ERMX 11	7165.20110	16	34	42	16.5	7112.20010/7118.11000
ER 20/ERMX 16	7165.20160	22	34	55.5	28	7112.20010/7118.16000
ER 25						
ER 25/ERMX 11	7165.25110	16	42	54.5	16.5	7111.25000/7118.11000
ER 25/ERMX 16	7165.25160	22	42	60.5	28	7111.25000/7118.16000
ER 25/ERMX 20	7165.25200	28	42	60.5	28	7111.25000/7118.20000
ERMX 11						
ERMX 11/ERMX 8	7164.11080	12	16	33	16.5	7118.11000/7118.08000
ERMX 16						
ERMX 16/ERMX 11	7164.16110	16	23	42.5	18.5	7118.16000/7118.11000
ERMX 20						
ERMX 20/ERMX 16	7164.20160	22	28	55.5	28	7118.20000/7118.16000
ERMX 25						
ERMX 25/ERMX 11	7164.25110	16	35	54.5	22	7118.25000/7118.11000
ERMX 25/ERMX 16	7164.25160	22	35	60.5	28	7118.25000/7118.16000

Accessories are not included in delivery.

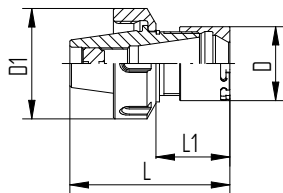



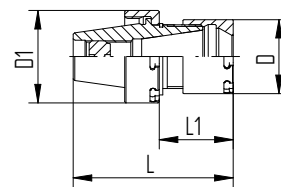



ER / ERMX



ERMX / ERMX



Micro-machining	Standard and ultraprecision	Metallic sealed	Pullout protection secuRgrip®	Collets for tapping	
ER-MB	ER standard/ ER-UP	ER-DM	ER-SG	ER-GB	PCM ET1
					
page 88	page 89	page 98	page 103	page 104	page 108



Successful clamping since 1972

Combine our ER colletholders with our ER collets to ensure maximum precision and balance to maximize your tool life.

Experience the quality of the triangle The outstanding design paired with our experienced engineering make the ER products one of our most successful toolholding options. What you see is what you get: all our products bear the REGO-FIX triangle – our seal for outstanding Swiss quality.

Runout TIR of ER standard and ER-UP collets

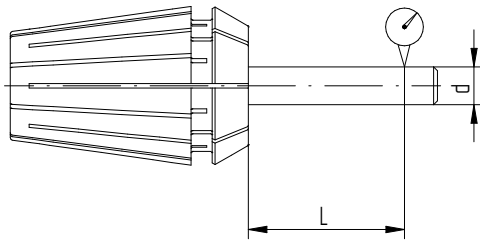

Clamping diameter d [mm]			TIR max. [mm]		
>	≤	L	DIN 6499		
			ISO 15488 B	ΔER std.	ΔER-UP
1	1.6	6	0.015	0.01	0.005
1.6	3	10	0.015	0.01	0.005
3	6	16	0.015	0.01	0.005
6	10	25	0.015	0.01	0.005
10	18	40	0.02	0.01	0.005
18	26	50	0.02	0.01	0.005
26	36	60	0.025	0.01	0.005

Key advantages

Rely on the original

Wide clamping range

The slot design allows for a wide clamping range with a continuing best runout TIR.

Broad range of products

We offer sizes from ER 8 up to ER 50 and diameters from 0.0079" (0.2 mm) up to 1.4173" (36 mm).

Up to 20 % more clamping length

Improve your runout with up to 20 % more clamping length in smaller diameters.

Matched tooling system for best fit

The compatibility of the entire system results in maximum precision, balance and tool life.



Swiss quality standard

Our products marked Swiss made are manufactured at our headquarters in Tenniken, Switzerland.

Swiss quality collets for your production

Our wide product range offers the perfect collet for every application.

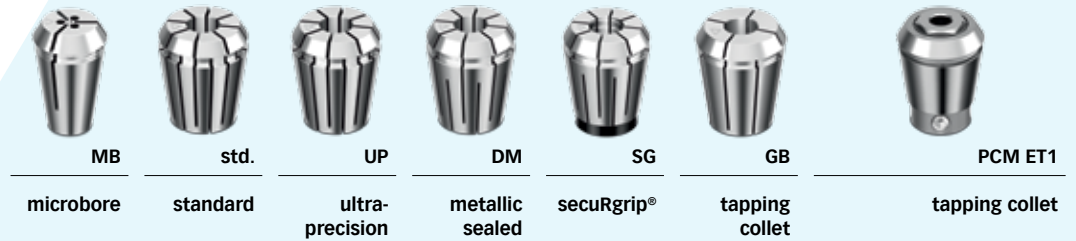

	MB microbore	std. standard	UP ultra-precision	DM metallic sealed	SG secuRgrip®	GB tapping collet	PCM ET1 tapping collet
Main machining use	micro-machining	all	high precision	internal cooling	heavy machining	rigid tapping	rigid tapping with length compensation
DIN ISO 15488: form ...	A	B	B	B	B	A	A
ER size	8–16	8–50	8–50	11–40	32–40	11–50	11–40
Shaft Diameter range (mm)	0.2–0.9	1.0–36.0	1.0–36.0	3.0–26.0	10.0–16.0	2.5–32.0	1.4–17.0
Clamping range (mm) or tolerance	h7	1	1	0.5*	h6	h9	h9
Shaft Diameter range (inch)	0.0079 – 0.0354	0.0425 – 1.4173	0.0425 – 1.4173	0.1250 – 1.000	0.500 – 1.000	0.141 – 1.233	0.141 – 0.697
Clamping range (inch) or tolerance	h7	0.0394	0.0394	0.0197*	h6	h9	h9
Runout (TIR)	0.00024" (6 µm)	0.0004" (10 µm)	0.0002" (5 µm)	0.00024" (6 µm)	0.0002" (5 µm)	0.0004" (10 µm)	0.0004" (10 µm)
Rust protected	–	–	available on request	–	–	–	–
Metallic sealed	–	–	–	•	–	–	–
Internal square	–	–	–	–	–	•	•
Length compensation	–	–	–	–	–	–	•
secuRgrip® thread to prevent tool pullout	–	–	–	–	•	–	–
Collet-locking system	–	•	•	•*	•	•	–
More information on	page 86	page 87	page 87	page 96	page 101	page 102	page 106

* Does not apply for ER-DM collets with counterbore.

Need even better runout? With a total system runout TIR of $\leq 3 \mu\text{m}$, our other system solutions powRgrip® and micRun® achieve even better runout results.

Learn more on page 4 and 5 or on www.rego-fix.com.

Expert advice

Please note that DM collets are not compatible with Weldon or Whistle notch shafts.

To achieve internal cooling with Weldon or Whistle notch shafts, use the REGO-FIX sealing disks ER/DS with your REGO-FIX ER collet.

Finest quality deserves best treatment

Correct assembly increases your collet life and ensures low runout TIR.

Assembly instructions for ER and ER-UP collets

- // Insert collet groove into the eccentric ring of the clamping nut at the mark on the bottom of the nut
- // Push the collet in the direction of the arrow until it clicks in place
- // Screw the nut with the collet onto the colletcher
- // We recommend to tighten the nut with a torque wrench.

For recommended tightening torque please refer to list on page 157.

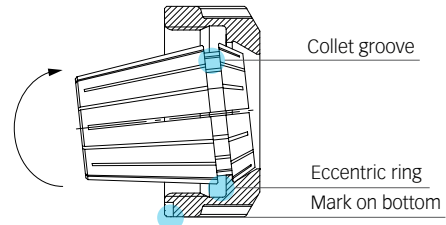

Assembling

Disassembly instructions After the nut is unscrewed from the colletcher, press on the face of the collet while simultaneously pushing sideways on the back of the collet opposite the mark, until it disengages from the clamping nut.

General advice Never clamp oversized tool shanks. For example, never use a Ø 12 mm to 11 mm collet to clamp a Ø 12.2 mm shank. Rather use the next bigger collet (in this case a Ø 12.5 mm – 11.5 mm or 13 mm – 12 mm collet). Insert tool to the full length of the collet for best results if possible.

Also, never insert the tool less than $\frac{2}{3}$ of the collet length. Improper tool insertion can permanently deform the collet and will result in poor runout.

Improper assembly can permanently damage the runout TIR of the collet and may result in the destruction of the clamping nut. Only mount clamping nuts with correctly assembled collets.

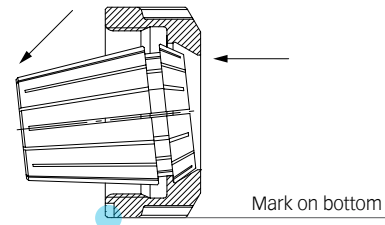

Disassembling

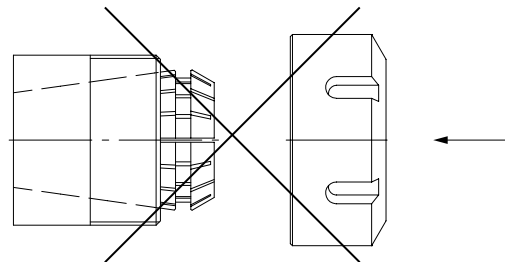

Expert advice

Please only set back-up screw to the tool shank **after** clamping the tool. Disregarding this will result in bad run out and reduced clamping force. This back-up screw only serves as protection against a push-back of the tool and must not be used for presetting.

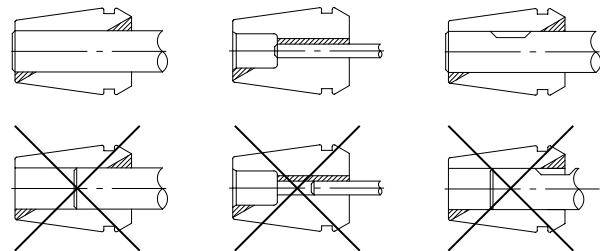

Type	Part no.	Clamping capacity h7	
		[mm]	[inch]
ER 8-MB			
Ø 0.2 mm	1308.00200	0.2	0.0079
Ø 0.3 mm	1308.00300	0.3	0.0118
Ø 0.4 mm	1308.00400	0.4	0.0157
Ø 0.5 mm	1308.00500	0.5	0.0197
Ø 0.6 mm	1308.00600	0.6	0.0236
Ø 0.7 mm	1308.00700	0.7	0.0276
Ø 0.8 mm	1308.00800	0.8	0.0315
Ø 0.9 mm	1308.00900	0.9	0.0354

ER 11-MB			
Ø 0.2 mm	1311.00200	0.2	0.0079
Ø 0.3 mm	1311.00300	0.3	0.0118
Ø 0.4 mm	1311.00400	0.4	0.0157
Ø 0.5 mm	1311.00500	0.5	0.0197
Ø 0.6 mm	1311.00600	0.6	0.0236
Ø 0.7 mm	1311.00700	0.7	0.0276
Ø 0.8 mm	1311.00800	0.8	0.0315
Ø 0.9 mm	1311.00900	0.9	0.0354

ER 16-MB			
Ø 0.2 mm	1316.00200	0.2	0.0079
Ø 0.3 mm	1316.00300	0.3	0.0118
Ø 0.4 mm	1316.00400	0.4	0.0157
Ø 0.5 mm	1316.00500	0.5	0.0197
Ø 0.6 mm	1316.00600	0.6	0.0236
Ø 0.7 mm	1316.00700	0.7	0.0276
Ø 0.8 mm	1316.00800	0.8	0.0315
Ø 0.9 mm	1316.00900	0.9	0.0354

For further technical information, please refer to page 159.

Expert advice

Microbore collets have a runout of $\leq .0002''$ (6 μm). They have been developed by REGO-FIX especially for smallest tool shank diameters.

For tool shanks with nominal diameter h7 tolerance only.



ER 16-MB

ER standard collets and ultraprecision collets ER-UP

ER std.	ER-UP
DIN 6499-B	DIN 6499-B
ISO 15488	ISO 15488

Type	Part no.		Clamping range		Ø [inch]	Included in set
	ER standard	ER-UP	[mm]	[inch]		
ER 8 [mm]						
SET ER 8	1108.00000	1108.00001	0.5–5.0	0.0197–0.1969	–	–
Ø 1.0 mm	1108.01000	1108.01001	1.0–0.5	0.0394–0.0197	1/32"	•
Ø 1.5 mm	1108.01500	1108.01501	1.5–1.0	0.0591–0.0394	–	•
Ø 2.0 mm	1108.02000	1108.02001	2.0–1.5	0.0787–0.0591	–	•
Ø 2.5 mm	1108.02500	1108.02501	2.5–2.0	0.0984–0.0787	3/32"	•
Ø 3.0 mm	1108.03000	1108.03001	3.0–2.5	0.1181–0.0984	–	•
Ø 3.5 mm	1108.03500	1108.03501	3.5–3.0	0.1378–0.1181	–	•
Ø 4.0 mm	1108.04000	1108.04001	4.0–3.5	0.1575–0.1378	5/32"	•
Ø 4.5 mm	1108.04500	1108.04501	4.5–4.0	0.1772–0.1575	–	•
Ø 5.0 mm	1108.05000	1108.05001	5.0–4.5	0.1969–0.1772	–	•
ER 8 [inch]						
INCH SET ER 8	1108.00002	1108.00003	1.09–4.76	0.0429–0.1875	–	–
Ø 1/16"	1108.01592	1108.01593	1.59–1.09	0.0625–0.0429	–	•
Ø 1/8"	1108.03182	1108.03183	3.18–2.68	0.125–0.1055	–	•
Ø 3/16"	1108.04762	1108.04763	4.76–4.25	0.1875–0.1675	–	•
ER 11 [mm]						
SET ER 11	1111.00000	1111.00001	0.5–7.0	0.0197–0.2756	–	–
Ø 1.0 mm	1111.01000	1111.01001	1.0–0.5	0.0394–0.0197	1/32"	•
Ø 1.5 mm	1111.01500	1111.01501	1.5–1.0	0.0591–0.0394	–	•
Ø 2.0 mm	1111.02000	1111.02001	2.0–1.5	0.0787–0.0591	–	•
Ø 2.5 mm	1111.02500	1111.02501	2.5–2.0	0.0984–0.0787	–	•
Ø 3.0 mm	1111.03000	1111.03001	3.0–2.5	0.1181–0.0984	–	•
Ø 3.5 mm	1111.03500	1111.03501	3.5–3.0	0.1378–0.1181	–	•
Ø 4.0 mm	1111.04000	1111.04001	4.0–3.5	0.1575–0.1378	–	•
Ø 4.5 mm	1111.04500	1111.04501	4.5–4.0	0.1772–0.1575	–	•
Ø 5.0 mm	1111.05000	1111.05001	5.0–4.5	0.1969–0.1772	–	•
Ø 5.5 mm	1111.05500	1111.05501	5.5–5.0	0.2165–0.1969	–	•
Ø 6.0 mm	1111.06000	1111.06001	6.0–5.5	0.2362–0.2165	–	•
Ø 6.5 mm	1111.06500	1111.06501	6.5–6.0	0.2559–0.2362	–	•
Ø 7.0 mm	1111.07000	1111.07001	7.0–6.5	0.2756–0.2559	–	•

Included in the ER sets are all marked collets within that size and the matching collet tray ZWT.

For further technical information, please refer to page 158.

* Approx. inch sizing

Expert advice

REGO-FIX ER-UP collets are available with a new rust protection for improved collet lifetime on request.

ER standard collets and ultraprecision collets ER-UP

ER std.	ER-UP
DIN 6499-B	DIN 6499-B
ISO 15488	ISO 15488

Type	Part no.		Clamping range		Ø [inch]	Included in set
	ER standard	ER-UP	[mm]	[inch]		
ER 11 [inch]						
INCH SET ER 11	1111.00002	1111.00003	1.09–6.35	0.0429–0.25	–	–
Ø 1/16"	1111.01592	1111.01593	1.59–1.09	0.0625–0.0429	–	•
Ø 3/32"	1111.02382	1111.02383	2.38–1.87	0.0938–0.0738	–	•
Ø 1/8"	1111.03182	1111.03183	3.18–2.67	0.125–0.105	–	•
Ø 5/32"	1111.03972	1111.03973	3.97–3.46	0.1563–0.1363	–	•
Ø 3/16"	1111.04762	1111.04763	4.76–4.25	0.1875–0.1675	–	•
Ø 7/32"	1111.05562	1111.05563	5.56–5.04	0.2188–0.1988	–	•
Ø 1/4"	1111.06352	1111.06353	6.35–5.84	0.25–0.23	–	•
ER 16 [mm]						
SET ER 16	1116.00000	1116.00001	0.5–10.0	0.0197–0.3937	–	–
Ø 1.0 mm	1116.01000	1116.01001	1.0–0.5	0.0394–0.0197	1/32"	•
Ø 1.5 mm	1116.01500	1116.01501	1.5–1.0	0.0591–0.0394	–	–
Ø 2.0 mm	1116.02000	1116.02001	2.0–1.0	0.0787–0.0394	–	•
Ø 2.5 mm	1116.02500	1116.02501	2.5–1.5	0.0984–0.0591	–	–
Ø 3.0 mm	1116.03000	1116.03001	3.0–2.0	0.1181–0.0787	–	•
Ø 3.5 mm	1116.03500	1116.03501	3.5–2.5	0.1378–0.0984	–	–
Ø 4.0 mm	1116.04000	1116.04001	4.0–3.0	0.1575–0.1181	–	•
Ø 4.5 mm	1116.04500	1116.04501	4.5–3.5	0.1772–0.1378	–	–
Ø 5.0 mm	1116.05000	1116.05001	5.0–4.0	0.1969–0.1575	–	•
Ø 5.5 mm	1116.05500	1116.05501	5.5–4.5	0.2165–0.1772	–	–
Ø 6.0 mm	1116.06000	1116.06001	6.0–5.0	0.2362–0.1969	–	•
Ø 6.5 mm	1116.06500	1116.06501	6.5–5.5	0.2559–0.2165	–	–
Ø 7.0 mm	1116.07000	1116.07001	7.0–6.0	0.2756–0.2362	–	•
Ø 7.5 mm	1116.07500	1116.07501	7.5–6.5	0.2953–0.2559	–	–
Ø 8.0 mm	1116.08000	1116.08001	8.0–7.0	0.315–0.2756	–	•
Ø 8.5 mm	1116.08500	1116.08501	8.5–7.5	0.3346–0.2953	–	–
Ø 9.0 mm	1116.09000	1116.09001	9.0–8.0	0.3543–0.315	–	•
Ø 9.5 mm	1116.09500	1116.09501	9.5–8.5	0.374–0.3346	–	–
Ø 10.0 mm	1116.10000	1116.10001	10.0–9.0	0.3937–0.3543	–	•
ER 16 [inch]						
INCH SET ER 16	1116.00002	1116.00003	1.09–10.32	0.0429–0.4063	–	–
Ø 1/16"	1116.01592	1116.01593	1.59–1.09	0.0625–0.0429	–	•
Ø 3/32"	1116.02382	1116.02383	2.38–1.87	0.0938–0.0738	–	•
Ø 1/8"	1116.03182	1116.03183	3.18–2.16	0.125–0.085	–	•
Ø 5/32"	1116.03972	1116.03973	3.97–2.95	0.1563–0.1163	–	•
Ø 3/16"	1116.04762	1116.04763	4.76–3.75	0.1875–0.1475	–	•

Included in the ER sets are all marked collets within that size and the matching collet tray ZWT.

* Approx. inch sizing

ER standard collets and ultraprecision collets ER-UP

ER std.	ER-UP
DIN 6499-B	DIN 6499-B
ISO 15488	ISO 15488

Type	Part no.		Clamping range		Ø [inch]	Included in set
	ER standard	ER-UP	[mm]	[inch]		
Ø 7/32"	1116.05562	1116.05563	5.56–4.54	0.2188–0.1788	–	•
Ø 1/4"	1116.06352	1116.06353	6.35–5.33	0.25–0.21	–	•
Ø 9/32"	1116.07142	1116.07143	7.15–6.13	0.2813–0.2413	–	•
Ø 5/16"	1116.07942	1116.07943	7.94–6.92	0.3125–0.2725	–	•
Ø 11/32"	1116.08732	1116.08733	8.73–7.72	0.3438–0.3038	–	•
Ø 3/8"	1116.09532	1116.09533	9.53–8.51	0.375–0.335	–	•
Ø 13/32"	1116.10322	1116.10323	10.32–9.3	0.4063–0.3663	–	•

ER 20 [mm]						
SET ER 20	1120.00000	1120.00001	1.0–13.0	0.0394–0.5118	–	–
Ø 1.0 mm	1120.01000	1120.01001	1.0–0.5	0.0394–0.0197	1/32"	–
Ø 1.5 mm	1120.01500	1120.01501	1.5–1.0	0.0591–0.0394	–	–
Ø 2.0 mm	1120.02000	1120.02001	2.0–1.0	0.0787–0.0394	1/16"	•
Ø 2.5 mm	1120.02500	1120.02501	2.5–1.5	0.0984–0.0591	3/32"	–
Ø 3.0 mm	1120.03000	1120.03001	3.0–2.0	0.1181–0.0787	–	•
Ø 3.5 mm	1120.03500	1120.03501	3.5–2.5	0.1378–0.0984	–	–
Ø 4.0 mm	1120.04000	1120.04001	4.0–3.0	0.1575–0.1181	5/32"	•
Ø 4.5 mm	1120.04500	1120.04501	4.5–3.5	0.1772–0.1378	–	–
Ø 5.0 mm	1120.05000	1120.05001	5.0–4.0	0.1969–0.1575	–	•
Ø 5.5 mm	1120.05500	1120.05501	5.5–4.5	0.2165–0.1772	–	–
Ø 6.0 mm	1120.06000	1120.06001	6.0–5.0	0.2362–0.1969	7/32"	•
Ø 6.5 mm	1120.06500	1120.06501	6.5–5.5	0.2559–0.2165	–	–
Ø 7.0 mm	1120.07000	1120.07001	7.0–6.0	0.2756–0.2362	–	•
Ø 7.5 mm	1120.07500	1120.07501	7.5–6.5	0.2953–0.2559	9/32"	–
Ø 8.0 mm	1120.08000	1120.08001	8.0–7.0	0.315–0.2756	–	•
Ø 8.5 mm	1120.08500	1120.08501	8.5–7.5	0.3346–0.2953	–	–
Ø 9.0 mm	1120.09000	1120.09001	9.0–8.0	0.3543–0.315	11/32"	•
Ø 9.5 mm	1120.09500	1120.09501	9.5–8.5	0.374–0.3346	–	–
Ø 10.0 mm	1120.10000	1120.10001	10.0–9.0	0.3937–0.3543	–	•
Ø 10.5 mm	1120.10500	1120.10501	10.5–9.5	0.4134–0.374	13/32"	–
Ø 11.0 mm	1120.11000	1120.11001	11.0–10.0	0.4331–0.3937	–	•
Ø 11.5 mm	1120.11500	1120.11501	11.5–10.5	0.4528–0.4134	–	–
Ø 12.0 mm	1120.12000	1120.12001	12.0–11.0	0.4724–0.433	15/32"	•
Ø 12.5 mm	1120.12500	1120.12501	12.5–11.5	0.4921–0.4528	–	–
Ø 13.0 mm	1120.13000	1120.13001	13.0–12.0	0.5118–0.4724	–	•

Included in the ER sets are all marked collets within that size and the matching collet tray ZWT.

For further technical information, please refer to page 158.

* Approx. inch sizing

Expert advice

REGO-FIX ER-UP collets are available with a new rust protection for improved collet lifetime on request.

ER standard collets and ultraprecision collets ER-UP

ER std.	ER-UP
DIN 6499-B	DIN 6499-B
ISO 15488	ISO 15488

Type	Part no.		Clamping range		Ø [inch]	Included in set
	ER standard	ER-UP	[mm]	[inch]		
ER 20 [inch]						
INCH SET ER 20	1120.00002	1120.00003	2.16–12.7	0.085–0.5	–	–
Ø 1/8"	1120.03182	1120.03183	3.18–2.18	0.125–0.085	–	•
Ø 3/16"	1120.04762	1120.04763	4.76–3.76	0.1875–0.1475	–	•
Ø 1/4"	1120.06352	1120.06353	6.35–5.35	0.25–0.21	–	•
Ø 5/16"	1120.07942	1120.07943	7.94–6.94	0.3125–0.2725	–	•
Ø 3/8"	1120.09532	1120.09533	9.53–8.53	0.375–0.335	–	•
Ø 7/16"	1120.11112	1120.11113	11.11–10.11	0.4375–0.3975	–	•
Ø 1/2"	1120.12702	1120.12703	12.7–11.7	0.5–0.46	–	•
ER 25 [mm]						
SET ER 25	1125.00000	1125.00001	1.0–16.0	0.0394–0.6299	–	–
Ø 1.0 mm	1125.01000	1125.01001	1.0–0.5	0.0394–0.0197	1/32"	–
Ø 1.5 mm	1125.01500	1125.01501	1.5–1.0	0.0591–0.0394	–	–
Ø 2.0 mm	1125.02000	1125.02001	2.0–1.0	0.0787–0.0394	1/16"	•
Ø 2.5 mm	1125.02500	1125.02501	2.5–1.5	0.0984–0.0591	3/32"	–
Ø 3.0 mm	1125.03000	1125.03001	3.0–2.0	0.1181–0.0787	–	•
Ø 3.5 mm	1125.03500	1125.03501	3.5–2.5	0.1378–0.0984	–	–
Ø 4.0 mm	1125.04000	1125.04001	4.0–3.0	0.1575–0.1181	5/32"	•
Ø 4.5 mm	1125.04500	1125.04501	4.5–3.5	0.1772–0.1378	–	–
Ø 5.0 mm	1125.05000	1125.05001	5.0–4.0	0.1969–0.1575	–	•
Ø 5.5 mm	1125.05500	1125.05501	5.5–4.5	0.2165–0.1772	–	–
Ø 6.0 mm	1125.06000	1125.06001	6.0–5.0	0.2362–0.1969	7/32"	•
Ø 6.5 mm	1125.06500	1125.06501	6.5–5.5	0.2559–0.2165	–	–
Ø 7.0 mm	1125.07000	1125.07001	7.0–6.0	0.2756–0.2362	–	•
Ø 7.5 mm	1125.07500	1125.07501	7.5–6.5	0.2953–0.2559	9/32"	–
Ø 8.0 mm	1125.08000	1125.08001	8.0–7.0	0.315–0.2756	–	•
Ø 8.5 mm	1125.08500	1125.08501	8.5–7.5	0.3346–0.2953	–	–
Ø 9.0 mm	1125.09000	1125.09001	9.0–8.0	0.3543–0.315	11/32"	•
Ø 9.5 mm	1125.09500	1125.09501	9.5–8.5	0.374–0.3346	–	–
Ø 10.0 mm	1125.10000	1125.10001	10.0–9.0	0.3937–0.3543	–	•
Ø 10.5 mm	1125.10500	1125.10501	10.5–9.5	0.4134–0.374	13/32"	–
Ø 11.0 mm	1125.11000	1125.11001	11.0–10.0	0.4331–0.3937	–	•
Ø 11.5 mm	1125.11500	1125.11501	11.5–10.5	0.4528–0.4134	–	–
Ø 12.0 mm	1125.12000	1125.12001	12.0–11.0	0.4724–0.4331	15/32"	•
Ø 12.5 mm	1125.12500	1125.12501	12.5–11.5	0.4921–0.4528	–	–
Ø 13.0 mm	1125.13000	1125.13001	13.0–12.0	0.5118–0.4724	–	•
Ø 13.5 mm	1125.13500	1125.13501	13.5–12.5	0.5315–0.4921	17/32"	–
Ø 14.0 mm	1125.14000	1125.14001	14.0–13.0	0.5512–0.5118	–	•

Included in the ER sets are all marked collets within that size and the matching collet tray ZWT.

* Approx. inch sizing

ER standard collets and ultraprecision collets ER-UP

ER std.	ER-UP
DIN 6499-B	DIN 6499-B
ISO 15488	ISO 15488

Type	Part no.		Clamping range		Ø [inch]	Included in set
	ER standard	ER-UP	[mm]	[inch]		
Ø 14.5 mm	1125.14500	1125.14501	14.5 – 13.5	0.5709 – 0.5315	–	–
Ø 15.0 mm	1125.15000	1125.15001	15.0 – 14.0	0.5906 – 0.5512	–	•
Ø 15.5 mm	1125.15500	1125.15501	15.5 – 14.5	0.6102 – 0.5709	19/32"	–
Ø 16.0 mm	1125.16000	1125.16001	16.0 – 15.0	0.6299 – 0.5905	–	•
Ø 17.0 mm	1125.17000	1125.17001	17.0 – 16.0	0.6693 – 0.6299	21/32"	–

ER 25 [inch]

INCH SET ER 25	1125.00002	1125.00003	2.16 – 15.88	0.085 – 0.625	–	–
Ø 1/8"	1125.03182	1125.03183	3.18 – 2.16	0.125 – 0.085	–	•
Ø 3/16"	1125.04762	1125.04763	4.76 – 3.75	0.1875 – 0.1475	–	•
Ø 1/4"	1125.06352	1125.06353	6.35 – 5.33	0.25 – 0.21	–	•
Ø 5/16"	1125.07942	1125.07943	7.94 – 6.92	0.3125 – 0.2725	–	•
Ø 3/8"	1125.09532	1125.09533	9.53 – 8.51	0.375 – 0.335	–	•
Ø 7/16"	1125.11112	1125.11113	11.11 – 10.11	0.4375 – 0.3975	–	•
Ø 1/2"	1125.12702	1125.12703	12.70 – 11.68	0.5 – 0.46	–	•
Ø 9/16"	1125.14292	1125.14293	14.29 – 13.27	0.5625 – 0.5225	–	•
Ø 5/8"	1125.15882	1125.15883	15.88 – 14.78	0.625 – 0.582	–	•

ER 32 [mm]

SET ER 32	1132.00000	1132.00001	2.0 – 20.0	0.0787 – 0.7874	–	–
Ø 2.0 mm	1132.02000	1132.02001	2.0 – 1.0	0.0787 – 0.0394	1/16"	–
Ø 2.5 mm	1132.02500	1132.02501	2.5 – 1.5	0.0984 – 0.0591	3/32"	–
Ø 3.0 mm	1132.03000	1132.03001	3.0 – 2.0	0.1181 – 0.0787	–	•
Ø 3.5 mm	1132.03500	1132.03501	3.5 – 2.5	0.1378 – 0.0984	–	–
Ø 4.0 mm	1132.04000	1132.04001	4.0 – 3.0	0.1575 – 0.1181	5/32"	•
Ø 4.5 mm	1132.04500	1132.04501	4.5 – 3.5	0.1772 – 0.1378	–	–
Ø 5.0 mm	1132.05000	1132.05001	5.0 – 4.0	0.1969 – 0.1575	–	•
Ø 5.5 mm	1132.05500	1132.05501	5.5 – 4.5	0.2165 – 0.1772	–	–
Ø 6.0 mm	1132.06000	1132.06001	6.0 – 5.0	0.2362 – 0.1969	7/32"	•
Ø 6.5 mm	1132.06500	1132.06501	6.5 – 5.5	0.2559 – 0.2165	–	–
Ø 7.0 mm	1132.07000	1132.07001	7.0 – 6.0	0.2756 – 0.2362	–	•
Ø 7.5 mm	1132.07500	1132.07501	7.5 – 6.5	0.2953 – 0.2559	9/32"	–
Ø 8.0 mm	1132.08000	1132.08001	8.0 – 7.0	0.315 – 0.2756	–	•
Ø 8.5 mm	1132.08500	1132.08501	8.5 – 7.5	0.3346 – 0.2953	–	–
Ø 9.0 mm	1132.09000	1132.09001	9.0 – 8.0	0.3543 – 0.315	11/32"	•
Ø 9.5 mm	1132.09500	1132.09501	9.5 – 8.5	0.374 – 0.3346	–	–
Ø 10.0 mm	1132.10000	1132.10001	10.0 – 9.0	0.3937 – 0.3543	–	•
Ø 10.5 mm	1132.10500	1132.10501	10.5 – 9.5	0.4134 – 0.374	13/32"	–
Ø 11.0 mm	1132.11000	1132.11001	11.0 – 10.0	0.4331 – 0.3937	–	•

Included in the ER sets are all marked collets within that size and the matching collet tray ZWT.

For further technical information, please refer to page 158.

* Approx. inch sizing

ER standard collets and ultraprecision collets ER-UP

ER std.	ER-UP
DIN 6499-B	DIN 6499-B
ISO 15488	ISO 15488

Type	Part no.		Clamping range		Ø [inch]	Included in set
	ER standard	ER-UP	[mm]	[inch]		
ER 32 [mm] continued						
Ø 11.5 mm	1132.11500	1132.11501	11.5 – 10.5	0.4528 – 0.4134	–	–
Ø 12.0 mm	1132.12000	1132.12001	12.0 – 11.0	0.4724 – 0.4331	15/32"	•
Ø 12.5 mm	1132.12500	1132.12501	12.5 – 11.5	0.4921 – 0.4528	–	–
Ø 13.0 mm	1132.13000	1132.13001	13.0 – 12.0	0.5118 – 0.4724	–	•
Ø 13.5 mm	1132.13500	1132.13501	13.5 – 12.5	0.5315 – 0.4921	17/32"	–
Ø 14.0 mm	1132.14000	1132.14001	14.0 – 13.0	0.5512 – 0.5118	–	•
Ø 14.5 mm	1132.14500	1132.14501	14.5 – 13.5	0.5709 – 0.5315	–	–
Ø 15.0 mm	1132.15000	1132.15001	15.0 – 14.0	0.5906 – 0.5512	–	•
Ø 15.5 mm	1132.15500	1132.15501	15.5 – 14.5	0.6102 – 0.5709	19/32"	–
Ø 16.0 mm	1132.16000	1132.16001	16.0 – 15.0	0.63299 – 0.5906	–	•
Ø 16.5 mm	1132.16500	1132.16501	16.5 – 15.5	0.6496 – 0.6102	–	–
Ø 17.0 mm	1132.17000	1132.17001	17.0 – 16.0	0.6693 – 0.6299	21/32"	•
Ø 17.5 mm	1132.17500	1132.17501	17.5 – 16.5	0.689 – 0.6496	–	–
Ø 18.0 mm	1132.18000	1132.18001	18.0 – 17.0	0.7087 – 0.6693	–	•
Ø 18.5 mm	1132.18500	1132.18501	18.5 – 17.5	0.7283 – 0.689	23/32"	–
Ø 19.0 mm	1132.19000	1132.19001	19.0 – 18.0	0.748 – 0.7078	–	•
Ø 19.5 mm	1132.19500	1132.19501	19.5 – 18.5	0.7677 – 0.7284	–	–
Ø 20.0 mm	1132.20000	1132.20001	20.0 – 19.0	0.7874 – 0.748	25/32"	•
Ø 21.0 mm	1132.21000	1132.21001	21.0 – 20.0	0.8268 – 0.7874	–	–
Ø 22.0 mm	1132.22000	1132.22001	22.0 – 21.0	0.8661 – 0.8268	–	–

ER 32 [inch]						
INCH SET ER 32	1132.00002	1132.00003	2.16 – 20.64	0.085 – 0.8125	–	–
Ø 1/8"	1132.03182	1132.03183	3.18 – 2.16	0.125 – 0.085	–	•
Ø 3/16"	1132.04762	1132.04763	4.76 – 3.75	0.1875 – 0.1475	–	•
Ø 1/4"	1132.06352	1132.06353	6.35 – 5.33	0.25 – 0.21	–	•
Ø 5/16"	1132.07942	1132.07943	7.94 – 6.92	0.3125 – 0.2725	–	•
Ø 3/8"	1132.09532	1132.09533	9.53 – 8.51	0.375 – 0.335	–	•
Ø 7/16"	1132.11112	1132.11113	11.11 – 10.1	0.4375 – 0.3975	–	•
Ø 1/2"	1132.12702	1132.12703	12.7 – 11.68	0.5 – 0.46	–	•
Ø 9/16"	1132.14292	1132.14293	14.29 – 13.27	0.5625 – 0.5225	–	•
Ø 5/8"	1132.15882	1132.15883	15.88 – 14.86	0.625 – 0.585	–	•
Ø 11/16"	1132.17462	1132.17463	17.46 – 16.45	0.6875 – 0.6475	–	•
Ø 3/4"	1132.19052	1132.19053	19.05 – 18.03	0.75 – 0.71	–	•
Ø 13/16"	1132.20642	1132.20643	20.64 – 19.62	0.8125 – 0.7725	–	•

Included in the ER sets are all marked collets within that size and the matching collet tray ZWT.

* Approx. inch sizing

ER standard collets and ultraprecision collets ER-UP

ER std.	ER-UP
DIN 6499-B	DIN 6499-B
ISO 15488	ISO 15488

Type	Part no.		Clamping range		Ø [inch]	Included in set
	ER standard	ER-UP	[mm]	[inch]		
ER 40 [mm]						
SET ER 40	1140.00000	1140.00001	3.0–26.0	0.1181–1.0236	–	–
Ø 3.0 mm	1140.03000	1140.03001	3.0–2.0	0.1181–0.0787	3/32"	–
Ø 3.5 mm	1140.03500	1140.03501	3.5–2.5	0.1378–0.0984	–	–
Ø 4.0 mm	1140.04000	1140.04001	4.0–3.0	0.1575–0.1181	5/32"	•
Ø 4.5 mm	1140.04500	1140.04501	4.5–3.5	0.1772–0.1378	–	–
Ø 5.0 mm	1140.05000	1140.05001	5.0–4.0	0.1969–0.1575	–	•
Ø 5.5 mm	1140.05500	1140.05501	5.5–4.5	0.2165–0.1772	–	–
Ø 6.0 mm	1140.06000	1140.06001	6.0–5.0	0.2362–0.1969	7/32"	•
Ø 6.5 mm	1140.06500	1140.06501	6.5–5.5	0.2559–0.2165	–	–
Ø 7.0 mm	1140.07000	1140.07001	7.0–6.0	0.2756–0.2362	–	•
Ø 7.5 mm	1140.07500	1140.07501	7.5–6.5	0.2953–0.2559	9/32"	–
Ø 8.0 mm	1140.08000	1140.08001	8.0–7.0	0.315–0.2756	–	•
Ø 8.5 mm	1140.08500	1140.08501	8.5–7.5	0.3346–0.2953	–	–
Ø 9.0 mm	1140.09000	1140.09001	9.0–8.0	0.3543–0.315	–	•
Ø 9.5 mm	1140.09500	1140.09501	9.5–8.5	0.374–0.3346	11/32"	–
Ø 10.0 mm	1140.10000	1140.10001	10.0–9.0	0.3937–0.3543	–	•
Ø 10.5 mm	1140.10500	1140.10501	10.5–9.5	0.4134–0.374	13/32"	–
Ø 11.0 mm	1140.11000	1140.11001	11.0–10.0	0.4331–0.3937	–	•
Ø 11.5 mm	1140.11500	1140.11501	11.5–10.5	0.4528–0.4134	–	–
Ø 12.0 mm	1140.12000	1140.12001	12.0–11.0	0.4724–0.4331	15/32"	•
Ø 12.5 mm	1140.12500	1140.12501	12.5–11.5	0.4921–0.4528	–	–
Ø 13.0 mm	1140.13000	1140.13001	13.0–12.0	0.5118–0.4724	–	•
Ø 13.5 mm	1140.13500	1140.13501	13.5–12.5	0.5315–0.4921	17/32"	–
Ø 14.0 mm	1140.14000	1140.14001	14.0–13.0	0.5512–0.5118	–	•
Ø 14.5 mm	1140.14500	1140.14501	14.5–13.5	0.5709–0.5315	–	–
Ø 15.0 mm	1140.15000	1140.15001	15.0–14.0	0.5906–0.5512	–	•
Ø 15.5 mm	1140.15500	1140.15501	15.5–14.5	0.6102–0.5709	19/32"	–
Ø 16.0 mm	1140.16000	1140.16001	16.0–15.0	0.6299–0.5906	–	•
Ø 16.5 mm	1140.16500	1140.16501	16.5–15.5	0.6496–0.6102	–	–
Ø 17.0 mm	1140.17000	1140.17001	17.0–16.0	0.6693–0.6299	21/32"	•
Ø 17.5 mm	1140.17500	1140.17501	17.5–16.5	0.689–0.6496	–	–
Ø 18.0 mm	1140.18000	1140.18001	18.0–17.0	0.7078–0.6693	–	•
Ø 18.5 mm	1140.18500	1140.18501	18.5–17.5	0.7283–0.689	23/32"	–
Ø 19.0 mm	1140.19000	1140.19001	19.0–18.0	0.748–0.7078	–	•
Ø 19.5 mm	1140.19500	1140.19501	19.5–18.5	0.7677–0.7283	–	–
Ø 20.0 mm	1140.20000	1140.20001	20.0–19.0	0.7874–0.748	25/32"	•
Ø 20.5 mm	1140.20500	1140.20501	20.5–19.5	0.8071–0.7677	–	–
Ø 21.0 mm	1140.21000	1140.21001	21.0–20.0	0.8268–0.7874	–	•

Included in the ER sets are all marked collets within that size and the matching collet tray ZWT.

For further technical information, please refer to page 158.

* Approx. inch sizing

ER standard collets and ultraprecision collets ER-UP

ER std.	ER-UP
DIN 6499-B	DIN 6499-B
ISO 15488	ISO 15488

Type	Part no.		Clamping range		Ø [inch]	Included in set
	ER standard	ER-UP	[mm]	[inch]		
ER 40 [mm] continued						
Ø 21.5 mm	1140.21500	1140.21501	21.5–20.5	0.8465–0.8071	27/32"	–
Ø 22.0 mm	1140.22000	1140.22001	22.0–21.0	0.8661–0.8268	–	•
Ø 22.5 mm	1140.22500	1140.22501	22.5–21.5	0.8858–0.8465	–	–
Ø 23.0 mm	1140.23000	1140.23001	23.0–22.0	0.9055–0.8661	–	•
Ø 23.5 mm	1140.23500	1140.23501	23.5–22.5	0.9252–0.8858	29/32"	–
Ø 24.0 mm	1140.24000	1140.24001	24.0–23.0	0.9449–0.9055	–	•
Ø 24.5 mm	1140.24500	1140.24501	24.5–23.5	0.9646–0.9252	–	–
Ø 25.0 mm	1140.25000	1140.25001	25.0–24.0	0.9843–0.9449	31/32"	•
Ø 25.5 mm	1140.25500	1140.25501	25.5–24.5	1.0039–0.9646	–	–
Ø 26.0 mm	1140.26000	1140.26001	26.0–25.0	1.0236–0.9843	–	•
Ø 27.0 mm	1140.27000	1140.27001	27.0–26.0	1.063–1.0236	1 1/16"	–
Ø 28.0 mm	1140.28000	1140.28001	28.0–27.0	1.1024–1.063	1 3/32"	–
Ø 29.0 mm	1140.29000	1140.29001	29.0–28.0	1.1417–1.1024	1 1/8"	–
Ø 30.0 mm	1140.30000	1140.30001	30.0–29.0	1.1811–1.1417	1 5/32"	–

ER 40 [inch]						
INCH SET ER 40	1140.00002	1140.00003	2.16–25.4	0.085–1.0	–	–
Ø 1/8"	1140.03182	1140.03183	3.18–2.16	0.125–0.085	–	•
Ø 3/16"	1140.04762	1140.04763	4.76–3.75	0.1875–0.1475	–	•
Ø 1/4"	1140.06352	1140.06353	6.35–5.33	0.25–0.21	–	•
Ø 5/16"	1140.07942	1140.07943	7.94–6.92	0.3125–0.2725	–	•
Ø 3/8"	1140.09532	1140.09533	9.53–8.51	0.375–0.335	–	•
Ø 7/16"	1140.11112	1140.11113	11.11–10.1	0.4375–0.3975	–	•
Ø 1/2"	1140.12702	1140.12703	12.70–11.68	0.5–0.46	–	•
Ø 9/16"	1140.14292	1140.14293	14.29–13.27	0.5625–0.5225	–	•
Ø 5/8"	1140.15882	1140.15883	15.88–14.86	0.625–0.585	–	•
Ø 11/16"	1140.17462	1140.17463	17.46–16.45	0.6875–0.6475	–	•
Ø 3/4"	1140.19052	1140.19053	19.05–18.03	0.75–0.71	–	•
Ø 13/16"	1140.20642	1140.20643	20.64–19.62	0.8125–0.7725	–	•
Ø 7/8"	1140.22232	1140.22233	22.23–21.21	0.875–0.835	–	•
Ø 1"	1140.25402	1140.25403	25.40–24.38	1.0–0.96	–	•

Included in the ER sets are all marked collets within that size and the matching collet tray ZWT.

* Approx. inch sizing

Expert advice

REGO-FIX ER-UP collets are available with a new rust protection for improved collet lifetime upon request.

ER standard collets and ultraprecision collets ER-UP

ER std.	ER-UP
DIN 6499-B	DIN 6499-B
ISO 15488	ISO 15488

Type	Part no.		Clamping range		Ø [inch]	Included in set
	ER standard	ER-UP	[mm]	[inch]		
ER 50 [mm]						
SET ER 50	1150.00000	1150.00001	10.0–34.0	0.2362–1.3386	–	–
Ø 6.0 mm	1150.06000	1150.06001	6.0–4.0	0.2362–0.1575	3/16"	–
Ø 8.0 mm	1150.08000	1150.08001	8.0–6.0	0.315–0.2362	1/4"	–
Ø 10.0 mm	1150.10000	1150.10001	10.0–8.0	0.3937–0.315	3/8"	–
Ø 12.0 mm	1150.12000	1150.12001	12.0–10.0	0.4724–0.3937	7/16"	•
Ø 14.0 mm	1150.14000	1150.14001	14.0–12.0	0.5512–0.4724	1/2"	•
Ø 16.0 mm	1150.16000	1150.16001	16.0–14.0	0.63–0.5512	5/8"	•
Ø 18.0 mm	1150.18000	1150.18001	18.0–16.0	0.7087–0.6299	11/16"	•
Ø 20.0 mm	1150.20000	1150.20001	20.0–18.0	0.7874–0.7087	3/4"	•
Ø 22.0 mm	1150.22000	1150.22001	22.0–20.0	0.8661–0.7874	13/16"	•
Ø 24.0 mm	1150.24000	1150.24001	24.0–22.0	0.9449–0.8661	7/8"	•
Ø 25.0 mm	1150.25000	1150.25001	25.0–23.0	0.9843–0.9055	31/32"	–
Ø 26.0 mm	1150.26000	1150.26001	26.0–24.0	1.0236–0.9449	1"	•
Ø 28.0 mm	1150.28000	1150.28001	28.0–26.0	1.1024–1.0236	1 1/16"	•
Ø 30.0 mm	1150.30000	1150.30001	30.0–28.0	1.1811–1.1024	1 1/8"	•
Ø 32.0 mm	1150.32000	1150.32001	32.0–30.0	1.2598–1.1811	1 1/4"	•
Ø 34.0 mm	1150.34000	1150.34001	34.0–32.0	1.3386–1.2598	1 5/16"	•
Ø 36.0 mm	1150.36000	1150.36001	36.0–34.0	1.4173–1.3386	1 3/8"	–

Included in the ER sets are all marked collets within that size and the matching collet tray ZWT.

For further technical information, please refer to page 158.



ER standard and ER-UP

Type	Part no.	Clamping range		Incl. in set
		[mm]	[inch]	
ER 11-DM [mm]				
Ø 3.0 mm	1211.03000	3.0–2.75	0.1181–0.1083	–
Ø 4.0 mm	1211.04000	4.0–3.75	0.1575–0.1476	–
Ø 5.0 mm	1211.05000	5.0–4.75	0.1969–0.187	–
Ø 6.0 mm	1211.06000	6.0–5.75	0.2362–0.2264	–
Ø 7.0 mm	1211.07000	7.0–6.75	0.2756–0.2657	–
ER 11-DM [inch]				
Ø 1/8"	1211.03182	3.18–2.93	0.125–0.1154	–
Ø 3/16"	1211.04762	4.76–4.51	0.1875–0.1776	–
Ø 7/32"	1211.05562	5.56–5.31	0.2188–0.2091	–
Ø 1/4"	1211.06352	6.35–6.1	0.25–0.2402	–
ER 16-DM [mm]				
SET ER 16-DM	1216.00000	3.0–10.0	0.1181–0.3937	–
Ø 3.0 mm	1216.03000	3.0 h9	0.1181 h9	•
Ø 4.0 mm	1216.04000	4.0 h9	0.1575 h9	•
Ø 5.0 mm	1216.05000	5.0–4.5	0.1969–0.1772	•
Ø 6.0 mm	1216.06000	6.0–5.5	0.2362–0.2165	•
Ø 7.0 mm	1216.07000	7.0–6.5	0.2756–0.2559	•
Ø 8.0 mm	1216.08000	8.0–7.5	0.315–0.2953	•
Ø 9.0 mm	1216.09000	9.0–8.5	0.3543–0.3346	•
Ø 10.0 mm	1216.10000	10.0–9.5	0.3937–0.374	•

For further technical information, please refer to page 161.



Expert advice

Please note that the ER-DM collets are not suitable for use with reCool®.

Type	Part no.	Clamping range		Incl. in set
		[mm]	[inch]	
ER 16-DM [inch]				
INCH SET ER 16-DM	1216.00002	3.18 – 10.32	0.125 – 0.4063	–
Ø 1/8"	1216.03182	3.18 h9	0.125 h9	•
Ø 5/32"	1216.03972	3.97 h9	0.1563 h9	–
Ø 3/16"	1216.04762	4.76 h9	0.1875 h9	•
Ø 7/32"	1216.05562	5.56 – 5.06	0.2188 – 0.1991	–
Ø 1/4"	1216.06352	6.35 – 5.85	0.25 – 0.2303	•
Ø 9/32"	1216.07142	7.14 – 6.64	0.2813 – 0.2616	–
Ø 5/16"	1216.07942	7.94 – 7.44	0.3125 – 0.2928	•
Ø 11/32"	1216.08732	8.73 – 8.23	0.3438 – 0.3241	–
Ø 3/8"	1216.09532	9.53 – 9.02	0.375 – 0.3553	•
Ø 13/32"	1216.10322	10.32 – 9.82	0.4063 – 0.3866	–
ER 20-DM [mm]				
SET ER 20-DM	1220.00000	3.0 – 13.0	0.1181 – 0.5118	–
Ø 3.0 mm	1220.03000	3.0 h9	0.1181 h9	•
Ø 4.0 mm	1220.04000	4.0 h9	0.1575 h9	•
Ø 5.0 mm	1220.05000	5.0 h9	0.1969 h9	•
Ø 6.0 mm	1220.06000	6.0 h9	0.2362 h9	•
Ø 7.0 mm	1220.07000	7.0 – 6.5	0.2756 – 0.2559	•
Ø 8.0 mm	1220.08000	8.0 – 7.5	0.315 – 0.2953	•
Ø 9.0 mm	1220.09000	9.0 – 8.5	0.3543 – 0.3346	•
Ø 10.0 mm	1220.10000	10.0 – 9.5	0.3937 – 0.374	•
Ø 11.0 mm	1220.11000	11.0 – 10.5	0.4331 – 0.4134	•
Ø 12.0 mm	1220.12000	12.0 – 11.5	0.4724 – 0.4528	•
Ø 13.0 mm	1220.13000	13.0 – 12.5	0.5118 – 0.4921	•
ER 20-DM [inch]				
INCH SET ER 20-DM	1220.00002	3.18 – 12.7	0.125 – 0.5	–
Ø 1/8"	1220.03182	3.18 h9	0.125 h9	•
Ø 5/32"	1220.03972	3.97 h9	0.1563 h9	–
Ø 3/16"	1220.04762	4.76 h9	0.1875 h9	•
Ø 7/32"	1220.05562	5.56 h9	0.2188 h9	–
Ø 1/4"	1220.06352	6.35 h9	0.25 h9	•
Ø 9/32"	1220.07142	7.14 – 6.64	0.2813 – 0.2616	–
Ø 5/16"	1220.07942	7.94 – 7.44	0.3125 – 0.2928	•
Ø 11/32"	1220.08732	8.73 – 8.23	0.3438 – 0.3241	–
Ø 3/8"	1220.09532	9.53 – 9.02	0.375 – 0.3553	•
Ø 13/32"	1220.10322	10.32 – 9.82	0.4063 – 0.3866	–
Ø 7/16"	1220.11112	11.11 – 10.61	0.4375 – 0.4178	•
Ø 15/32"	1220.11912	11.91 – 11.41	0.4687 – 0.4491	–
Ø 1/2"	1220.12702	12.7 – 12.2	0.5 – 0.4803	•

Type	Part no.	Clamping range		Incl. in set
		[mm]	[inch]	
ER 25-DM [mm]				
SET ER 25-DM	1225.00000	6.0 – 16.0	0.2362 – 0.6299	–
Ø 6.0 mm	1225.06000	6.0 h9	0.2362 h9	•
Ø 7.0 mm	1225.07000	7.0 h9	0.2756 h9	–
Ø 8.0 mm	1225.08000	8.0 – 7.5	0.315 – 0.2953	•
Ø 9.0 mm	1225.09000	9.0 – 8.5	0.3543 – 0.3347	–
Ø 10.0 mm	1225.10000	10.0 – 9.5	0.3937 – 0.374	•
Ø 11.0 mm	1225.11000	11.0 – 10.5	0.4331 – 0.4134	–
Ø 12.0 mm	1225.12000	12.0 – 11.5	0.4724 – 0.4528	•
Ø 13.0 mm	1225.13000	13.0 – 12.5	0.5118 – 0.4921	–
Ø 14.0 mm	1225.14000	14.0 – 13.5	0.5512 – 0.5315	•
Ø 15.0 mm	1225.15000	15.0 – 14.5	0.5906 – 0.5709	–
Ø 16.0 mm	1225.16000	16.0 – 15.5	0.6299 – 0.6102	•

ER 25-DM [inch]				
INCH SET ER 25-DM	1225.00002	6.35 – 15.88	0.25 – 0.625	–
Ø 7/32"	1225.05562	5.56 h9	0.2188 h9	–
Ø 1/4"	1225.06352	6.35 h9	0.2500 h9	•
Ø 9/32"	1225.07142	7.14 h9	0.2813 h9	–
Ø 5/16"	1225.07942	7.94 – 7.44	0.3125 – 0.2928	•
Ø 11/32"	1225.08732	8.73 – 8.23	0.3438 – 0.3241	–
Ø 3/8"	1225.09532	9.53 – 9.02	0.375 – 0.3553	•
Ø 13/32"	1225.10322	10.32 – 9.82	0.4063 – 0.3866	–
Ø 7/16"	1225.11112	11.11 – 10.61	0.4375 – 0.4178	•
Ø 15/32"	1225.11912	11.91 – 11.41	0.4687 – 0.4491	–
Ø 1/2"	1225.12702	12.7 – 12.2	0.5 – 0.4803	•
Ø 17/32"	1225.13492	13.49 – 12.99	0.5313 – 0.5116	–
Ø 9/16"	1225.14292	14.29 – 13.79	0.5625 – 0.5428	•
Ø 19/32"	1225.15082	15.08 – 14.58	0.5934 – 0.5741	–
Ø 5/8"	1225.15882	15.88 – 15.38	0.625 – 0.6055	•

ER 32-DM [mm]				
SET ER 32-DM	1232.00000	6.0 – 20.0	0.2362 – 0.7874	–
Ø 6.0 mm	1232.06000	6.0 h9	0.2362 h9	•
Ø 7.0 mm	1232.07000	7.0 h9	0.2756 h9	–
Ø 8.0 mm	1232.08000	8.0 – 7.5	0.315 – 0.2953	•
Ø 9.0 mm	1232.09000	9.0 – 8.5	0.3543 – 0.3346	–
Ø 10.0 mm	1232.10000	10.0 – 9.5	0.3937 – 0.374	•
Ø 11.0 mm	1232.11000	11.0 – 10.5	0.4331 – 0.4134	–

Type	Part no.	Clamping range		Incl. in set
		[mm]	[inch]	
Ø 12.0 mm	1232.12000	12.0 – 11.5	0.4724 – 0.4528	•
Ø 13.0 mm	1232.13000	13.0 – 12.5	0.5118 – 0.4921	–
Ø 14.0 mm	1232.14000	14.0 – 13.5	0.5512 – 0.5315	•
Ø 15.0 mm	1232.15000	15.0 – 14.5	0.5906 – 0.5709	–
Ø 16.0 mm	1232.16000	16.0 – 15.5	0.6299 – 0.6102	•
Ø 17.0 mm	1232.17000	17.0 – 16.5	0.6693 – 0.6496	–
Ø 18.0 mm	1232.18000	18.0 – 17.5	0.7087 – 0.689	•
Ø 19.0 mm	1232.19000	19.0 – 18.5	0.748 – 0.7283	–
Ø 20.0 mm	1232.20000	20.0 – 19.5	0.7874 – 0.7677	•

ER 32-DM [inch]

INCH SET ER 32-DM	1232.00002	6.35 – 19.05	0.25 – 0.75	–
Ø 1/4"	1232.06352	6.35 h9	0.25 h9	•
Ø 9/32"	1232.07142	7.15 h9	0.2813 h9	–
Ø 5/16"	1232.07942	7.94 – 7.44	0.3125 – 0.2928	•
Ø 11/32"	1232.08732	8.73 – 8.23	0.3438 – 0.3241	–
Ø 3/8"	1232.09532	9.53 – 9.02	0.375 – 0.3553	•
Ø 13/32"	1232.10322	10.32 – 9.82	0.4063 – 0.3866	–
Ø 7/16"	1232.11112	11.11 – 10.61	0.4375 – 0.4178	•
Ø 15/32"	1232.11912	11.91 – 11.41	0.4687 – 0.4491	–
Ø 1/2"	1232.12702	12.7 – 12.2	0.5 – 0.4803	•
Ø 17/32"	1232.13492	13.5 – 12.99	0.5313 – 0.5116	–
Ø 9/16"	1232.14292	14.29 – 13.79	0.5625 – 0.5428	•
Ø 19/32"	1232.15082	15.07 – 14.58	0.5934 – 0.5741	–
Ø 5/8"	1232.15882	15.88 – 15.38	0.625 – 0.6055	•
Ø 21/32"	1232.16672	16.67 – 16.17	0.6563 – 0.6366	–
Ø 11/16"	1232.17462	17.46 – 16.96	0.6875 – 0.6678	•
Ø 23/32"	1232.18262	18.26 – 17.76	0.7188 – 0.6991	–
Ø 3/4"	1232.19052	19.05 – 18.55	0.75 – 0.7303	•

ER 40-DM [mm]

Ø 6.0 mm	1240.06000	6.0 h9	0.2362 h9	–
Ø 8.0 mm	1240.08000	8.0 h9	0.3150 h9	–
Ø 10.0 mm	1240.10000	10.0 – 9.5	0.3937 – 0.374	–
Ø 11.0 mm	1240.11000	11.0 – 10.5	0.4331 – 0.4134	–
Ø 12.0 mm	1240.12000	12.0 – 11.5	0.4724 – 0.4528	–
Ø 13.0 mm	1240.13000	13.0 – 12.5	0.5118 – 0.4921	–
Ø 14.0 mm	1240.14000	14.0 – 13.5	0.5512 – 0.5315	–
Ø 15.0 mm	1240.15000	15.0 – 14.5	0.5906 – 0.5709	–

For further technical information, please refer to page 161.

Type	Part no.	Clamping range		Incl. in set
		[mm]	[inch]	
ER 40-DM [mm] continued				
Ø 16.0 mm	1240.16000	16.0–15.5	0.6299–0.6102	–
Ø 17.0 mm	1240.17000	17.0–16.5	0.6693–0.6496	–
Ø 18.0 mm	1240.18000	18.0–17.5	0.7087–0.689	–
Ø 19.0 mm	1240.19000	19.0–18.5	0.748–0.7283	–
Ø 20.0 mm	1240.20000	20.0–19.5	0.7874–0.7677	–
Ø 21.0 mm	1240.21000	21.0–20.5	0.8268–0.8071	–
Ø 22.0 mm	1240.22000	22.0–21.5	0.8661–0.8465	–
Ø 23.0 mm	1240.23000	23.0–22.5	0.9055–0.8858	–
Ø 24.0 mm	1240.24000	24.0–23.5	0.9449–0.9252	–
Ø 25.0 mm	1240.25000	25.0–24.5	0.9843–0.9646	–
Ø 26.0 mm	1240.26000	26.0–25.5	1.0236–1.0039	–

ER 40-DM [inch]				
Ø 1/4"	1240.06352	6.35 h9	0.25n m h9	–
Ø 5/16"	1240.07942	7.94 h9	0.3125 h9	–
Ø 3/8"	1240.09532	9.53–9.02	0.375–0.3553	–
Ø 7/16"	1240.11112	11.11–10.61	0.4375–0.4178	–
Ø 1/2"	1240.12702	12.7–12.2	0.5–0.4803	–
Ø 9/16"	1240.14292	14.29–13.79	0.5625–0.5428	–
Ø 5/8"	1240.15882	15.88–15.38	0.62–0.6055	–
Ø 11/16"	1240.17462	17.46–16.96	0.6875–0.6678	–
Ø 3/4"	1240.19052	19.05–18.55	0.75–0.7303	–
Ø 13/16"	1240.20642	20.64–20.14	0.8123–0.7928	–
Ø 7/8"	1240.22232	22.23–21.72	0.875–0.8553	–
Ø 1"	1240.25402	25.4–24.9	1.0–0.9803	–

For further technical information, please refer to page 158.

Expert advice

Please note that DM collets are not compatible with Weldon or Whistle notch shafts. To achieve internal cooling with Weldon or Whistle notch shafts, use the REGO-FIX sealing disks ER/DS with your REGO-FIX ER collet.

Type	Part no.	[mm]	Ø [inch]
ER 32-SG [mm]			
Ø 12.0 mm	1332.12004S	12	–
Ø 16.0 mm	1332.16004S	16	–

Type	Part no.	[mm]	Ø [inch]
ER 32-SG [inch]			
Ø 1/2"	1332.12704S	12.7	1/2"
Ø 5/8"	1332.15884S	15.88	5/8"

Type	Part no.	[mm]	Ø [inch]
ER 40-SG [mm]			
Ø 16.0 mm	1340.16004S	16	–
Ø 20.0 mm	1340.20004S	20	–
Ø 25.0 mm	1340.25004S	25	–

Type	Part no.	[mm]	Ø [inch]
ER 40-SG [inch]			
Ø 5/8"	1340.15884S	15.88	5/8"
Ø 3/4"	1340.19054S	19.05	3/4"
Ø 1"	1340.25404S	25.4	1"

Type	Part no.
Threaded insert SGI [mm]	
Ø 12.0 mm	7694.12000
Ø 16.0 mm	7694.16000
Ø 20.0 mm	7694.20000
Ø 25.0 mm	7694.25000

Type	Part no.
Threaded insert SGI [inch]	
Ø 1/2"	7694.12700
Ø 5/8"	7694.15880
Ø 3/4"	7694.19050
Ø 1"	7694.25404

Expert Advice

Please note all ER-SG collets come standard with their corresponding insert.

Additional inserts may be purchased separately.



Learn more

For further information on secuRgrip®, please refer to page 12 and 13.

ER tapping collets ER-GB

Manufactured with a form-fitting internal square, the ER-GB collets successfully prevent the tap from slipping.

Key features

Tapping collets without axial compensation

Swiss quality

Made in Switzerland to ISO 9001 / ISO 14001.

Marking

Type and size (reduced collet selection errors).

Traceability

Lot number marking on all products for traceability through the entire manufacturing process.

Original REGO-FIX

Our long-lasting machining experience results in a well-engineered system. When buying REGO-FIX products pay attention to our quality seal: The triangle is our seal for outstanding quality made in Switzerland.

Interchangeable

With standard ER collet DIN 6499 / ISO 15488. No additional colletholders and clamping nuts necessary.

Wide product range

Sizes: ER-GB 11 to 50.
Standards: DIN, ISO, JIS (ANSI on request).

Strength: Square for tight grip of tap

Eliminates tap slippage in collets.

Matched tooling system for best fit

The compatibility of the entire system results in maximum precision, balance and tool life.

Tapping collets ER-GB These rigid tapping collets are compatible with taps per DIN, ISO, JIS and ANSI standards. The REGO-FIX ER-GB tapping collets are manufactured with an internal square. They are intended for use on CNC machines that have synchronized machine spindle speed and feed rate. Machines that have such rigid tapping capabilities require only minimal compensation. We recommend the use of our SSY Softsynchro® tapping holders. They compensate minimal synchronizing differences of CNC machines.

For machines without tapping option we recommend the use of our axial compensating GSF tapping holders. Please refer to page 70 for more information. For additional technical information and dimensions of taps on ER-GB, please refer to pages 164 and 167.



ER-GB

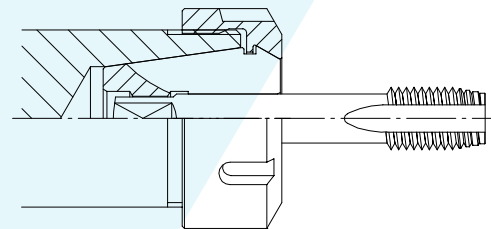

ER-GB

ER tapping collets

ER-GB

ER-GB [mm]

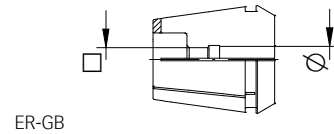

Dimensions [mm]		ER ... -GB								Standard
Ø	□	11	16	20	25	32	40	50		
2.5	2.1/2.0	1411.02500	-	-	-	-	-	-	DIN / ISO	
2.8	2.1	1411.02800	-	-	-	-	-	-	DIN	
3.5	2.7	1411.03500	-	-	-	-	-	-	DIN	
4.0	3.0	1411.04000	-	-	-	-	-	-	DIN	
4.0	3.15/3.2	1411.04002	1416.04002	1420.04002	1425.04002	1432.04002	-	-	ISO / JIS	
4.5	3.4	1411.04500	1416.04500	1420.04500	1425.04500	1432.04500	-	-	DIN	
5.0	4.0	1411.05002	1416.05002	1420.05002	1425.05002	1432.05002	-	-	ISO / JIS	
5.5	4.3	-	1416.05500	1420.05500	1425.05500	1432.05500	-	-	DIN	
5.5	4.5	-	1416.05501	1420.05501	1425.05501	1432.05501	-	-	JIS	
6.0	4.5	-	1416.06001	1420.06001	1425.06001	1432.06001	1440.06001	-	JIS	
6.0	4.9	1411.06000	1416.06000	1420.06000	1425.06000	1432.06000	1440.06000	-	DIN	
6.2	5.0	-	1416.06201	1420.06201	1425.06201	1432.06201	1440.06201	-	JIS	
6.3	5.0	-	1416.06302	1420.06302	1425.06302	1432.06302	1440.06302	-	ISO	
7.0	5.5	-	1416.07000	1420.07000	1425.07000	1432.07000	1440.07000	-	DIN / JIS	
7.1	5.6	-	1416.07102	1420.07102	1425.07102	1432.07102	1440.07102	-	ISO	
8.0	6.2/6.3	-	1416.08000	1420.08000	1425.08000	1432.08000	1440.08000	-	DIN / ISO	
8.5	6.5	-	1416.08501	1420.08501	1425.08501	1432.08501	1440.08501	-	JIS	
9.0	7.0/7.1	-	1416.09000	1420.09000	1425.09000	1432.09000	1440.09000	-	DIN / ISO	
10.0	8.0	-	-	1420.10000	1425.10000	1432.10000	1440.10000	-	DIN / ISO	
10.5	8.0	-	-	1420.10501	1425.10501	1432.10501	1440.10501	-	JIS	
11.0	9.0	-	-	1420.11000	1425.11000	1432.11000	1440.11000	-	DIN	
11.2	9.0	-	-	1420.11202	1425.11202	1432.11202	1440.11202	-	ISO	
12.0	9.0	-	-	1420.12000	1425.12000	1432.12000	1440.12000	-	DIN	
12.5	10.0	-	-	-	1425.12502	1432.12502	1440.12502	-	ISO / JIS	
14.0	11.0/11.2	-	-	-	1425.14000	1432.14000	1440.14000	-	DIN / ISO / JIS	
15.0	12.0	-	-	-	1425.15001	1432.15001	1440.15001	-	JIS	
16.0	12.0/12.5	-	-	-	1425.16000	1432.16000	1440.16000	-	DIN / ISO	
17.0	13.0	-	-	-	-	1432.17001	1440.17001	-	JIS	
18.0	14.0/14.5	-	-	-	-	1432.18000	1440.18000	-	DIN / ISO	
20.0	16.0	-	-	-	-	1432.20000	1440.20000	-	DIN / ISO	
22.0	18.0	-	-	-	-	-	1440.22000	1450.22000	DIN	
25.0	20.0	-	-	-	-	-	-	1450.25000	DIN	
28.0	22.0	-	-	-	-	-	-	1450.28000	DIN	
32.0	24.0	-	-	-	-	-	-	1450.32000	DIN	

ER tapping collets

ER-GB

ER-GB [inch]

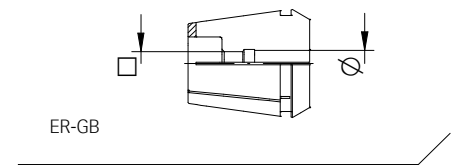

Dimensions [inch]		ER ... -GB							Standard
Ø	□	11	16	20	25	32	40		
0.141"	0.110"	1411.03585	1416.03585	-	-	-	-	ANSI	
0.168"	0.131"	1411.04275	1416.04275	1420.04275	1425.04275	1432.04275	-	ANSI	
0.194"	0.152"	1411.04935	1416.04935	1420.04935	1425.04935	1432.04935	-	ANSI	
0.220"	0.165"	-	1416.05595	1420.05595	1425.05595	1432.05595	-	ANSI	
0.255"	0.191"	-	1416.06485	1420.06485	1425.06485	1432.06485	1440.06485	ANSI	
0.318"	0.238"	-	1416.08085	1420.08085	1425.08085	1432.08085	1440.08085	ANSI	
0.323"	0.242"	-	-	1420.08215	1425.08215	1432.08215	1440.08215	ANSI	
0.367"	0.275"	-	-	1420.09325	1425.09325	1432.09325	1440.09325	ANSI	
0.381"	0.286"	-	-	1420.09685	1425.09685	1432.09685	1440.09685	ANSI	
0.429"	0.322"	-	-	-	1425.10905	1432.10905	1440.10905	ANSI	
0.437" •	0.328"	-	-	-	1425.11104	1432.11104	1440.11104	ANSI	
0.480"	0.360"	-	-	-	1425.12195	1432.12195	1440.12195	ANSI	
0.542"	0.406"	-	-	-	-	1432.13775	1440.13775	ANSI	
0.562" •	0.421"	-	-	-	-	1432.14274	1440.14274	ANSI	
0.590"	0.442"	-	-	-	1425.14995	1432.14995	1440.14995	ANSI	
0.652"	0.489"	-	-	-	-	1432.16565	1440.16565	ANSI	
0.687" •	0.515"	-	-	-	-	-	1440.17454	ANSI	
0.697"	0.523"	-	-	-	-	-	1440.17705	ANSI	
0.700" •	0.531"	-	-	-	-	-	1440.17784	ANSI	
0.760"	0.570"	-	-	-	-	-	1440.19305	ANSI	
0.800"	0.600"	-	-	-	-	-	1440.20325	ANSI	

• designates pipe tap

Tap Size	Shank	Square
No 0 - 6	0.141	0.110
1/16	0.141	0.110
3/32	0.141	0.110
1/8	0.141	0.110
5/32	0.168	0.131
No 8	0.168	0.131
3/16	0.194	0.152
No 9	0.194	0.152
No 10	0.194	0.152
1/4	0.255	0.191
5/16	0.318	0.238

Tap Size	Shank	Square
3/8	0.381	0.286
7/16	0.323	0.242
1/2	0.367	0.275
9/16	0.429	0.322
5/8	0.480	0.360
11/16	0.542	0.406
3/4	0.590	0.442
13/16	0.652	0.489
7/8	0.697	0.523
15/16	0.760	0.570
1	0.800	0.600



ER tapping collets PCM ET1

PCM ET1 tapping collets with axial compensation offer a smart and cost-effective toolholding option for machines which need axial compensation for tapping.

Key features

Tapping collets with axial compensation

Interchangeable

With REGO-FIX standard ER collet DIN 6499 / ISO 15488.

Compatibility

PCM ET1-12 is compatible with ER11 colletholders.

Cost saving

No expensive tapping tools necessary.

Spring tension

Adapted to tap size.

Compact

Very robust design with smallest space requirement.

Directions for use The following tapping process is recommended for tapping collets PCM ET1: Fast approach, then tapping feed with approximately 95 % of the pitch value, which uses 20 to 30 % of the compensation stroke when the spindle rotation and the feed movement are simultaneously reversed.

Return feed must be made with 100 % of the pitch, which maintains the sleeve of the tapping collet in the compensation stroke up to the tap disengagement; quick return can then be programmed with usual stroke security. The relatively long axial compensation assists easy programming.

When tapping with very high speed, an appropriate programming compensation may be necessary to balance the differences of inertia between the spindle and the feed movement on reverse. In order to not disturb the axial compensation, use external coolant supply only.

Please refer to page 66 for additional information on REGO-FIX tapping holders. For additional technical information and dimensions of taps on PCM ET1, please refer to pages 165.

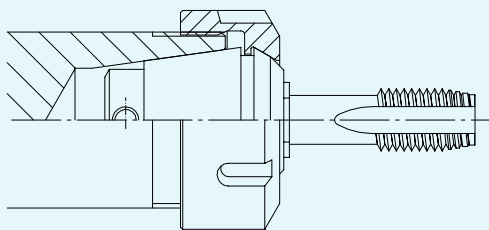

PCM ET1



PCM ET1

Expert advice

Not for coolant through tools and not for applications with sealing disks.

PCM ET1 [mm]

Shank Ø [mm]	PCM ET1- ...						Standard
	12	16	20	25	32	40	
1.4	1512.01400	1516.01400	-	-	-	-	DIN / ISO
1.6	1512.01600	1516.01600	-	-	-	-	DIN
1.8	1512.01800	1516.01800	-	-	-	-	DIN
2.0	1512.02000	1516.02000	-	-	-	-	DIN
2.2	1512.02200	1516.02200	1520.02200	-	-	-	ISO / JIS
2.24	1512.02240	1516.02240	1520.02240	-	-	-	DIN
2.5	1512.02500	1516.02500	1520.02500	1525.02500	-	-	ISO / JIS
2.8	1512.02800	1516.02800	1520.02800	1525.02800	-	-	DIN
3.0	1512.03000	1516.03000	1520.03000	1525.03000	-	-	JIS
3.15	1512.03150	1516.03150	1520.03150	1525.03150	-	-	JIS
3.5	1512.03500	1516.03500	1520.03500	1525.03500	-	-	DIN
3.55	1512.03550	1516.03550	1520.03550	1525.03550	-	-	JIS
4.0	-	1516.04000	1520.04000	1525.04000	-	-	ISO
4.5	-	1516.04500	1520.04500	1525.04500	1532.04500	-	DIN / JIS
5.0	-	1516.05000	1520.05000	1525.05000	1532.05000	-	ISO
5.5	-	1516.05500	1520.05500	1525.05500	1532.05500	-	DIN / ISO
5.6	-	1516.05600	1520.05600	1525.05600	1532.05600	-	JIS
6.0	-	1516.06000	1520.06000	1525.06000	1532.06000	1540.06000	DIN / ISO
6.2	-	1516.06200	1520.06200	1525.06200	1532.06200	1540.06200	DIN / ISO
6.3	-	1516.06300	1520.06300	1525.06300	1532.06300	1540.06300	JIS
7.0	-	-	1520.07000	1525.07000	1532.07000	1540.07000	DIN
7.1	-	-	-	1525.07100	1532.07100	1540.07100	ISO
8.0	-	-	-	1525.08000	1532.08000	1540.08000	DIN
8.5	-	-	-	1525.08500	1532.08500	1540.08500	ISO / JIS
9.0	-	-	-	1525.09000	1532.09000	1540.09000	DIN / ISO / JIS
10.0	-	-	-	1525.10000	1532.10000	1540.10000	JIS
10.5	-	-	-	-	1532.10500	1540.10500	DIN / ISO
11.0	-	-	-	-	1532.11000	1540.11000	JIS
11.2	-	-	-	-	1532.11200	1540.11200	DIN / ISO
12.0	-	-	-	-	1532.12000	1540.12000	DIN / ISO
12.5	-	-	-	-	1532.12500	1540.12500	DIN
14.0	-	-	-	-	-	1540.14000	DIN
15.0	-	-	-	-	-	1540.15000	DIN
16.0	-	-	-	-	-	1540.16000	DIN
17.0	-	-	-	-	-	1540.17000	JIS

PCM ET1-ER 12 is technically identical to ER 11 and fits all ER11 collets.

ER tapping collets

PCM ET1 [inch]

Shank Ø		PCM ET1- ...					
[inch]	[mm]	12	16	20	25	32	40
0.141	3.580	1512.03581	1516.03581	1520.03581	1525.03581	–	–
0.168	4.270	–	1516.04271	1520.04271	1525.04271	1532.04721	–
0.194	4.930	–	1516.04931	1520.04931	1525.04931	1532.04931	–
0.220	5.590	–	1516.05591	1520.05591	1525.05591	1532.05591	–
0.255	6.480	–	–	1520.06481	1525.06481	1532.06481	1540.06481
0.318	8.080	–	–	–	1525.08081	1532.08081	1540.08081
0.323	8.205	–	–	–	1525.08211	1532.08211	1540.08211
0.367	9.320	–	–	–	1525.09321	1532.09321	1540.09321
0.381	9.680	–	–	–	1525.09681	1532.09681	1540.09681
0.429	10.900	–	–	–	–	1532.10901	1540.10901
0.437	11.113	–	–	–	–	1532.11111	1540.11111
0.480	12.192	–	–	–	–	1532.12191	1540.12191
0.542	13.770	–	–	–	–	–	1540.13771
0.562	14.290	–	–	–	–	–	1540.14291
0.590	14.990	–	–	–	–	–	1540.14991
0.652	16.560	–	–	–	–	–	1540.16561
0.697	17.700	–	–	–	–	–	1540.17701

PCM ET1-ER 12 is technically identical to ER 11 and fits all ER11 collets.

Tap Size	Shank	Square
No 0 – 6	0.141	0.110
1/16	0.141	0.110
3/32	0.141	0.110
1/8	0.141	0.110
5/32	0.168	0.131
No 8	0.168	0.131
3/16	0.194	0.152
No 9	0.194	0.152
No 10	0.194	0.152
1/4	0.255	0.191
5/16	0.318	0.238

Tap Size	Shank	Square
3/8	0.381	0.286
7/16	0.323	0.242
1/2	0.367	0.275
9/16	0.429	0.322
5/8	0.480	0.360
11/16	0.542	0.406
3/4	0.590	0.442
13/16	0.652	0.489
7/8	0.697	0.523
15/16	0.760	0.570
1	0.800	0.600





Standard		Standard with bearing		Mini nut		Slip-off proof mini nut		External thread			Sealing and cooling disks		
Hi-Q®/ER	Hi-Q®/ERC	Hi-Q®/ERB	Hi-Q®/ERBC	Hi-Q®/ERM	Hi-Q®/ERMC	Hi-Q®/ERMX intRlox®	Hi-Q®/ERMXC intRlox®	ER MS	Hi-Q®/ERAX	Hi-Q®/ERAXC	reCool® RCR/RCS	DS/ER	KS/ER
page 114	page 116	page 118	page 118	page 120	page 120	page 122	page 122	page 124	page 126	page 126	page 128	page 134	page 142

B: bearing C: cooling M: mini thread X: slip-off proof

DS: sealing disk KS: coolant flush disk

Innovative products fitting your needs

We offer a wide selection of ER clamping nuts for virtually any application.

Wide selection available

- // Includes friction-bearing for higher clamping force
- // Available with sealing disk for coolant through tools
- // Mini nut with minimal external diameter
- // Clamping nut (for high rpm)
- // Externally threaded clamping nut for floating chucks, ERA Zero-Z® collet holder and live tooling
- // Slip-off proof mini clamping nut intrLox® for safe assembling

Torque comparison of different clamping nuts

REGO-FIX Hi-Q®/ER and Hi-Q®/ERB vs. competitor nuts / Source: In-house testing

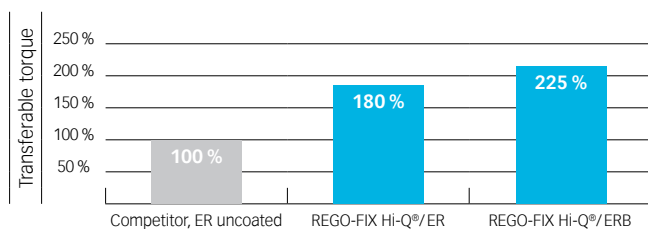

Key advantages

Rely on the original

Collet locking-system (pat. pend.)

Retains collet in nut for easier assembly.

Balancing

Ideal for high-speed applications.

Higher transferable torque

Lower frictional forces resulting in up to 80 % higher gripping force over standard non-treated clamping nuts.

Protection against corrosion

With a special treatment of the surface for longer life.

Optimal contour

Rounded thread start prevents damaging of collets on tool changes.

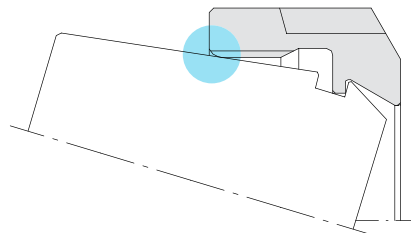

Swiss quality standard

Our products marked Swiss made are manufactured at our headquarters in Tenniken, Switzerland.

Highest quality standards for ER nuts

ER nuts



	Hi-Q®/ER	Hi-Q®/ERB	Hi-Q®/ERM	Hi-Q®/ERMx intrRlox®	Hi-Q®/ERAX	ER MS
Main feature	standard nut	with friction-bearing for higher clamping force	mini nut	slip-off proof mini nut	external thread and slip-off proof	up to 80,000 rpm
Sizes	ER 11 – ER 50	ER 16 – ER 50	ER 8 – ER 25	ER 8 – ER 25	ER 11 – ER 40	ER 8 – ER 20
Compatibility	compatible with all REGO-FIX ER collets					
Minimal outer diameter	–	–	•	•	•	–
Slip-off proof	–	–	–	•	•	–
Rust protection	•	•	•	•	•	–
Suitable wrench	A-E, E P, E, A-E P	A-E, E P, E, A-E P	A-E M, E M	A-E MX, E MX	A-E AX, E AX	A-E MS, E MS
More information on	page 114	page 118	page 120	page 122	page 126	page 124

A: external thread B: bearing M: mini thread X: slip-off proof

ER nuts Type C for wet machining



	Hi-Q®/ERC	Hi-Q®/ERBC	Hi-Q®/ERMC	Hi-Q®/ERMx intrRlox®	Hi-Q®/ERAXC
Main feature	standard nut	with friction-bearing for higher clamping force	mini nut	slip-off proof mini nut	external thread and slip-off proof
Cooling option	internal cooling with DS disks and peripheral cooling with KS disks to 150 bar				
Sizes	ER 11 – ER 50	ER 16 – ER 50	ER 8 – ER 25	ER 8 – ER 25	ER 11 – ER 40
Compatibility	compatible with all REGO-FIX ER collets, except PCM ET1 collets				
Minimal outer diameter	–	–	•	•	•
Slip-off proof	–	–	–	•	•
Rust protection	•	•	•	•	•
Suitable wrench	A-E, E P, E, A-E P	A-E, E P, E, A-E P	A-E M, E M	A-E MX, E MX	A-E AX, E AX
More information on	page 116	page 118	page 120	page 122	page 126

A: external thread B: bearing C: cooling M: mini thread X: slip-off proof

Proper assembly protects your runout TIR

High standards for all Hi-Q® / ER clamping nuts Hi-Q® / ER clamping nuts with corrosion-resistant surface are standard on all REGO-FIX ER colletholders.

Assembling collet Insert groove of the collet into eccentric ring of the clamping nut at the mark on the bottom of the nut. Push collet in the direction of the arrow until it clicks in. Insert tool. Screw nut with collet onto toolholder.

Removing collet After the nut is unscrewed from the toolholder, press on the face of the collet while simultaneously pushing sideways on the back of the collet opposite the mark until it disengages from the clamping nut.

Correct assembling Improper assembly can permanently damage the runout TIR of the collet and may result in the destruction of the clamping nut. Only mount nuts with correctly inserted collets. Never place the collet into the holder without first assembling into the nut.

We recommend the use of original REGO-FIX torque wrenches to prevent any damages to the ER nut.

For original REGO-FIX accessories, please refer to page 148.

Expert advice

Please only set back-up screw to the tool shank **after** clamping the tool. Disregarding this will result in bad run out and reduced clamping force.

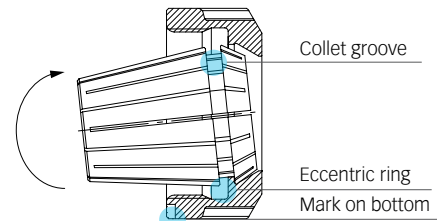

Assembling

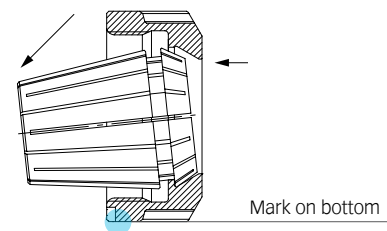

Disassembling

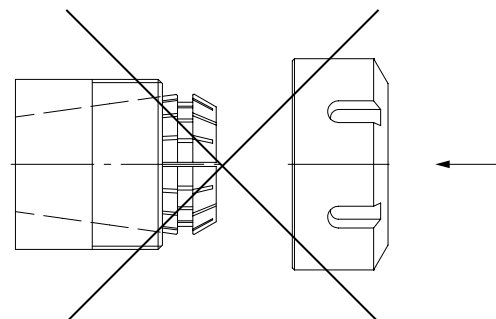

Hi-Q®/ER standard clamping nuts

Standard Hi-Q®/ER clamping nuts with corrosion-resistant surface are the standard nuts on all REGO-FIX ER colletholders.

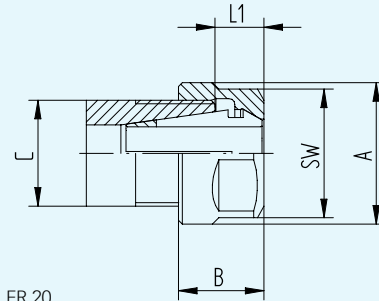

Hi-Q®/ER 11 – ER 20

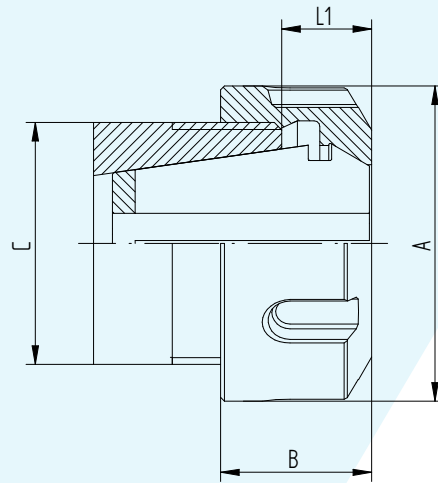

Hi-Q®/ER 25 – ER 50

Expert advice

Higher clamping force of the clamping nut at the same time means higher stress on the toolholder. We recommend the use of REGO-FIX torque wrench. REGO-FIX will not be responsible for damages to toolholders or spindles of other manufacturers.

Type	Part no.	Dimensions [mm]					Accessory	
		A	B	L1	SW	C	Wrench	
Hi-Q® / ER 11								
Hi-Q®/ER 11	3411.00000	19	11.3	4.9–6.6	17	M 14 x 0.75	7112.11010	
Hi-Q®/ER 11 L	3411.02000	19	11.3	4.9–6.6	17	M 14 x 0.75-LH	7112.11010	
Hi-Q® / ER 16								
Hi-Q®/ER 16	3416.00000	28	17.5	7.0–10.5	25	M 22 x 1.5	7112.16010	
Hi-Q®/ER 16 L	3416.02000	28	17.5	7.0–10.5	25	M 22 x 1.5-LH	7112.16010	
Hi-Q® / ER 20								
Hi-Q®/ER 20	3420.00000	34	19	8.0–11.5	30	M 25 x 1.5	7112.20010	
Hi-Q®/ER 20 L	3420.02000	34	19	8.0–11.5	30	M 25 x 1.5-LH	7112.20010	
Hi-Q® / ER 25								
Hi-Q®/ER 25	3425.00000	42	20	8.5–12.0	–	M 32 x 1.5	7111.25000	
Hi-Q®/ER 25 L	3425.02000	42	20	8.5–12.0	–	M 32 x 1.5-LH	7111.25000	
Hi-Q® / ER 32								
Hi-Q®/ER 32	3432.00000	50	22.5	9.5–13.0	–	M 40 x 1.5	7111.32000	
Hi-Q®/ER 32 L	3432.02000	50	22.5	9.5–13.0	–	M 40 x 1.5-LH	7111.32000	
Hi-Q® / ER 40								
Hi-Q®/ER 40	3440.00000	63	25.5	11.5–15.0	–	M 50 x 1.5	7111.40000	
Hi-Q®/ER 40 L	3440.02000	63	25.5	11.5–15.0	–	M 50 x 1.5-LH	7111.40000	
Hi-Q® / ER 50								
Hi-Q®/ER 50	3450.00000	78	35.3	14.0–21.0	–	M 64 x 2	7111.50000	

L: left-threaded nuts. Accessories are not included in delivery.

Expert advice

We recommend tightening the clamping nuts using a torque wrench.

For tightening torque recommendations, please refer to page 163.

Hi-Q®/ERC for coolant through tools

Application with sealing disk / coolant flush disk The Hi-Q®/ERC clamping nut is intended for use with the sealing disk system DS/ER and the cool flush system KS/ER. The disk system allows the use of all standard ER collets, ultraprecision collets and tapping collets for coolant through tools.

- // Up to 2100 PSI coolant pressure
- // Prevents dirt and chips from entering the collet

For peripheral cooling of non coolant through tools we recommend the coolant flush disks KS/ER. Please refer to page 142.

Hi-Q®/ERC 11 This clamping nut is recommended for use where minimal external diameters are important. The Hi-Q®/ERC 11 clamping nut for coolant through tools is the internal cooling version of the Hi-Q®/ER 11 clamping nut

Hi-Q®/ERC 11 does not require sealing disks The sealing system is built into the clamping nut.

- // Up to 2100 PSI coolant pressure
- // Prevents dirt and chips from entering the collet



Expert advice

We recommend tightening the clamping nuts using a torque wrench.

For tightening torque recommendations, please refer to page 163.

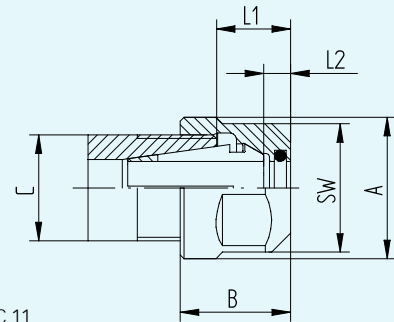

Hi-Q®/ERC 11

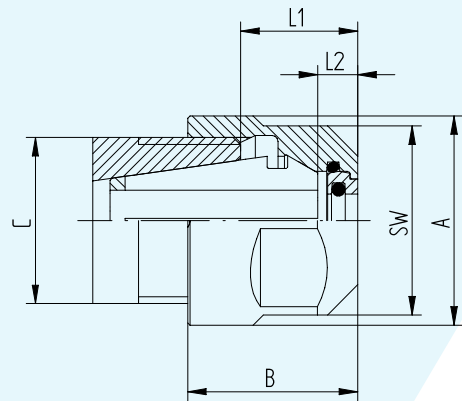

Hi-Q®/ERC 16 – ERC 20

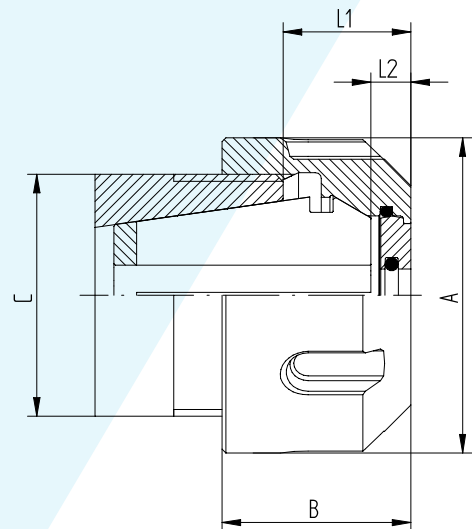

Hi-Q®/ERC 25 – ERC 50

Type	Part no.	Dimensions [mm]						C	Bore Ø		Accessory
		A	B	L1	L2	SW	[mm]		[inch]	Wrench	
Hi-Q® / ERC 11											
Hi-Q®/ERC 11, Ø 3.0 mm	3411.20300	19	–	8.1–9.8	3.5	17	M 14 x 0.75	3.0–2.5	3/32"	7112.11010	
Hi-Q®/ERC 11, Ø 3.5 mm	3411.20350	19	–	8.1–9.8	3.5	17	M 14 x 0.75	3.5–3.0	1/8"	7112.11010	
Hi-Q®/ERC 11, Ø 4.0 mm	3411.20400	19	–	8.1–9.8	3.5	17	M 14 x 0.75	4.0–3.5	5/32"	7112.11010	
Hi-Q®/ERC 11, Ø 4.5 mm	3411.20450	19	–	8.1–9.8	3.5	17	M 14 x 0.75	4.5–4.0	–	7112.11010	
Hi-Q®/ERC 11, Ø 5.0 mm	3411.20500	19	–	8.1–9.8	3.5	17	M 14 x 0.75	5.0–4.5	3/16"	7112.11010	
Hi-Q®/ERC 11, Ø 5.5 mm	3411.20550	19	–	8.1–9.8	3.5	17	M 14 x 0.75	5.5–5.0	7/32"	7112.11010	
Hi-Q®/ERC 11, Ø 6.0 mm	3411.20600	19	–	8.1–9.8	3.5	17	M 14 x 0.75	6.0–5.5	–	7112.11010	
Hi-Q®/ERC 11, Ø 6.5 mm	3411.20650	19	–	8.1–9.8	3.5	17	M 14 x 0.75	6.5–6.0	1/4"	7112.11010	
Hi-Q®/ERC 11, Ø 7.0 mm	3411.20700	19	–	8.1–9.8	3.5	17	M 14 x 0.75	7.0–6.5	–	7112.11010	
Hi-Q® / ERC 16											
Hi-Q®/ERC 16	3416.20000	–	28	12.0–15.5	5	25	M 22 x 1.5	22.5	–	7112.16010	
Hi-Q® / ERC 20											
Hi-Q®/ERC 20	3420.20000	–	34	13.0–16.5	5	30	M 25 x 1.5	24	–	7112.20010	
Hi-Q® / ERC 25											
Hi-Q®/ERC 25	3425.20000	–	42	13.5–17.0	5	–	M 32 x 1.5	25	–	7111.25000	
Hi-Q® / ERC 32											
Hi-Q®/ERC 32	3432.20000	–	50	14.5–18.0	5	–	M 40 x 1.5	27.5	–	7111.32000	
Hi-Q® / ERC 40											
Hi-Q®/ERC 40	3440.20000	–	63	16.5–20.0	5	–	M 50 x 1.5	30.5	–	7111.40000	
Hi-Q® / ERC 50											
Hi-Q®/ERC 50	3450.20000	–	78	19.0–26.0	5	–	M 64 x 2	40.3	–	7111.50000	

Accessories are not included in delivery.

Hi-Q®/ERB friction-bearing Hi-Q®/ERBC for coolant through tools

Application The Hi-Q®/ERB is a friction-bearing nut that offers the highest clamping force available. It is interchangeable with all other nuts per DIN 6499.

Application with sealing disk / coolant flush disk The Hi-Q®/ERBC clamping nut is intended for use with the sealing disk system DS/ER and the cool flush system KS/ER. The disk system allows the use of all standard ER collets, ultraprecision collets and tapping collets for coolant through tools.

- // Up to 2100 PSI coolant pressure
- // Prevents dirt and chips from entering the collet

For peripheral cooling of non coolant through tools we recommend the coolant flush disks KS/ER. Please refer to page 142.

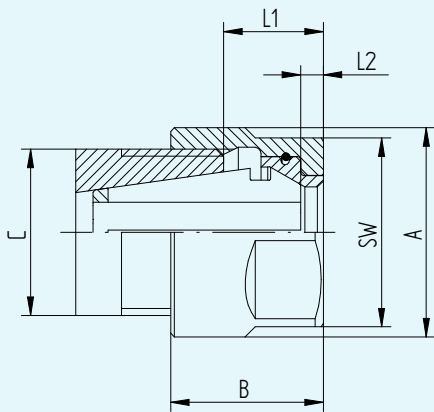

Hi-Q®/ERB 16 – ERB 20

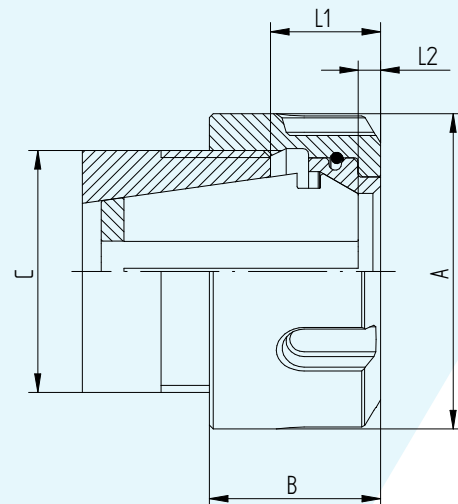

Hi-Q®/ERB 25 – ERB 50

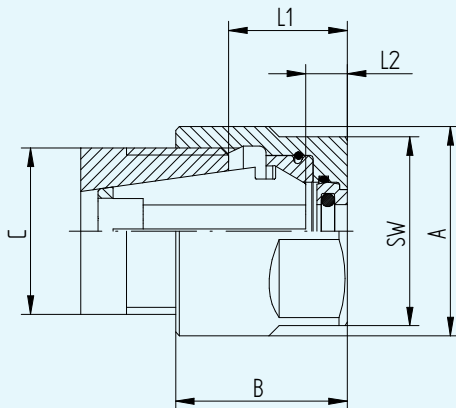

Hi-Q®/ERBC 16 – ERBC 20

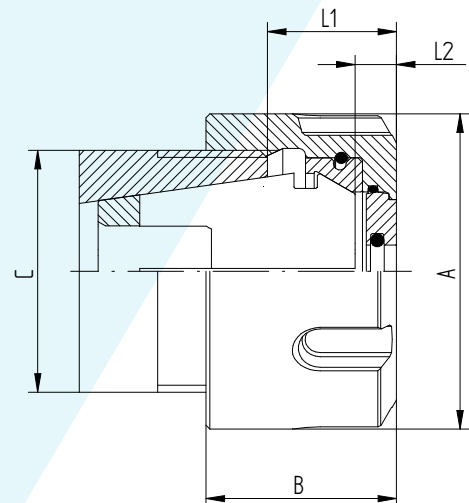

Hi-Q®/ERBC 25 – ERBC 50

Type	Part no.	Dimensions [mm]					C	Accessory
		A	B	L1	L2	SW		Wrench
Hi-Q® / ERB 16								
Hi-Q®/ERB 16	3416.30000	28	20.2	10.0–13.6	3	25	M 22 x 1.5	7112.16010
Hi-Q® / ERB 20								
Hi-Q®/ERB 20	3420.30000	34	21.7	11.0–14.5	3	30	M 25 x 1.5	7112.20010
Hi-Q® / ERB 25								
Hi-Q®/ERB 25	3425.30000	42	22.6	11.5–15.0	3	–	M 32 x 1.5	7111.25000
Hi-Q® / ERB 32								
Hi-Q®/ERB 32	3432.30000	50	25	12.5–16.0	3	–	M 40 x 1.5	7111.32000
Hi-Q® / ERB 40								
Hi-Q®/ERB 40	3440.30000	63	28.2	14.5–18.0	3	–	M 50 x 1.5	7111.40000
Hi-Q® / ERB 50								
Hi-Q®/ERB 50	3450.30000	78	38.1	17.0–24.0	3	–	M 64 x 2	7111.50000

Expert advice

We recommend tightening the clamping nuts using a torque wrench.
For tightening torque recommendations, please refer to page 163.

Type	Part no.	Dimensions [mm]					C	Accessory
		A	B	L1	L2	SW		Wrench
Hi-Q® / ERBC 16								
Hi-Q®/ERBC 16	3416.40000	28	22.7	12.5–16.0	5.5	25	M 22 x 1.5	7112.16010
Hi-Q® / ERBC 20								
Hi-Q®/ERBC 20	3420.40000	34	24	13.5–17.0	5.5	30	M 25 x 1.5	7112.20010
Hi-Q® / ERBC 25								
Hi-Q®/ERBC 25	3425.40000	42	25.2	14.0–17.5	5.5	–	M 32 x 1.5	7111.25000
Hi-Q® / ERBC 32								
Hi-Q®/ERBC 32	3432.40000	50	27.4	15.0–18.5	5.5	–	M 40 x 1.5	7111.32000
Hi-Q® / ERBC 40								
Hi-Q®/ERBC 40	3440.40000	63	30.7	17.0–20.5	5.5	–	M 50 x 1.5	7111.40000

Accessories are not included in delivery.

Hi-Q®/ERM minimal external diameter Hi-Q®/ERMC for coolant through tools

Application The mini clamping nut Hi-Q®/ERM is recommended for use where minimal external diameters are essential (e.g., machining space is very limited). Thus, it is ideally suitable for multispindle drilling heads and collet-holder extensions. The corresponding wrenches have the same external dimensions as the clamping nuts.

Application with sealing disk / coolant flush disk The Hi-Q®/ERMC clamping nut is intended for use with the sealing disk system DS/ER and the cool flush system KS/ER. The disk system allows the use of all standard ER collets, ultraprecision collets and tapping collets for coolant through tools.

- // Up to 2100 PSI coolant pressure
- // Prevents dirt and chips from entering the collet

For peripheral cooling of non coolant through tools we recommend the coolant flush disks KS/ER. Please refer to page 142.

Hi-Q®/ERMC 11 This clamping nut is recommended for use where minimal external diameters are important. It is the coolant through tools version of the Hi-Q®/ERM 11 clamping nut.

Hi-Q®/ERM 11 does not require sealing disks The sealing system is built into the clamping nut.

- // Up to 2100 PSI coolant pressure
- // Prevents dirt and chips from entering the collet
- // Not interchangeable with nuts according to DIN 6499/ISO 15488

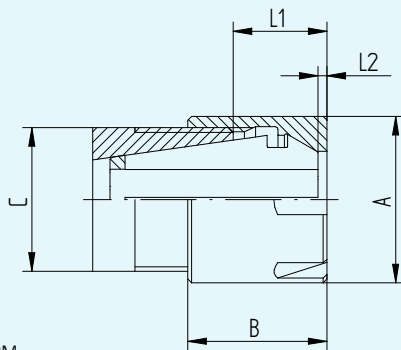

Hi-Q®/ERM

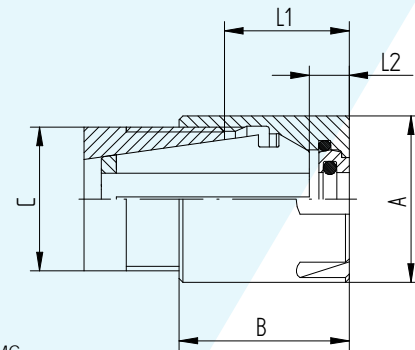

Hi-Q®/ERMC

Expert advice

We recommend tightening the clamping nuts using our torque wrench.

For tightening torque recommendations, please refer to page 163.

Type	Part no.	Dimensions [mm]				C	Bore Ø		Accessory
		A	B	L1	L2		[inch]	[mm]	Wrench
Hi-Q® / ERM 8									
Hi-Q®/ERM 8	3508.00000	12	10.8	4.3–6.1	1.5	M 10 x 0.75	–	–	7113.08000
Hi-Q®/ERM 8 L	3508.02000	12	10.8	4.3–6.1	1.5	M 10 x 0.75-LH	–	–	7113.08000
Hi-Q® / ERM 11									
Hi-Q®/ERM 11	3511.00000	16	12	5.7–7.5	0.4	M 13 x 0.75	–	–	7113.11000
Hi-Q®/ERM 11 L	3511.02000	16	12	5.7–7.5	0.4	M 13 x 0.75-LH	–	–	7113.11000
Hi-Q® / ERM 16									
Hi-Q®/ERM 16	3516.00000	22	18.4	8.0–11.5	0.9	M 19 x 1	–	–	7113.16000
Hi-Q®/ERM 16 L	3516.02000	22	18.4	8.0–11.5	0.9	M 19 x 1-LH	–	–	7113.16000
Hi-Q® / ERM 20									
Hi-Q®/ERM 20	3520.00000	28	19	8.0–11.5	–	M 24 x 1	–	–	7113.20000
Hi-Q®/ERM 20 L	3520.02000	28	19	8.0–11.5	–	M 24 x 1-LH	–	–	7113.20000
Hi-Q® / ERM 25									
Hi-Q®/ERM 25	3525.00000	35	20	8.5–12.0	–	M 30 x 1	–	–	7113.25000
Hi-Q®/ERM 25 L	3525.02000	35	20	8.5–12.0	–	M 30 x 1-LH	–	–	7113.25000

Type	Part no.	Dimensions [mm]				C	Bore Ø		Accessory
		A	B	L1	L2		[mm]	[inch]	Wrench
Hi-Q® / ERMC 11									
Hi-Q®/ERMC 11, Ø 3.0 mm	3511.20300	16	14.6	8.1–9.8	3.5	M 13 x 0.75	3.0–2.5	3/32"	7113.11000
Hi-Q®/ERMC 11, Ø 3.5 mm	3511.20350	16	14.6	8.1–9.8	3.5	M 13 x 0.75	3.5–3.0	1/8"	7113.11000
Hi-Q®/ERMC 11, Ø 4.0 mm	3511.20400	16	14.6	8.1–9.8	3.5	M 13 x 0.75	4.0–3.5	5/32"	7113.11000
Hi-Q®/ERMC 11, Ø 4.5 mm	3511.20450	16	14.6	8.1–9.8	3.5	M 13 x 0.75	4.5–4.0	–	7113.11000
Hi-Q®/ERMC 11, Ø 5.0 mm	3511.20500	16	14.6	8.1–9.8	3.5	M 13 x 0.75	5.0–4.5	3/16"	7113.11000
Hi-Q®/ERMC 11, Ø 5.5 mm	3511.20550	16	14.6	8.1–9.8	3.5	M 13 x 0.75	5.5–5.0	7/32"	7113.11000
Hi-Q®/ERMC 11, Ø 6.0 mm	3511.20600	16	14.6	8.1–9.8	3.5	M 13 x 0.75	6.0–5.5	–	7113.11000
Hi-Q®/ERMC 11, Ø 6.5 mm	3511.20650	16	14.6	8.1–9.8	3.5	M 13 x 0.75	6.5–6.0	1/4"	7113.11000
Hi-Q®/ERMC 11, Ø 7.0 mm	3511.20700	16	14.6	8.1–9.8	3.5	M 13 x 0.75	7.0–6.5	–	7113.11000
Hi-Q® / ERMC 16									
Hi-Q®/ERMC 16	3516.20000	22	22	11.5–15.0	4.5	M 19 x 1	–	–	7113.16000
Hi-Q® / ERMC 20									
Hi-Q®/ERMC 20	3520.20000	28	24	13–16.5	5	M 24 x 1	–	–	7113.20000
Hi-Q® / ERMC 25									
Hi-Q®/ERMC 25	3525.20000	35	25	13.5–17.0	5	M 30 x 1	–	–	7113.25000

L: left-threaded nuts. Accessories are not included in delivery.

Hi-Q®/ERMX and Hi-Q®/ERMXC intRlox® Slip-off proof mini clamping nuts

Application

For REGO-FIX ER colletholders with mini thread and cylindrical holders.

Key advantages

- // Design is ideally suited for lathes and Swiss turning machines
- // Very slim sizing proofs suitable for machines where space is limited
- // Safe handling thanks to the patented intRlox® profile
- // Slip-off proof design with all advantages of the regular mini clamping nuts
- // Easy and safe clamping with the MX wrench

Application with sealing disk / coolant flush disk The Hi-Q®/ERMXC clamping nut is intended for use with the sealing disk system DS/ER and the coolant flush system KS/ER. The disk system allows the use of all standard ER collets, ultraprecision collets and tapping collets for coolant through tools.

- // Up to 2100 PSI coolant pressure
- // Prevents dirt and chips from entering the collet

For peripheral cooling of non coolant through tools we recommend the coolant flush disks KS/ER. Please refer to page 142.



Hi-Q®/ERMX

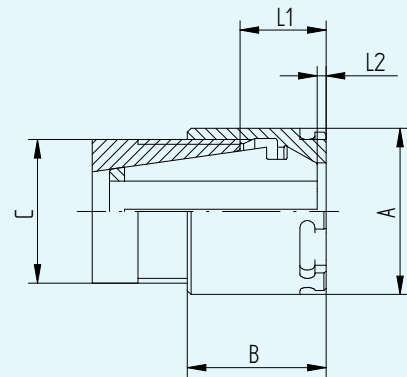

Hi-Q®/ERMX



Hi-Q®/ERMXC

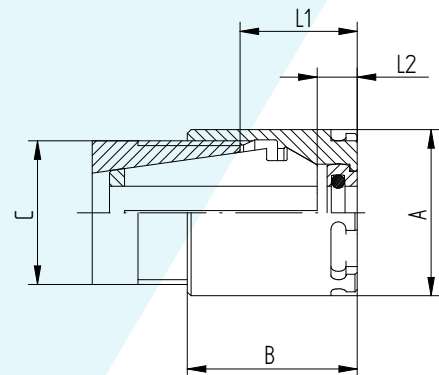

Hi-Q®/ERMXC

Hi-Q®/ERMX intRlox®

Hi-Q®/ERMXC intRlox®

ERMX

ERMXC

Type	Part no.	Dimensions [mm]					C	Accessory
		A	B	L1	L2	Wrench		
Hi-Q® / ERMX 8								
Hi-Q®/ERMX 8	3508.60000	16	12	4.3–6.1	0.4	M 10 x 0.75	7118.08000	
Hi-Q® / ERMX 11								
Hi-Q®/ERMX 11	3511.60000	16	12	5.7–7.5	0.4	M 13 x 0.75	7118.11000	
Hi-Q® / ERMX 16								
Hi-Q®/ERMX 16	3516.60000	22	18.4	8.0–11.5	0.9	M 19 x 1	7118.16000	
Hi-Q® / ERMX 20								
Hi-Q®/ERMX 20	3520.60000	28	19	8.0–11.5	–	M 24 x 1	7118.20000	
Hi-Q® / ERMX 25								
Hi-Q®/ERMX 25	3525.60000	35	20	8.5–12.0	–	M 30 x 1	7118.25000	

Type	Part no.	Dimensions [mm]					C	Accessory
		A	B	L1	L2	Wrench		
Hi-Q® / ERMXC 16								
Hi-Q®/ERMXC 16	3516.70000	22	22	11.5–15.0	4.5	M 19 x 1	7118.16000	
Hi-Q® / ERMXC 20								
Hi-Q®/ERMXC 20	3520.70000	28	24	13.0–16.5	5	M 24 x 1	7118.20000	
Hi-Q® / ERMXC 25								
Hi-Q®/ERMXC 25	3525.70000	35	25	13.0–17.0	5	M 30 x 1	7118.25000	

Accessories are not included in delivery.

Expert advice

We recommend tightening the clamping nuts using our torque wrench.
We also recommend to use our REGO-FIX wrench heads and wrenches.

For tightening torque recommendations, please refer to page 163.

For matching wrenches and wrench heads, please refer to page 150.

ER MS clamping nuts for highest RPM

Application The ER MS clamping nut for highest RPM with minimal external diameter does not have the collet-locking system and all the contours are ground. This provides best balancing for critical high-speed machining applications.

The collet is released with the corresponding E MS wrench. ER MS nuts are also interchangeable with the Hi-Q®/ERM and Hi-Q®/ERMC nuts. With the ER MS clamping nuts we recommend using ER-UP (ultra-precision) collets to achieve the highest runout TIR.

Key advantages

- // Precision-machined contours on all sides
- // Minimal residual unbalance
- // For high rpm up to 80,000

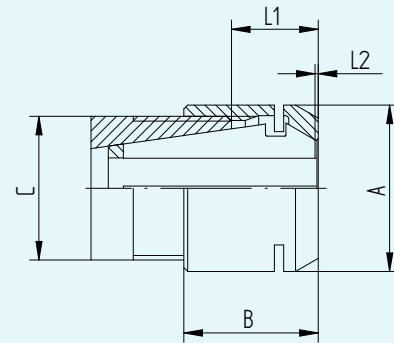

ER MS

Type	Part no.	Dimensions [mm]				C	Accessory
		A	B	L1	L2		Wrench
ER 8 MS							
ER 8 MS	3208.50000	12	10.8	4.3–6.1	1.5	M 10 x 0.75	7114.08000
ER 11 MS							
ER 11 MS	3211.50000	16	11.5	4.6–6.8	0.4	M 13 x 0.75	7114.11000
ER 16 MS							
ER 16 MS	3216.50000	22	17.8	6.1–10.5	0.3	M 19 x 1	7114.16000
ER 20 MS							
ER 20 MS	3220.50000	28	19	7.1–11.5	0.3	M 24 x 1	7114.20000

Accessories are not included in delivery.

Hi-Q® / ERAX with external thread Hi-Q® / ERAXC for coolant through tools

Application For REGO-FIX floating chucks and other ER colletholders with internal thread, e.g., ERA holders. These nuts can also be used on driven tools with internal threads.

Please refer to page 22 for the CAT / ERA Zero-Z® colletholder.

Please refer to page 28 for the SK / ERA Zero-Z® colletholder.

Please refer to page 34 for BT / ERA Zero-Z® colletholder.

Key advantages

- // Space-saving design for ideal use on long-turning machines
- // S-profile wrench is self-centering on the nut and prevents slipping off while tightening the nut

Application with sealing disk / coolant flush disk The Hi-Q® / ERAXC clamping nut is intended for use with the sealing disk system DS / ER and the coolant flush system KS / ER.

The disk system allows the use of all standard ER collets, ultraprecision collets and tapping collets for coolant through tools.

- // Up to 2100 PSI coolant pressure
- // Prevents dirt and chips from entering the collet

For peripheral cooling of non coolant through tools we recommend the coolant flush disks KS / ER. Please refer to page 142.

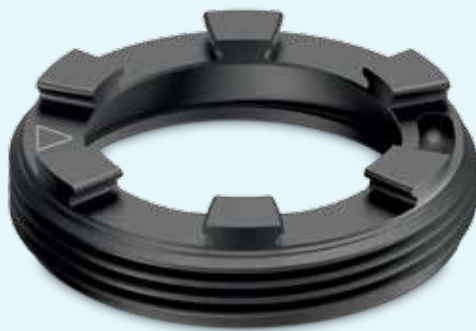

Hi-Q® / ERAX



Hi-Q® / ERAXC

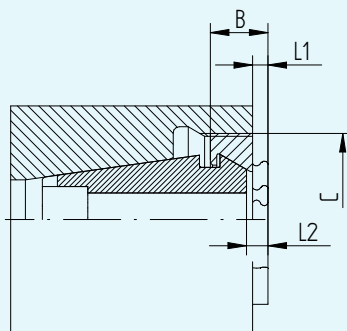

Hi-Q® / ERAX

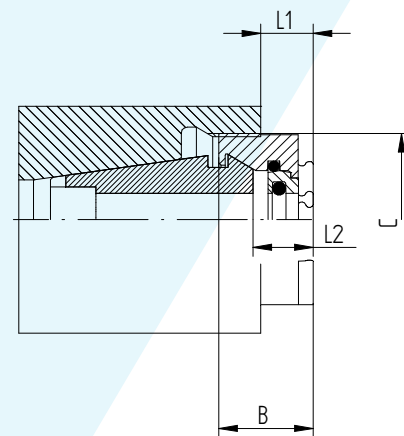

Hi-Q® / ERAXC

Hi-Q®/ERAX

Hi-Q®/ERAXC

ERAX

ERAXC

Type	Part no.	Dimensions [mm]			C	Accessory
		B	L1	L2		Wrench
Hi-Q® / ERAX 11						
Hi-Q®/ERAX 11	3311.60000	7.5	1.0–3.2	3.9	M 18 x 1	7117.11000
Hi-Q® / ERAX 16						
Hi-Q®/ERAX 16	3316.60000	7.6	0–2.6	2.3	M 24 x 1	7117.16000
Hi-Q® / ERAX 20						
Hi-Q®/ERAX 20	3320.60000	8.5	0–2.5	2.3	M 28 x 1.5	7117.20000
Hi-Q® / ERAX 25						
Hi-Q®/ERAX 25	3325.60000	8.8	0–1.9	2.3	M 32 x 1.5	7117.25000
Hi-Q® / ERAX 32						
Hi-Q®/ERAX 32	3332.60000	9.8	0–1.1	2.5	M 40 x 1.5	7117.32000
Hi-Q® / ERAX 40						
Hi-Q®/ERAX 40	3340.60000	11.7	0–1.0	2.4	M 50 x 1.5	7117.40000

Type	Part no.	Dimensions [mm]			C	Accessory
		B	L1	L2		Wrench
Hi-Q® / ERAXC 16						
Hi-Q®/ERAXC 16	3316.70000	12.5	3.1–7.5	7.2	M 24 x 1	7117.16000
Hi-Q® / ERAXC 20						
Hi-Q®/ERAXC 20	3320.70000	13.5	3.1–7.5	7.3	M 28 x 1.5	7117.20000
Hi-Q® / ERAXC 25						
Hi-Q®/ERAXC 25	3325.70000	13.8	2.5–6.9	7.3	M 32 x 1.5	7117.25000
Hi-Q® / ERAXC 32						
Hi-Q®/ERAXC 32	3332.70000	14.9	1.8–6.2	7.6	M 40 x 1.5	7117.32000
Hi-Q® / ERAXC 40						
Hi-Q®/ERAXC 40	3340.70000	16.6	1.5–5.9	7.3	M 50 x 1.5	7117.40000

Accessories are not included in delivery.

Retrofit driven tools and turning machines to internal cooling with reCool®



Retrofitted internal cooling with reCool®

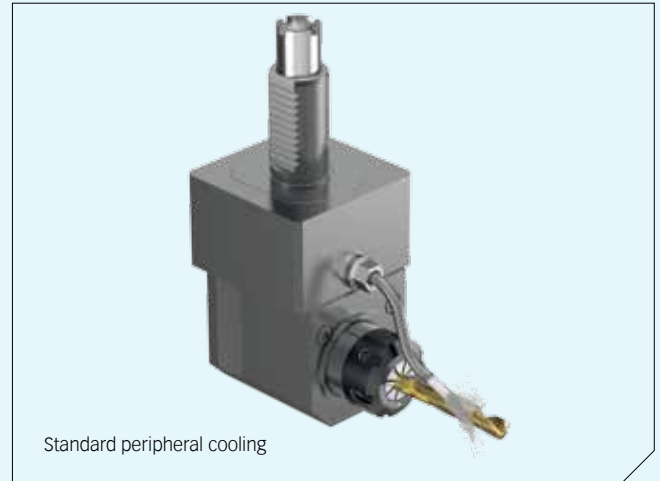

Standard peripheral cooling

Key features of reCool® rotary RCR for use with spindles

- // Cost-friendly conversion of existing tooling systems to through coolant in only two minutes
- // For ER and ERM nuts in driven tools and turning machines and for ER collets to ISO 15488 / DIN 6499
- // Speeds up to 12,000 rpm*
- // Coolant pressures up to 800 PSI in RCR / ER**
- // Maintenance-free coolant lubricated bearings
- // For coolant through tools (with sealing disks DS) and for peripheral cooling (with coolant flush disks KS)
- // RCR/ER for emulsion coolants and RCR/ERM for emulsion and oil coolants
- // Convert inner-threaded driven tools to outer-threaded, using the reCool® adapter. Thus, successfully prepare different types of driven tooling for the use of reCool®
- // RCR/ERM with intrRlox nut design for safety
- // Not for use with sealed collets

* 6,000 rpm with RCR / ER 40.

** Coolant pressures up to 1400 or 2100 PSI for RCR/ERM.

Expert advice

reCool® RCR is designed for standard covered machines due to the constant loss of coolant of the wet-bearing system. The amount of coolant loss may be influenced and enlarged due to pressure, throughput, viscosity, RPM, tool length and tool diameter.

Please contact your REGO-FIX specialist to learn more about working with reCool®.

Type	Part no.	Dimensions [mm]		Thread	Accessory	Included in set RCR	
		B	D		Wrench	Type	Qty.
Set RCR / ER (for emulsion based coolants)						RCR / ER 16 – 40	1
SET RCR / ER 16	3716.00000	24.5	34	M 22 x 1.5	7117.16000	SET RHS	1
SET RCR / ER 20	3720.00000	26	40	M 25 x 1.5	7117.20000	SET RVG 1/8" – 0°	2
SET RCR / ER 25	3725.00000	27	50	M 32 x 1.5	7117.25000	SET RVA 1/8" – 90°	2
SET RCR / ER 32	3732.00000	29.5	62.5	M 40 x 1.5	7117.32000		
SET RCR / ER 40	3740.00000	32.5	72.5	M 50 x 1.5	7117.40000		

Accessories are not included in delivery.

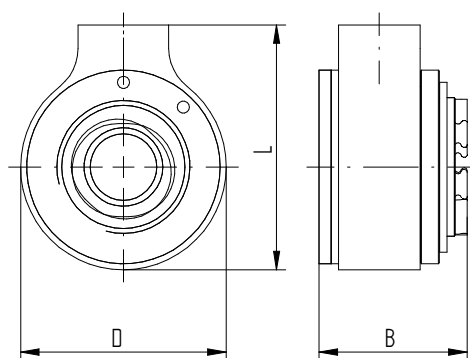

RCR / ER



SET RCR / ERM

Type	Part no.	Dimensions [mm]		Thread	Accessory	Included in set RCR/ERM	
		B	D		Wrench	Type	Qty.
Set RCR / ERM (for emulsion and oil based coolants)						RCR / ERM 16 – 25	1
SET RCR / ERM 16	3716.30000	24.5	31	M 19 x 1	7117.16000	SET RHS	1
SET RCR / ERM 20	3720.30000	26	38	M 24 x 1	7117.20000	SET RVG-100 1/8" – 0°	2
SET RCR / ERM 25	3725.30000	27	46	M 30 x 1	7117.25000	SET RVA-100 1/8" – 90°	2

RCR / ERM nut

RCR / ERM 16	3716.39000	24.5	31	M 29 x 1	7117.16000
RCR / ERM 20	3720.39000	26	38	M 24 x 1	7117.20000
RCR / ERM 25	3725.39000	27	46	M 30 x 1	7117.25000

Accessories are not included in delivery.

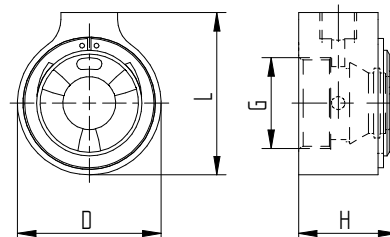

RCR / ERM

Fast and easy retrofitting: From external flood cooling to internal cooling



Retrofitted internal cooling with reCool®

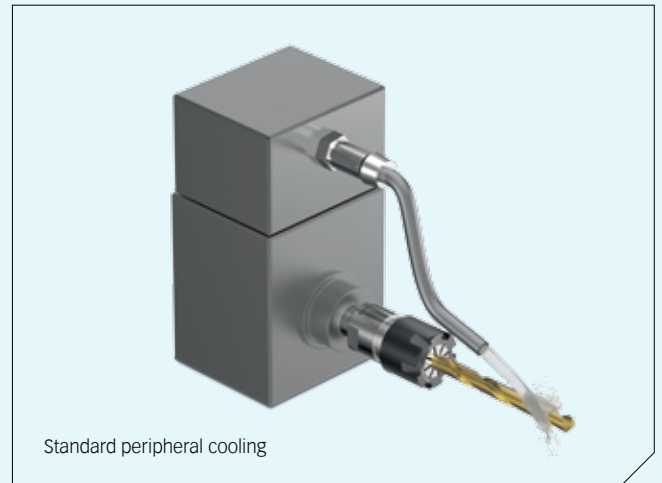

Standard peripheral cooling

Key features of reCool® static RCS for use with static holders

- // Cost-friendly conversion of existing tooling systems to through coolant in only two minutes
 - // For ER collets (DIN 6499 / ISO 15488) in stationary collet holders with external fine threads*
 - // Coolant pressures of up to 2100 PSI**
 - // Speeds of up to 12,000 rpm
 - // RCS / ERMX for emulsion and oil coolants
 - // Low-maintenance design
 - // For coolant through tools (with sealing disks DS) and for peripheral cooling (with coolant flush disks KS)
 - // intRlox (ERMX) nut design for safety
- * reCool® static can also be used for internal threading with the corresponding adapter.
- ** With high-pressure hoses RHS-HP. 100 bar/1450 psi with standard hose.

Advantages of internal cooling with reCool®

- // Optimum coolant supply for all tools, also for difficult to access machining
- // No scattering or spray losses
- // Optimized coolant quantity for each tool
- // Increased chip removal
- // Directs coolant straight to cutting tool

Disadvantages of standard peripheral cooling

- // Limited adjustment of the nozzles or spray tubes with different tool lengths and diameters
- // Reduction of tool life since coolant is not led directly to the cutting edge
- // Scattering losses of the spray jet
- // Poor chip removal

Type	Part no.	Dimensions [mm]			Thread	Accessory Wrench	Included in set RCS	
		B	D				Type	Qty.
Set RCS (for emulsion and oil based coolants)							SET RCS/ERMX 16/20	1
SET RCS/ERMX 16	3716.50000	22.5	27.5	M 19 x 1	7118.16000	SET RHS-100	1	
SET RCS/ERMX 20	3720.50000	24	34.5	M 24 x 1	7118.20000	SET RVG-100 1/8" - 0°	2	
						SET RVA-100 1/8" - 90°	2	
RCS/ERMX nut								
RCS/ERMX 16	3716.59000	22.5	27.5	M 19 x 1	7118.16000			
RCS/ERMX 20	3720.59000	24	34.5	M 24 x 1	7118.20000			

Accessories are not included in delivery.

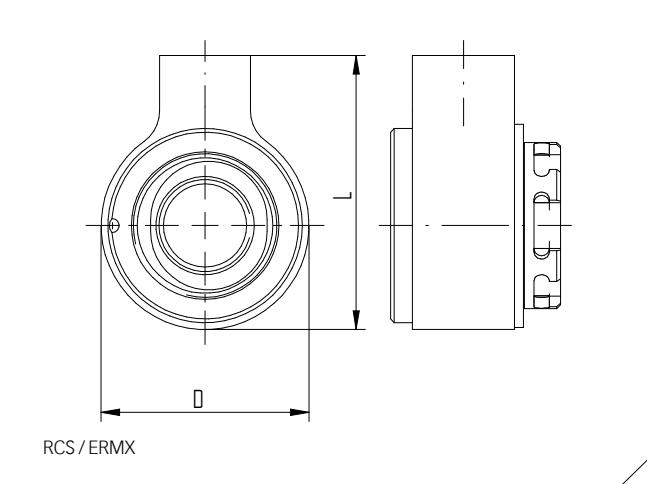

Expert advice

For wrench heads please refer to page 153. For the matching slip-off proof extensions please refer to page 152.

Matching accessories for your reCool®

Type	Part no.	Dimensions [mm]		Thread G1	Thread G2
		d	L		
reCool® adapters exclusive for RCR / ER					
RC-ADP 16	3799.81600	16	8.7	M 24 x 1	M 22 x 1.5
RC-ADP 20	3799.82000	20	8.2	M 28 x 1.5	M 25 x 1.5
RC-ADP 25	3799.82500	25	7.9	M 32 x 1.5	M 32 x 1.5
RC-ADP 32	3799.83200	32	8.7	M 40 x 1.5	M 40 x 1.5
RC-ADP 40	3799.84000	40	9.6	M 50 x 1.5	M 50 x 1.5

reCool® adapter The reCool® adapter RC-ADP easily converts inner-threaded driven tools to outer-threaded ones which enables the use of the reCool® rotary coolant supply system RCR with different types of driven tooling.

How to use? Just screw the adapter with advised tightening torque into the driven tool, use the correctly installed reCool® rotary coolant supply system RCR and clamp the tool.

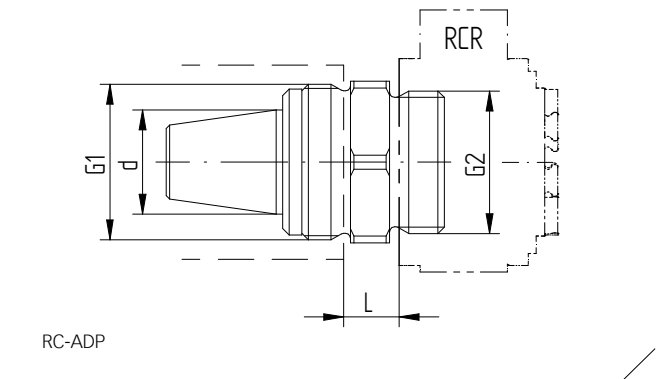

Expert advice

reCool® is only applicable with the use of our sealing DS/ER and Coolant flush disks KS/ER. Please note, that neither DS/ER nor KS/ER are included in the reCool® sets.

Please refer to page 134 for sealing disks and to page 142 for Coolant flush disks.

Type	Part no.	Length [mm]
High-pressure hoses (≤ 150 bar) with threaded 1/8" ends		
RHS-HP L100	3799.97100	100
RHS-HP L200	3799.97200	200
RHS-HP L300	3799.97300	300
RHS-HP L400	3799.97400	400

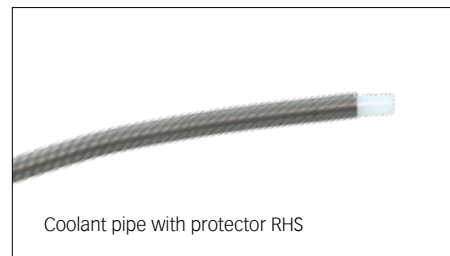

Coolant pipe with protector (≤ 100 bar)		
SET RHS-100	3799.95000	-

Coolant pipe with protector exclusive for RCR/ER		
SET RHS	3799.91000	-



Straight fitting (≤ 100 bar)		
SET RVG-100 1/8" -0°	3799.96180	-

Straight fittings exclusive for RCR/ER		
SET RVG M8 x 1 -0°	3799.92810	-
SET RVG 1/8" -0°	3799.92180	-

90° elbow fitting (≤ 100 bar)		
SET RVA-100 1/8" -90°	3799.96189	-



90° elbow fitting exclusive for RCR/ER		
RVA 1/8" -90°	3799.92189	-

Ball adapters 1/8" BSP		
RBA 10, 10.0 mm	3799.93100	-
RBA 11, 11.0 mm	3799.93110	-
RBA 12, 12.0 mm	3799.93120	-
RBA 13, 13.0 mm	3799.93130	-
RBA 14, 14.0 mm	3799.93140	-
RBA 15, 15.0 mm	3799.93150	-
RBA 16, 16.0 mm	3799.93160	-



Aluminum ring adapters 1/8" BSP		
RRA 10, 10.0 mm	3799.94100	-
RRA 11, 11.0 mm	3799.94110	-
RRA 12, 12.0 mm	3799.94120	-
RRA 13, 13.0 mm	3799.94130	-
RRA 14, 14.0 mm	3799.94140	-
RRA 15, 15.0 mm	3799.94150	-
RRA 16, 16.0 mm	3799.94160	-



Affordable solution for internal cooling

Our sealing disks allow you to use your regular non-sealed collet for internal cooling, saving you acquisition costs for new collets.

Key advantages

Swiss quality disks

Sealing range

0.5 mm

High pressure

For applications up to 2100 PSI.

Protection

Protects against all kind of dirt and chips entering the slots of the collet.

Matched tooling system for best fit

Our long-lasting machining experience results in a well-engineered system. All components are fitted together to one system to maximize your machining potential.

Coolant resistant

O-ring for aggressive coolant (MITON®-quality).

Interchangeable

Quick change of sealing disks according to required tool shank diameter.

Coolant through

For better cooling and lubrication. Extends tool life and supports chip removal.

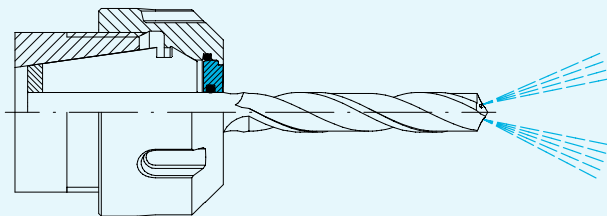

DS/ER

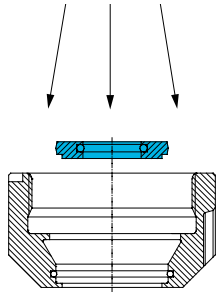

Assembling

Assembling Insert the small diameter of the disk into the center of the coolant nut. Apply an even pressure until the disk is properly seated into the nut.

The disk must be flush with the outside of the nut and the marking on the disk must be seen inside the nut.

Removing To remove the disk, simply press on the outside of the disk evenly until it snaps out.

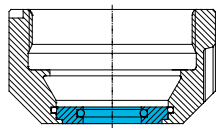

Inserted DS / ER

Expert advice

Insert tool with the shank side first. O-ring might be damaged if cutting tool is inserted from the back with the cutting edge side.

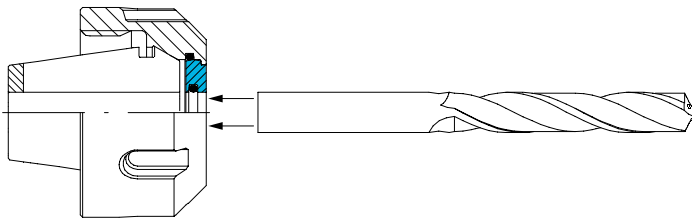

Insert tool

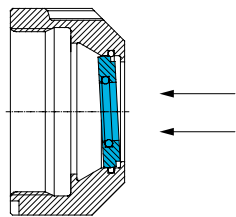

Disk removal

Type	Part no.	Ø [inch]	Bore Ø		Incl. in set
			[mm]	[inch]	
DS / ER 16					
DS / ER 16 SET (14 Stk./ pcs.)	3916.00000	–	3.0–10.0	0.1378–0.3937	–
Ø 3.0 mm	3916.00300	3/32"	3.0–2.5	0.1181–0.0984	–
Ø 3.5 mm	3916.00350	1/8"	3.5–3.0	0.1378–0.1181	•
Ø 4.0 mm	3916.00400	5/32"	4.0–3.5	0.1575–0.1378	•
Ø 4.5 mm	3916.00450	–	4.5–4.0	0.1772–0.1575	•
Ø 5.0 mm	3916.00500	3/16"	5.0–4.5	0.1969–0.1772	•
Ø 5.5 mm	3916.00550	7/32"	5.5–5.0	0.2165–0.1969	•
Ø 6.0 mm	3916.00600	–	6.0–5.5	0.2362–0.2165	•
Ø 6.5 mm	3916.00650	1/4"	6.5–6.0	0.2559–0.2362	•
Ø 7.0 mm	3916.00700	–	7.0–6.5	0.2756–0.2559	•
Ø 7.5 mm	3916.00750	9/32"	7.5–7.0	0.2953–0.2756	•
Ø 8.0 mm	3916.00800	5/16"	8.0–7.5	0.315–0.2953	•
Ø 8.5 mm	3916.00850	–	8.5–8.0	0.3346–0.315	•
Ø 9.0 mm	3916.00900	11/32"	9.0–8.5	0.3543–0.3346	•
Ø 9.5 mm	3916.00950	3/8"	9.5–9.0	0.374–0.3543	•
Ø 10.0 mm	3916.01000	–	10.0–9.5	0.3937–0.374	•
DS / ER 20					
SET DS / ER 20 (20 Stk./ pcs.)	3920.00000	–	3.0–13.0	0.1378–0.5118	–
Ø 3.0 mm	3920.00300	3/32"	3.0–2.5	0.1181–0.0984	–
Ø 3.5 mm	3920.00350	1/8"	3.5–3.0	0.1378–0.1181	•
Ø 4.0 mm	3920.00400	5/32"	4.0–3.5	0.1575–0.1378	•
Ø 4.5 mm	3920.00450	–	4.5–4.0	0.2165–0.1969	•
Ø 5.0 mm	3920.00500	3/16"	5.0–4.5	0.1969–0.1772	•
Ø 5.5 mm	3920.00550	7/32"	5.5–5.0	0.1772–0.1575	•
Ø 6.0 mm	3920.00600	–	6.0–5.5	0.2362–0.2165	•
Ø 6.5 mm	3920.00650	1/4"	6.5–6.0	0.2559–0.2362	•
Ø 7.0 mm	3920.00700	–	7.0–6.5	0.2756–0.2559	•
Ø 7.5 mm	3920.00750	9/32"	7.5–7.0	0.2953–0.2756	•
Ø 8.0 mm	3920.00800	5/16"	8.0–7.5	0.315–0.2953	•
Ø 8.5 mm	3920.00850	–	8.5–8.0	0.3346–0.315	•
Ø 9.0 mm	3920.00900	11/32"	9.0–8.5	0.3543–0.3346	•
Ø 9.5 mm	3920.00950	3/8"	9.5–9.0	0.374–0.3543	•
Ø 10.0 mm	3920.01000	–	10.0–9.5	0.3937–0.374	•
Ø 10.5 mm	3920.01050	13/32"	10.5–10.0	0.4134–0.3937	•
Ø 11.0 mm	3920.01100	–	11.0–10.5	0.433–0.4134	•
Ø 11.5 mm	3920.01150	7/16"	11.5–11.0	0.4528–0.4331	•
Ø 12.0 mm	3920.01200	15/32"	12.0–11.5	0.4724–0.4528	•
Ø 12.5 mm	3920.01250	–	12.5–12.0	0.4921–0.4724	•
Ø 13.0 mm	3920.01300	1/2"	13.0–12.5	0.5118–0.4921	•

Type	Part no.	Ø [inch]	Bore Ø		Incl. in set
			[mm]	[inch]	
DS / ER 25					
SET DS / ER 25 (26 Stk. / pcs.)	3925.00000	–	3.0–16.0	0.1181–0.6299	–
Ø 3.0 mm	3925.00300	3/32"	3.0–2.5	0.1181–0.0984	–
Ø 3.5 mm	3925.00350	1/8"	3.5–3.0	0.1378–0.1181	•
Ø 4.0 mm	3925.00400	5/32"	4.0–3.5	0.1575–0.1378	•
Ø 4.5 mm	3925.00450	–	4.5–4.0	0.1772–0.1575	•
Ø 5.0 mm	3925.00500	3/16"	5.0–4.5	0.1969–0.1772	•
Ø 5.5 mm	3925.00550	7/32"	5.5–5.0	0.2165–0.1969	•
Ø 6.0 mm	3925.00600	–	6.0–5.5	0.2362–0.2165	•
Ø 6.5 mm	3925.00650	1/4"	6.5–6.0	0.2559–0.2362	•
Ø 7.0 mm	3925.00700	–	7.0–6.5	0.2756–0.2559	•
Ø 7.5 mm	3925.00750	9/32"	7.5–7.0	0.2953–0.2756	•
Ø 8.0 mm	3925.00800	5/16"	8.0–7.5	0.315–0.2953	•
Ø 8.5 mm	3925.00850	–	8.5–8.0	0.3346–0.315	•
Ø 9.0 mm	3925.00900	11/32"	9.0–8.5	0.3543–0.3347	•
Ø 9.5 mm	3925.00950	3/8"	9.5–9.0	0.374–0.3543	•
Ø 10.0 mm	3925.01000	–	10.0–9.5	0.3937–0.374	•
Ø 10.5 mm	3925.01050	13/32"	10.5–10.0	0.4134–0.3937	•
Ø 11.0 mm	3925.01100	–	11.0–10.5	0.433–0.4134	•
Ø 11.5 mm	3925.01150	7/16"	11.5–11.0	0.4528–0.433	•
Ø 12.0 mm	3925.01200	15/32"	12.0–11.5	0.4724–0.4528	•
Ø 12.5 mm	3925.01250	–	12.5–12.0	0.4921–0.4724	•
Ø 13.0 mm	3925.01300	1/2"	13.0–12.5	0.2118–0.4921	•
Ø 13.5 mm	3925.01350	17/32"	13.5–13.0	0.5315–0.5118	•
Ø 14.0 mm	3925.01400	–	14.0–13.5	0.5512–0.5315	•
Ø 14.5 mm	3925.01450	9/16"	14.5–14.0	0.5709–0.5512	•
Ø 15.0 mm	3925.01500	–	15.0–14.5	0.5906–0.5709	•
Ø 15.5 mm	3925.01550	19/32"	15.5–15.0	0.6102–0.5906	•
Ø 16.0 mm	3925.01600	5/8"	16.0–15.5	0.6299–0.6102	•

Included in the DS/ER sets are all marked disks within that ER size and the matching disk try DSR.

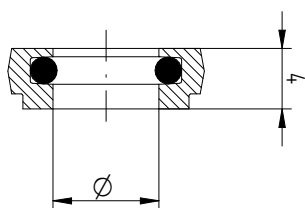

DS / ER

Type	Part no.	Ø [inch]	Bore Ø		Incl. in set
			[mm]	[inch]	
DS / ER 32					
DS / ER 32 SET (34 Stk./ pcs.)	3932.00000	–	3.0–20.0	0.1181–0.7874	–
Ø 3.0 mm	3932.00300	3/32"	3.0–2.5	0.1181–0.0984	–
Ø 3.5 mm	3932.00350	1/8"	3.5–3.0	0.1378–0.1181	•
Ø 4.0 mm	3932.00400	5/32"	4.0–3.5	0.1575–0.1378	•
Ø 4.5 mm	3932.00450	–	4.5–4.0	0.1772–0.1575	•
Ø 5.0 mm	3932.00500	3/16"	5.0–4.5	0.1969–0.1772	•
Ø 5.5 mm	3932.00550	7/32"	5.5–5.0	0.2165–0.1969	•
Ø 6.0 mm	3932.00600	–	6.0–5.5	0.2362–0.2165	•
Ø 6.5 mm	3932.00650	1/4"	6.5–6.0	0.2559–0.2362	•
Ø 7.0 mm	3932.00700	–	7.0–6.5	0.2756–0.2559	•
Ø 7.5 mm	3932.00750	9/32"	7.5–7.0	0.2953–0.2756	•
Ø 8.0 mm	3932.00800	5/16"	8.0–7.5	0.315–0.2953	•
Ø 8.5 mm	3932.00850	–	8.5–8.0	0.3346–0.315	•
Ø 9.0 mm	3932.00900	11/32"	9.0–8.5	0.3543–0.3346	•
Ø 9.5 mm	3932.00950	3/8"	9.5–9.0	0.374–0.3543	•
Ø 10.0 mm	3932.01000	–	10.0–9.5	0.3937–0.374	•
Ø 10.5 mm	3932.01050	13/32"	10.5–10.0	0.4134–0.3937	•
Ø 11.0 mm	3932.01100	–	11.0–10.5	0.4331–0.4134	•
Ø 11.5 mm	3932.01150	7/16"	11.5–11.0	0.4528–0.4331	•
Ø 12.0 mm	3932.01200	15/32"	12.0–11.5	0.4724–0.4528	•
Ø 12.5 mm	3932.01250	–	12.5–12.0	0.4921–0.4724	•
Ø 13.0 mm	3932.01300	1/2"	13.0–12.5	0.5118–0.4921	•
Ø 13.5 mm	3932.01350	17/32"	13.5–13.0	0.5315–0.5118	•
Ø 14.0 mm	3932.01400	–	14.0–13.5	0.5512–0.5315	•
Ø 14.5 mm	3932.01450	9/16"	14.5–14.0	0.5709–0.5512	•
Ø 15.0 mm	3932.01500	–	15.0–14.5	0.5905–0.5709	•
Ø 15.5 mm	3932.01550	19/32"	15.5–15.0	0.6102–0.5906	•
Ø 16.0 mm	3932.01600	5/8"	16.0–15.5	0.6299–0.6102	•
Ø 16.5 mm	3932.01650	–	16.5–16.0	0.6496–0.6299	•
Ø 17.0 mm	3932.01700	21/32"	17.0–16.5	0.6693–0.6496	•
Ø 17.5 mm	3932.01750	11/16"	17.5–17.0	0.689–0.6693	•
Ø 18.0 mm	3932.01800	–	18.0–17.5	0.7087–0.689	•
Ø 18.5 mm	3932.01850	23/32"	18.5–18.0	0.7283–0.7087	•
Ø 19.0 mm	3932.01900	3/4"	19.0–18.5	0.748–0.7283	•
Ø 19.5 mm	3932.01950	–	19.5–19.0	0.7677–0.748	•
Ø 20.0 mm	3932.02000	25/32"	20.0–19.5	0.7874–0.7677	•

Included in the DS/ER sets are all marked disks within that ER size and the matching disk try DSR.

Type	Part no.	Ø [inch]	Bore Ø		Incl. in set
			[mm]	[inch]	
DS / ER 40					
DS / ER 40 SET (46 Stk. / pcs.)	3940.00000	–	3.0–26.0	0.1181–1.0236	–
Ø 3.0 mm	3940.00300	3/32"	3.0–2.5	0.1181–0.0984	–
Ø 3.5 mm	3940.00350	1/8"	3.5–3.0	0.1378–0.1181	•
Ø 4.0 mm	3940.00400	5/32"	4.0–3.5	0.1575–0.1378	•
Ø 4.5 mm	3940.00450	–	4.5–4.0	0.1772–0.1575	•
Ø 5.0 mm	3940.00500	3/16"	5.0–4.5	0.1969–0.1772	•
Ø 5.5 mm	3940.00550	7/32"	5.5–5.0	0.2165–0.1969	•
Ø 6.0 mm	3940.00600	–	6.0–5.5	0.2362–0.2165	•
Ø 6.5 mm	3940.00650	1/4"	6.5–6.0	0.2559–0.2362	•
Ø 7.0 mm	3940.00700	–	7.0–6.5	0.2756–0.2559	•
Ø 7.5 mm	3940.00750	9/32"	7.5–7.0	0.2953–0.2756	•
Ø 8.0 mm	3940.00800	5/16"	8.0–7.5	0.315–0.2953	•
Ø 8.5 mm	3940.00850	–	8.5–8.0	0.3347–0.315	•
Ø 9.0 mm	3940.00900	11/32"	9.0–8.5	0.3543–0.3347	•
Ø 9.5 mm	3940.00950	3/8"	9.5–9.0	0.374–0.3543	•
Ø 10.0 mm	3940.01000	–	10.0–9.5	0.3937–0.374	•
Ø 10.5 mm	3940.01050	13/32"	10.5–10.0	0.4134–0.3937	•
Ø 11.0 mm	3940.01100	–	11.0–10.5	0.433–0.4134	•
Ø 11.5 mm	3940.01150	7/16"	11.5–11.0	0.4528–0.433	•
Ø 12.0 mm	3940.01200	15/32"	12.0–11.5	0.4724–0.4528	•
Ø 12.5 mm	3940.01250	–	12.5–12.0	0.4921–0.4724	•
Ø 13.0 mm	3940.01300	1/2"	13.0–12.5	0.5118–0.4921	•
Ø 13.5 mm	3940.01350	17/32"	13.5–13.0	0.5315–0.5118	•
Ø 14.0 mm	3940.01400	–	14.0–13.5	0.5512–0.5315	•
Ø 14.5 mm	3940.01450	9/16"	14.5–14.0	0.5709–0.5512	•
Ø 15.0 mm	3940.01500	–	15.0–14.5	0.5905–0.5709	•
Ø 15.5 mm	3940.01550	19/32"	15.5–15.0	0.6102–0.5905	•
Ø 16.0 mm	3940.01600	5/8"	16.0–15.5	0.6299–0.6102	•

Included in the DS/ER sets are all marked disks within that ER size and the matching disk try DSR.

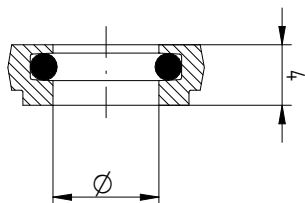

DS / ER

Type	Part no.	Ø [inch]	Bore Ø		Incl. in set
			[mm]	[inch]	
DS / ER 40 continued					
Ø 16.5 mm	3940.01650	–	16.5–16.0	0.6496–0.6299	•
Ø 17.0 mm	3940.01700	21/32"	17.0–16.5	0.6693–0.6496	•
Ø 17.5 mm	3940.01750	11/16"	17.5–17.0	0.689–0.6693	•
Ø 18.0 mm	3940.01800	–	18.0–17.5	0.7087–0.689	•
Ø 18.5 mm	3940.01850	23/32"	18.5–18.0	0.7283–0.7087	•
Ø 19.0 mm	3940.01900	3/4"	19.0–18.5	0.748–0.7283	•
Ø 19.5 mm	3940.01950	–	19.5–19.0	0.7677–0.748	•
Ø 20.0 mm	3940.02000	23/32"	20.0–19.5	0.7874–0.7677	•
Ø 20.5 mm	3940.02050	–	20.5–20.0	0.8071–0.7874	•
Ø 21.0 mm	3940.02100	13/16"	21.0–20.5	0.8268–0.8071	•
Ø 21.5 mm	3940.02150	25/32"	21.5–21.0	0.8465–0.8268	•
Ø 22.0 mm	3940.02200	–	22.0–21.5	0.8661–0.8465	•
Ø 22.5 mm	3940.02250	7/8"	22.5–22.0	0.8858–0.8661	•
Ø 23.0 mm	3940.02300	29/32"	23.0–22.5	0.9055–0.8858	•
Ø 23.5 mm	3940.02350	–	23.5–23.0	0.9252–0.9055	•
Ø 24.0 mm	3940.02400	15/16"	24.0–23.5	0.9449–0.9252	•
Ø 24.5 mm	3940.02450	–	24.5–24.0	0.9646–0.9449	•
Ø 25.0 mm	3940.02500	31/32"	25.0–24.5	0.9843–0.9646	•
Ø 25.5 mm	3940.02550	1"	25.5–25.0	1.0039–0.9843	•
Ø 26.0 mm	3940.02600	–	26.0–25.5	1.0236–1.0039	•

DS / ER 50					
ADP ER 50–DS / ER 40*	3950.40000	–	3.0–26.0	0.1181–1.0236	–
Ø 22.0 mm	3950.02200	–	22.0–21.5	0.8661–0.8465	–
Ø 25.0 mm	3950.02500	–	25.0–24.5	0.9842–0.9645	–
Ø 28.0 mm	3950.02800	–	28.0–27.5	1.1023–1.0827	–
Ø 32.0 mm	3950.03200	–	32.0–31.5	1.2598–1.2402	–
Ø 36.0 mm	3950.03600	–	36.0–35.5	1.4173–1.3976	–

* The ADP ER 50-DS/ER 40 only works in combination with a sealing disk DS/ER 40. DS/ER 40 is not included in delivery.

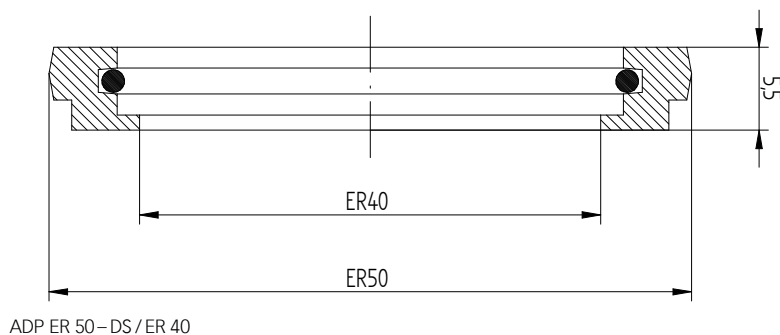

Expert advice

The adapter ADP ER 50–DS / ER 40 allows the use of DS / ER 40 sealing disks in ER 50 clamping nuts.



Our solution for peripheral cooling

The design of our coolant flush disks leads the coolant along the edge of the cutting tool, providing you with an easy way to achieve peripheral cooling.

Key advantages

Swiss quality disks

Marking

Type and size (reduced disk selection errors).

Traceability

Lot number marking on all products for traceability through the entire manufacturing process.

Original REGO-FIX

Our long-lasting machining experience results in a well-engineered system. When buying ER coolant flush disks please pay attention to the REGO-FIX quality seal on the coolant flush disk: The triangle is our seal for outstanding quality made in Switzerland.

Universal use

For all REGO-FIX collets and coolant nuts with interchangeable disk.

Interchangeable

Quick change of coolant flush disks according to required tool shank diameter.

Peripheral cooling

For better cooling and lubrication.
Extends tool life and supports chip removal.

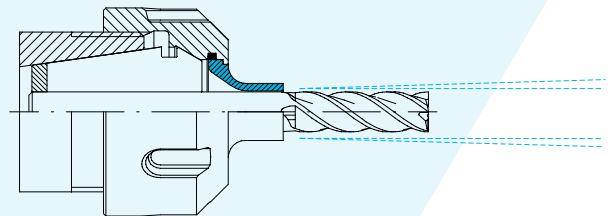

KS/ER

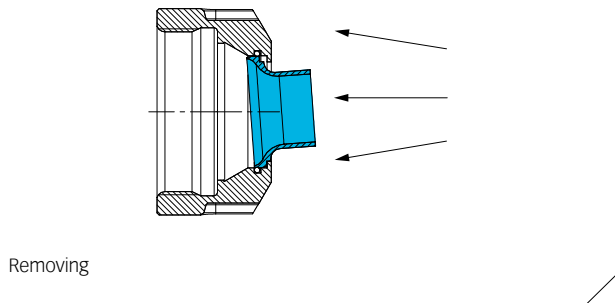
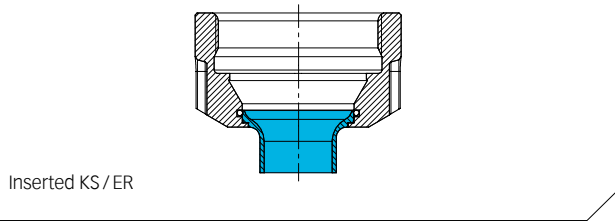
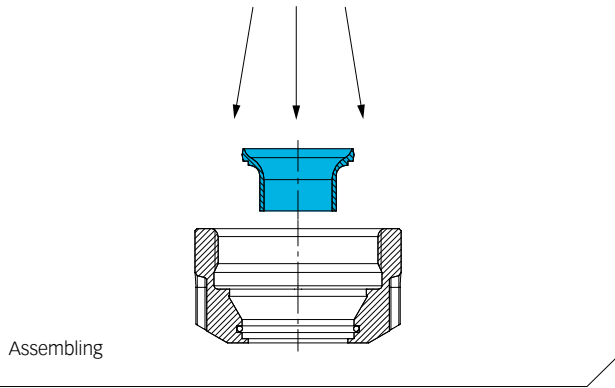

Assembling Insert the small diameter of the disk into the center of the coolant nut. Apply an even pressure until the disk is properly seated into the nut.

The disk must be flush with the outside of the nut and the marking on the disk must be seen inside the nut.

Removing To remove the disk, simply press on the outside of the disk evenly until it snaps out.

Type	Part no.	Dimensions [mm]			Ø	
		D	L	[mm]	[inch]	
KS / ER 16 [mm]						
Ø 3.0 mm	3916.20300	6.4	11	3	–	–
Ø 4.0 mm	3916.20400	7.4	11	4	–	–
Ø 5.0 mm	3916.20500	8.4	11	5	–	–
Ø 6.0 mm	3916.20600	9.4	11	6	–	–
Ø 7.0 mm	3916.20700	11	11	7	–	–
Ø 8.0 mm	3916.20800	11	11	8	–	–
Ø 9.0 mm	3916.20900	11	2	9	–	–
Ø 10.0 mm	3916.21000	11	2	10	–	–
BLANK KS / ER 16, Ø 11 x 12*	3916.29999	11	12	–	–	–

KS / ER 16 [inch]						
Ø 1/8"	3916.30318	6.6	11	3.175	1/8"	–
Ø 3/16"	3916.30476	8.2	11	4.763	3/16"	–
Ø 1/4"	3916.30635	9.7	11	6.35	1/4"	–
Ø 5/16"	3916.30794	11	11	7.938	5/16"	–
Ø 3/8"	3916.30953	11	2	9.525	3/8"	–

KS / ER 20 [mm]						
Ø 3.0 mm	3920.20300	6.4	11	3	–	–
Ø 4.0 mm	3920.20400	7.4	11	4	–	–
Ø 5.0 mm	3920.20500	8.4	11	5	–	–
Ø 6.0 mm	3920.20600	9.4	11	6	–	–
Ø 7.0 mm	3920.20700	10.4	11	7	–	–
Ø 8.0 mm	3920.20800	11.4	11	8	–	–
Ø 9.0 mm	3920.20900	12.4	11	9	–	–
Ø 10.0 mm	3920.21000	14	11	10	–	–
Ø 12.0 mm	3920.21200	14	3	12	–	–
BLANK KS / ER 20, Ø 14 x 12*	3920.29999	14	12	–	–	–

* Work material: 42CrMoS4 (1.7227).

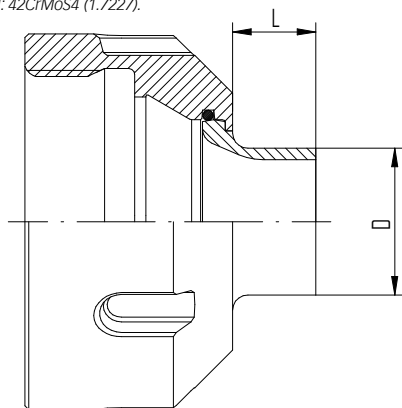

KS / ER

Type	Part no.	Dimensions [mm]		Ø	
		D	L	[mm]	[inch]
KS / ER 20 [inch]					
Ø 1/8"	3920.30318	6.6	11	3.175	1/8"
Ø 3/16"	3920.30476	8.2	11	4.763	3/16"
Ø 1/4"	3920.30635	9.7	11	6.35	1/4"
Ø 5/16"	3920.30794	11.3	11	7.983	5/16"
Ø 3/8"	3920.30953	14	11	9.525	3/8"
Ø 7/16"	3920.31111	14	11	11.113	7/16"
Ø 1/2"	3920.31270	14	3	12.7	1/2"

KS / ER 25 [mm]					
Ø 3.0 mm	3925.20300	6.4	11	3	–
Ø 4.0 mm	3925.20400	7.4	11	4	–
Ø 5.0 mm	3925.20500	8.4	11	5	–
Ø 6.0 mm	3925.20600	9.4	11	6	–
Ø 7.0 mm	3925.20700	10.4	11	7	–
Ø 8.0 mm	3925.20800	11.4	11	8	–
Ø 9.0 mm	3925.20900	12.4	11	9	–
Ø 10.0 mm	3925.21000	13.4	11	10	–
Ø 12.0 mm	3925.21200	15.4	11	12	–
Ø 14.0 mm	3925.21400	17.4	11	14	–
Ø 16.0 mm	3925.21600	19	11	16	–
BLANK KS / ER 25, Ø 19 x 12*	3925.29999	19	12	–	–

KS / ER 25 [inch]					
Ø 1/8"	3925.30318	6.6	11	3.175	1/8"
Ø 3/16"	3925.30476	8.2	11	4.763	3/16"
Ø 1/4"	3925.30635	9.7	11	6.35	1/4"
Ø 5/16"	3925.30794	11.3	11	7.938	5/16"
Ø 3/8"	3925.30953	12.9	11	9.525	3/8"
Ø 7/16"	3925.31111	14.5	11	11.113	7/16"
Ø 1/2"	3925.31270	16.1	11	12.7	1/2"
Ø 9/16"	3925.31429	17.7	11	14.288	9/16"
Ø 5/8"	3925.31588	19	11	15.875	5/8"

* Work material: 42CrMoS4 (1.7227).

Type	Part no.	Dimensions [mm]			Ø	
		D	L	[mm]	[inch]	
KS / ER 32 [mm]						
Ø 3.0 mm	3932.20300	6.4	11	3	–	–
Ø 4.0 mm	3932.20400	7.4	11	4	–	–
Ø 5.0 mm	3932.20500	8.4	11	5	–	–
Ø 6.0 mm	3932.20600	9.4	11	6	–	–
Ø 7.0 mm	3932.20700	10.4	11	7	–	–
Ø 8.0 mm	3932.20800	11.4	11	8	–	–
Ø 9.0 mm	3932.20900	12.4	11	9	–	–
Ø 10.0 mm	3932.21000	13.4	11	10	–	–
Ø 12.0 mm	3932.21200	15.4	11	12	–	–
Ø 14.0 mm	3932.21400	17.4	11	14	–	–
Ø 16.0 mm	3932.21600	19.4	11	16	–	–
Ø 18.0 mm	3932.21800	21.4	11	18	–	–
Ø 20.0 mm	3932.22000	24	11	20	–	–
BLANK KS / ER 32, Ø 24 x 12*	3932.29999	24	12	–	–	–

KS / ER 32 [inch]						
Ø 1/8"	3932.30318	6.6	11	3.175	1/8"	–
Ø 3/16"	3932.30476	8.2	11	4.763	3/16"	–
Ø 1/4"	3932.30635	9.7	11	6.35	1/4"	–
Ø 5/16"	3932.30794	11.3	11	7.938	5/16"	–
Ø 3/8"	3932.30953	12.9	11	9.525	3/8"	–
Ø 7/16"	3932.31111	14.5	11	11.113	7/16"	–
Ø 1/2"	3932.31270	16.1	11	12.7	1/2"	–
Ø 9/16"	3932.31429	17.7	11	14.288	9/16"	–
Ø 5/8"	3932.31588	19.3	11	15.875	5/8"	–
Ø 3/4"	3932.31905	24	11	19.05	3/4"	–

* Work material: 42CrMoS4 (1.7227).

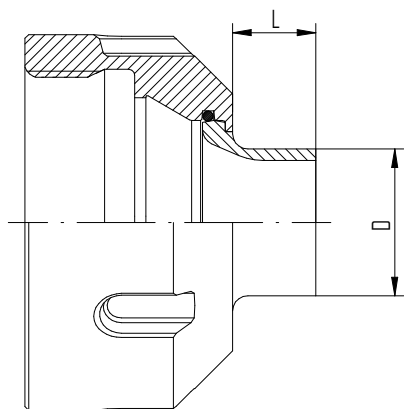

KS / ER



REGO-FIX▲



Contents

ER accessories

Enhance your tool life with the proper accessories for safe toolholding.

Wrenches	150
Torque wrenches TORCO-FIX	152
Slip-off proof extension V-E AX for E AX and A-E AX	152
Slip-off proof extension V-E MX for E MX and A-E MX	152
Wrench heads	153
Trays for ER collet sets ZWT	154
Trays for sealing disk sets DSR	154
Tangs	154
Coolant tubes KSR	155
Wrenches for coolant tubes SKR	155
Toolholding fixtures	156
Hi-Q® balancing rings FWR	157
Torque screwdriver TSD	157



Wrenches

E	EP
EM	EMX

Type	Part no.	A [mm]	B [mm]	Nut Type							
				ER	ERC	ERB	ERBC	ERM	ERMC	ERMX	ERMXC
E											
E 16	7111.16000	55	163	-	-	-	-	-	-	-	-
E 20	7111.20000	60	183	-	-	-	-	-	-	-	-
E 25	7111.25000	70	203	•	•	•	•	-	-	-	-
E 32	7111.32000	80	253	•	•	•	•	-	-	-	-
E 40	7111.40000	96	283	•	•	•	•	-	-	-	-
E 50	7111.50000	111	350	•	-	•	-	-	-	-	-
EP											
E 11 P	7112.11010	32	95	•	•	-	-	-	-	-	-
E 16 P	7112.16010	44	145	•	•	•	•	-	-	-	-
E 20 P	7112.20010	52	170	•	•	•	•	-	-	-	-
EM											
E 8 M	7113.08000	12	74	-	-	-	-	•	-	-	-
E 11 M	7113.11000	17	95	-	-	-	-	•	•	-	-
E 16 M	7113.16000	22	117	-	-	-	-	•	•	-	-
E 20 M	7113.20000	29	129	-	-	-	-	•	•	-	-
E 25 M	7113.25000	36	141	-	-	-	-	•	•	-	-
EMX											
E 8 MX	7118.08000	12	74	-	-	-	-	-	-	•	-
E 11 MX	7118.11000	17	95	-	-	-	-	-	-	•	•
E 16 MX	7118.16000	22.5	117	-	-	-	-	-	-	•	•
E 20 MX	7118.20000	29	129	-	-	-	-	-	-	•	•
E 25 MX	7118.25000	36	141	-	-	-	-	-	-	•	•

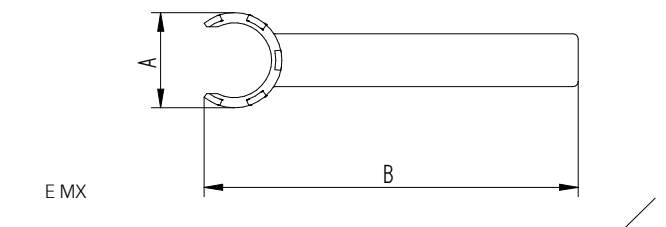
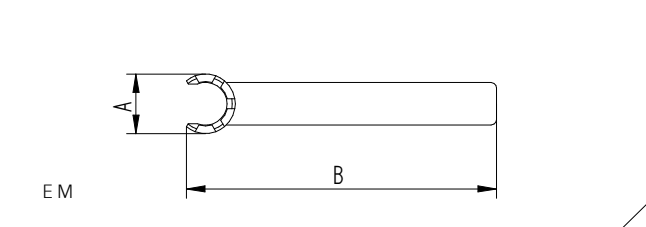
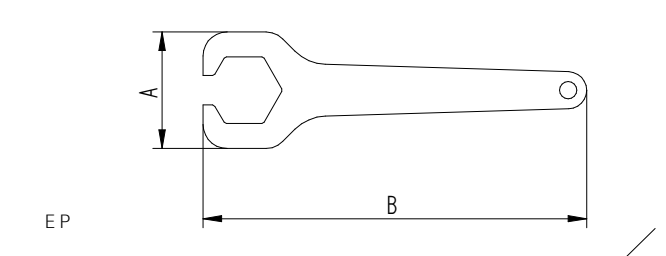
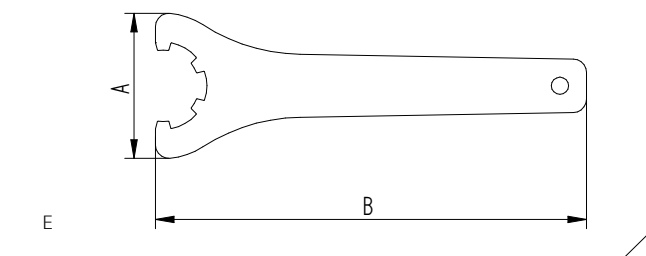

Type	Part no.	A [mm]	B [mm]	Nut Type		
				ER MS	ERAX	ERAXC
E MS						
E 8 MS	7114.08000	19	76	•	–	–
E 11 MS	7114.11000	22	100	•	–	–
E 16 MS	7114.16000	33	130	•	–	–
E 20 MS	7114.20000	42	140	•	–	–
E A						
E 11 A	7115.11000	18.6	96	–	–	–
E 16 A	7115.16000	25	108	–	–	–
E 20 A	7115.20000	28	123	–	–	–
E 25 A	7115.25000	30.5	139	–	–	–
E 32 A	7115.32000	42	182	–	–	–
E AX						
E 11 AX	7117.11000	16	108	–	•	–
E 16 AX	7117.16000	22	131	–	•	•
E 20 AX	7117.20000	26	148	–	•	•
E 25 AX	7117.25000	30	165	–	•	•
E 32 AX	7117.32000	37	196	–	•	•
E 40 AX	7117.40000	47	220	–	•	•

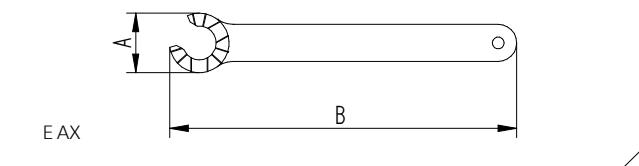
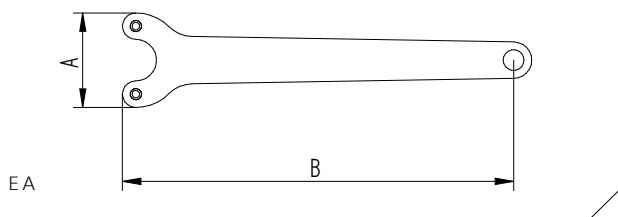
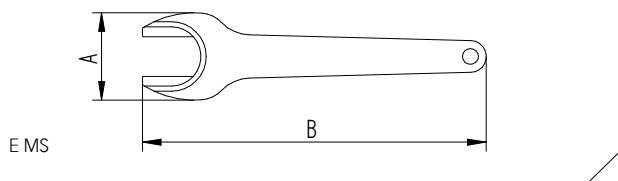

Torque wrenches

Torque wrench

V-E AX

V-E MX

Slip-off proof extension V-E AX for E AX and A-E AX

Slip-off proof extension V-E MX for E MX and A-E MX

Type	Part no.	L1 [mm]	Range [ft-lbs]
Torque wrenches			
Micro	7150.02025	335	2.0–25.0
Small	8020.10050	300	7.5–37.0
Medium	8020.20100	340	15.0–80.0
Large	8020.60300	545	45.0–220.0

Type	Part no.	D [mm]	L [mm]	Square <input type="checkbox"/>	
				[mm]	[inch]
V-E AX					
V-E 11 AX	7155.11000	16.5	60	6.35	1/4"
V-E 16 AX	7155.16000	22.5	80	6.35	1/4"
V-E 20 AX	7155.20000	26	95	9.525	3/8"
V-E 25 AX	7155.25000	29.5	105	12.7	1/2"
V-E 32 AX	7155.32000	37.5	115	12.7	1/2"

Type	Part no.	D [mm]	L [mm]	Square <input type="checkbox"/>	
				[mm]	[inch]
V-E MX					
V-E 8 MX	7159.08000	17	60	6.35	1/4"
V-E 11 MX	7159.11000	17	60	6.35	1/4"
V-E 16 MX	7159.16000	22.5	80	6.35	1/4"
V-E 20 MX	7159.20000	29	95	12.7	1/2"
V-E 25 MX	7159.25000	35	105	19.05	3/4"

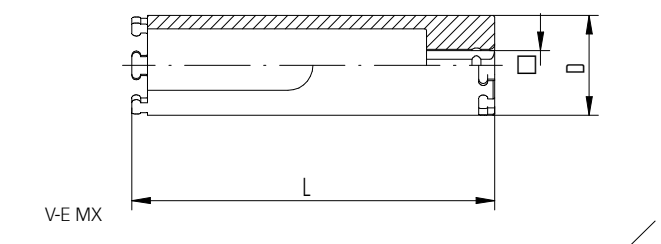
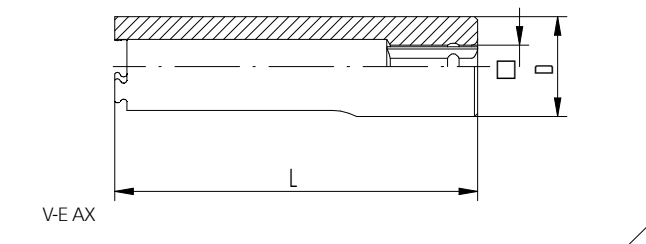
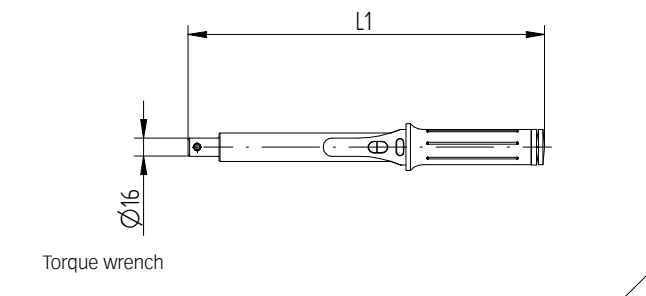

Wrench heads

A-E

A-E P

A-E M

A-E MS

A-E AX

Type	Part no.	A [mm]	B [mm]
A-E			
A-E 16	7151.16000	55	62
A-E 20	7151.20000	60	62
A-E 25	7151.25000	70	72
A-E 32	7151.32000	80	72
A-E 40	7151.40000	96	82
A-E 50	7151.50000	111	94

A-E P			
A-E 11 P	7152.11010	32	57
A-E 16 P	7152.16010	44	70
A-E 20 P	7152.20010	52	80

A-E M			
A-E 8 M	7153.08000	12	53
A-E 11 M	7153.11000	17	54
A-E 16 M	7153.16000	22	56
A-E 20 M	7153.20000	29	68
A-E 25 M	7153.25000	36	70

A-E MX			
A-E 8 MX	7158.08000	12	53
A-E 11 MX	7158.11000	17	54
A-E 16 MX	7158.16000	22	56
A-E 20 MX	7158.20000	29	68
A-E 25 MX	7158.25000	36	70

A-E MS			
A-E 8 MS	7154.08000	19	51
A-E 11 MS	7154.11000	22	57
A-E 16 MS	7154.16000	33	60
A-E 20 MS	7154.20000	42	73

A-E AX			
A-E 11 AX	7157.11000	16	62
A-E 16 AX	7157.16000	22	63
A-E 20 AX	7157.20000	26	64
A-E 25 AX	7157.25000	29	93
A-E 32 AX	7157.32000	37	95
A-E 40 AX	7157.40000	47	99

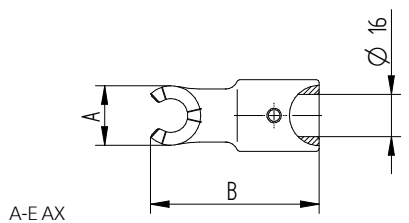
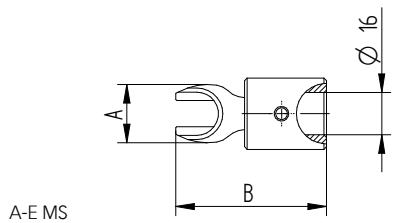
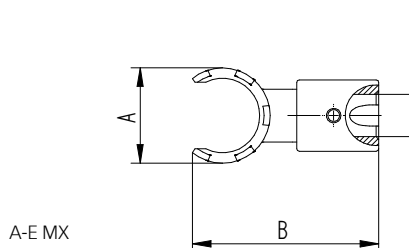
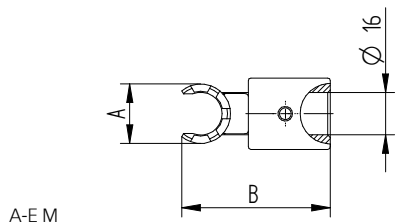
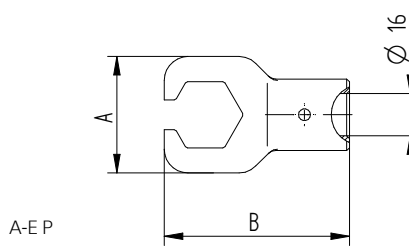
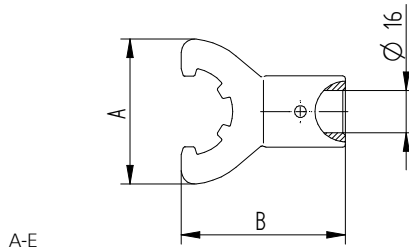

Trays for ER collet sets ZWT

Trays for sealing disk sets DSR

Tangs

Type	Part no.	Fits ... items
Trays for ER Inch collet sets ZWT		
ZWT 8 inch	7121.08300	3
ZWT 11 inch	7121.11300	7
ZWT 16 inch	7121.16300	12
ZWT 20 inch	7121.20300	7
ZWT 25 inch	7121.25300	9
ZWT 32 inch	7121.32300	12
ZWT 40 inch	7121.40300	14

Trays for ER Metric collet sets ZWT		
ZWT 8	0712.10800	9
ZWT 11	0712.11100	13
ZWT 16	0712.11600	10
ZWT 20	0712.12000	12
ZWT 25	0712.12500	15
ZWT 32	0712.13200	18
ZWT 40	0712.14000	23
ZWT 50	0712.15000	12

Trays for sealing disk sets DSR		
DSR 16	0712.21600	14
DSR 20	0712.22000	20
DSR 25	0712.22500	26
DSR 32	0712.23200	34
DSR 40	0712.24000	46

Type	Part no.	G	Dimensions [mm]	
			D	L
Tangs ATL				
ATL 6 / MK 1	7221.01000	M 6	8.5	21.5
ATL 10 / MK 2	7221.02000	M 10	13.5	30.5
ATL 12 / MK 3	7221.03000	M 12	18.5	35
ATL 16 / MK 4	7221.04000	M 16	24.5	41
ATL 20 / MK 5	7221.05000	M 20	35	52

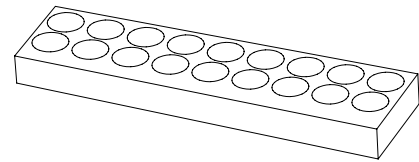

ZWT

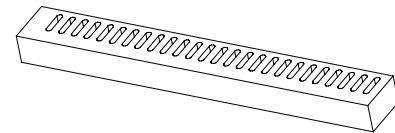

DSR

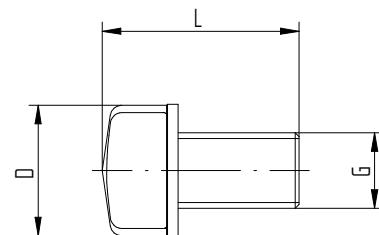

ATL / MK

Wrenches for coolant tubes SKR

Type	Part no.	Dimensions [mm]			G
		D	L	L1	
Coolant tubes KSR					
KSR 25	7211.25000	5	4.5	17	M 8 x 1
KSR 32	7211.32000	6	5.5	25.7	M 10 x 1
KSR 40	7211.40000	8	7.5	29.2	M 12 x 1
KSR 50	7211.50000	10	9.5	32.7	M 16 x 1
KSR 63	7211.63000	12	11.5	36.2	M 18 x 1
KSR 80	7211.80000	14	13.5	39.7	M 20 x 1.5
KSR 100	7211.00000	16	15.5	43.6	M 24 x 1.5
KSR 125	7211.12500	16	15.5	43.6	M 24 x 1.5

Type	Part no.
Wrenches SKR	
SKR 25	7212.25000
SKR 32	7212.32000
SKR 40	7212.40000
SKR 50	7212.50000
SKR 63	7212.63000
SKR 80	7212.80000
SKR 100	7212.00000
SKR 125	7212.12500

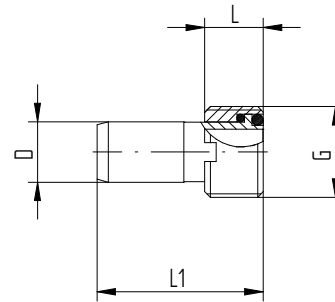

KSR

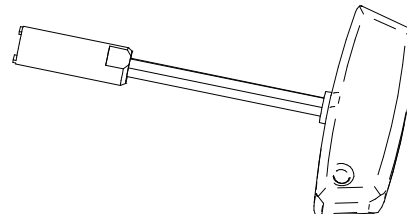

SKR

Expert advice

For all HSK form A and HSK form E collets all listed coolant tubes (KSR) can be used.

Toolholding fixtures

WMH	WA / SK
WA / HSK	WA / C

Type	Part no.	Fits this interface
Tool assembly WMH		
WMH-AC 45°	7813.00000	–
WMH-AC 90°	7813.00100	–

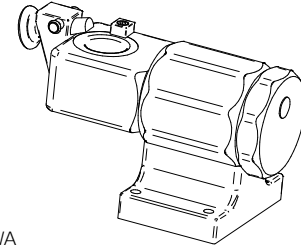

WMH / WA

Tool adapter WA / SK		
WA / SK 30	7814.30100	BT / CAT / SK 30
WA / SK 40	7814.40100	BT / CAT / SK 40
WA / SK 50	7814.50100	BT / CAT / SK 50

Tool adapter WA / HSK-A / C / E		
WA / HSK-A / C / E 25	7814.25300	HSK-A / C / E 25

Tool adapter WA / HSK-A		
WA / HSK-A 32	7814.32200	HSK-A 32
WA / HSK-A 40	7814.40200	HSK-A 40
WA / HSK-A 50	7814.50200	HSK-A 50
WA / HSK-A 63	7814.63200	HSK-A 63
WA / HSK-A 80	7814.80200	HSK-A 80
WA / HSK-A 100	7814.00200	HSK-A 100

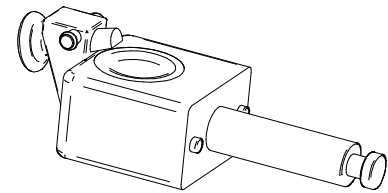

WA

Tool adapter WA / HSK-C / E		
WA / HSK-C / E 32	7814.32500	HSK-C / E 32
WA / HSK-C / E 40	7814.40500	HSK-C / E 40
WA / HSK-C / E 50	7814.50500	HSK-C / E 50
WA / HSK-C / E 63	7814.63500	HSK-C / E 63

Tool adapter WA / HSK-B / D / F		
WA / HSK-B / D / F 63	7814.63400	HSK-B / D / F 63

Tool adapter WA / C		
WA / C3	7814.03700	CAPTO C3
WA / C4	7814.04700	CAPTO C4
WA / C5	7814.05700	CAPTO C5
WA / C6	7814.06700	CAPTO C6
WA / C8	7814.08700	CAPTO C8

Hi-Q® balancing rings FWR

FWR

TSD

Torque screwdriver TSD

Type	Part no.	Dimensions [mm]			Balancing capacity [gmm]		
		D	d	L	FWR SET	single FWR	max. rpm
Hi-Q® balancing rings FWR							
SET FWR 225	7490.22500	30.5	22.5	6	16	8	80.000
SET FWR 285	7490.28500	36.5	28.5	6	32	16	70.000
SET FWR 325	7490.32500	40.5	32.5	6	44	22	60.000
SET FWR 405	7490.40500	48.5	40.5	6	52	26	50.000
SET FWR 505	7490.50500	60.5	50.5	7	130	65	42.000

Included in set: Two Hi-Q® balancing rings per set.



Balancing rings SET FWR

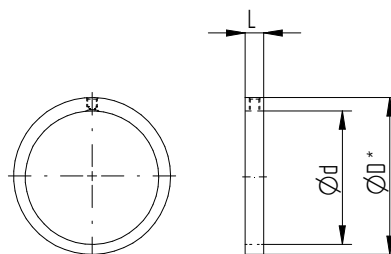

Single balancing ring

* Rotational diameter

Type	Part no.
TSD TORX 8 for balancing rings	
TSD 0.9 Nm	7159.09000

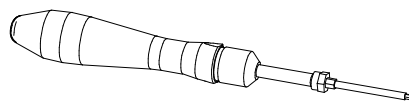

TSD

Expert advice

The torque screwdriver is a special TORX style wrench that is preset to the recommended torque rating of 0.9 Nm for tightening the REGO-FIX Hi-Q® balancing rings.



Contents

Technical information

Dimensions for ER collet cavities in machine spindles and matching clamping nuts	160
ER collet dimensions	161
Mounting instructions ER System	162
Clamping nut recommended tightening torque (ft-lbs)	163
Clamping nut recommended tightening torque (Nm)	164
Shank diameter of taps	165
Technical information for tapping collets ER-GB	166
Technical information for tapping collets PCM ET1	167
Technical information for microbore collets	167



Dimensions for ER collet cavities in machine spindles and matching clamping nuts

ER size	Diameter range [mm]	Hi-Q®										Measurements [mm]				
		ER	ERC	ERB	ERBC	ERM	ERMC	ERMX	ERMXC	AX	AXC	A	B	C	E	F
11	0.5–7.0	•	•	–	–	–	–	–	–	–	–	7.5	11	M 14 x 0.75	17	10
16	0.5–10.0	•	•	•	•	–	–	–	–	–	–	10.5	16	M 22 x 1.5	22	13
20	0.5–13.0	•	•	•	•	–	–	–	–	–	–	13.5	20	M 24 x 1.5	26.5	13.5
25	0.5–17.0	•	•	•	•	–	–	–	–	–	–	18.0	25	M 32 x 1.5	29	14
32	1.0–22.0	•	•	•	•	–	–	–	–	–	–	23.5	32	M 40 x 1.5	34	16
40	2.0–30.0	•	•	•	•	–	–	–	–	–	–	30.5	40	M 50 x 1.5	38	17
50	4.0–36.0	•	•	•	•	–	–	–	–	–	–	38	50	M 64 x 2	48	24
<hr/>																
8	0.5–5.0	–	–	–	–	•	–	•	–	–	–	5.2	8	M 10 x 0.75	13	8
11	0.5–7.0	–	–	–	–	•	•	•	•	–	–	7.5	11	M 13 x 0.75	17	8.5
16	0.5–10.0	–	–	–	–	•	•	•	•	–	–	10.5	16	M 19 x 1	22	13
20	0.5–13.0	–	–	–	–	•	•	•	•	–	–	13.5	20	M 28 x 1.5	26.5	13.5
25	0.5–17.0	–	–	–	–	•	•	•	•	–	–	18	25	M 30 x 1	29	14
<hr/>																
11	0.5–7.0	–	–	–	–	–	–	–	–	•	–	7.5	11	M 18 x 1	23	7
16	0.5–10.0	–	–	–	–	–	–	–	–	•	•	10.5	16	M 24 x 1	32	10
20	0.5–13.0	–	–	–	–	–	–	–	–	•	•	13.5	20	M 28 x 1.5	37.5	11
25	0.5–17.0	–	–	–	–	–	–	–	–	•	•	18	25	M 32 x 1.5	41	12
32	1.0–22.0	–	–	–	–	–	–	–	–	•	•	23.5	32	M 40 x 1.5	48	12
40	2.0–30.0	–	–	–	–	–	–	–	–	•	•	30.5	40	M 50 x 1.5	54	16

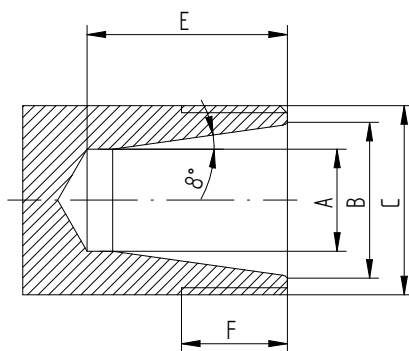

All other standard ER cavities

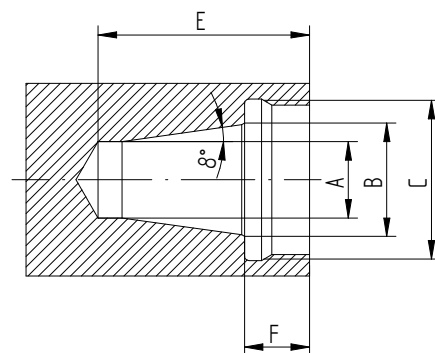

ER AX and ER AXC cavities

ER collets dimensions

Size [mm]		Measurements [mm]									
D2	d	D1	D2	D3	D4	L	L1**	L2	L3	L4	Drawing
ER 8	1.0-2.5	8.5	8	6.5	4	13.6	2.98	1.2	1.5	6.	1
ER 8	3.0-5.0	8.5	8	6.5	-	13.6	2.98	1.2	1.5	-	2
ER 11	1.0-2.5	11.5	11	9.5	5	18	3.8	2	2.5	9	3
ER 11	3.0-7.0	11.5	11	9.5	-	18	3.8	2	2.5	-	4
ER 16	1.0-1.59	17	16	13.8	7.5	27.5	6.26	2.7	4	13	3
ER 16	2.0-4.76	17	16	13.8	7.5	27.5	6.26	2.7	4	10	3
ER 16	5.0-10.0	17	16	13.8	-	27.5	6.26	2.7	4	-	4
ER 16	9.5-10.0	17	16	13.8	-	26*	6.26	2.7	4	-	4
ER 20	1.0-1.59	21	20	17.4	9	31.5	6.36	2.8	4.8	16	3
ER 20	2.0-6.50	21	20	17.4	9	31.5	6.36	2.8	4.8	13	3
ER 20	7.0-13.0	21	20	17.4	-	31.5	6.36	2.8	4.8	-	4
ER 25	1.0-1.59	26	25	22	12	34	6.66	3.1	5	18	3
ER 25	2.0-7.50	26	25	22	12	34	6.66	3.1	5	15	3
ER 25	8.0-17.0	26	25	22	-	34	6.66	3.1	5	-	4
ER 32	2.0-4.76	33	32	29.2	15	40	7.16	3.6	5.5	20	3
ER 32	5.0-7.5	33	32	29.2	15	40	7.16	3.6	5.5	15	3
ER 32	8.0-22.0	33	32	29.2	-	40	7.16	3.6	5.5	-	4
ER 40	3.0-4.76	41	40	36.2	20	46	7.66	4.1	7	24	3
ER 40	5.0-8.5	41	40	36.2	20	46	7.66	4.1	7	18	3
ER 40	9.0-30.0	41	40	36.2	-	46	7.66	4.1	7	-	4
ER 50	6.0-10.0	52	50	46	20	60	12.6	5.5	8.5	32	3
ER 50	12.0-36.0	52	50	46	-	60	12.6	5.5	8.5	-	4

* Up to 27.5 available, depending on production. ** L1 references to the top plane of the collets holder.

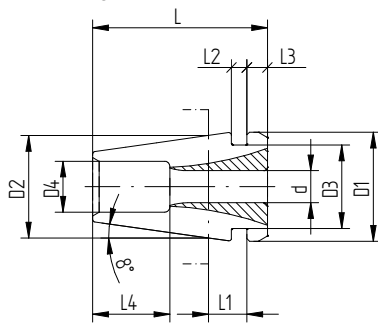

Drawing 1

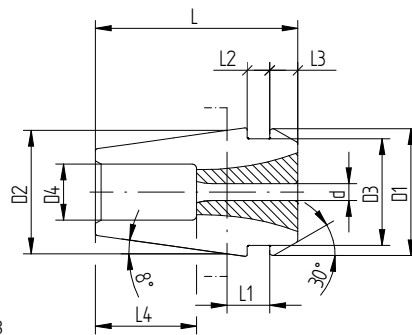

Drawing 3

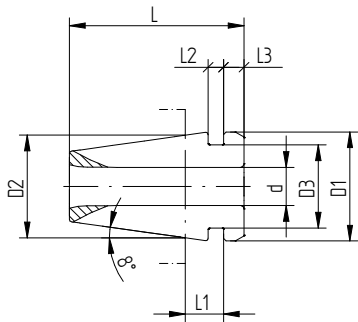

Drawing 2

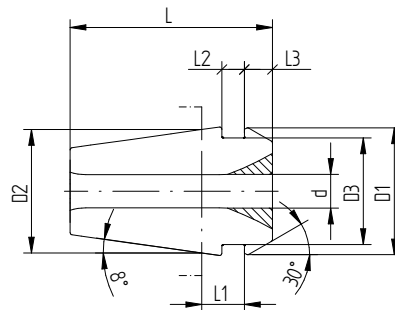

Drawing 4

Increase collet and tool life

Optimize your surface finishes and extend tool life by minimizing occurring vibrations during machining.

Always assemble correctly

First, clip the collet in the nut. Second, insert the tool shank more than $\frac{2}{3}$ into the collet.

1.



2.

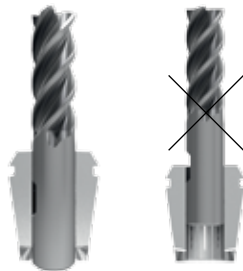

Listen to the click

Do not tighten the torque wrench further after the first click is heard.



Get your TORCO-FIX. Check page 146 for order details.

Only use REGO-FIX wrenches

To mount the collet in the toolholder please use one of these special wrenches. Preferably the torque wrench, as they display the amount of applied force.



Regular wrenches can also be used. Be aware that only the torque wrench will display the exact amount of applied force, making it the most exact tool to mount collets professionally.

Never use any extensions nor hammers



Recommended tightening torque (ft-lbs) for clamping nuts

Collet size	Ø [mm]	Ø [inch]	Hi-Q® clamping nuts											TORCO-FIX
			ER / C		ERB / C		ERM / C		ERMX / C		ERAX / C		ER MS	
													Collets	
			ER*	ER-GB	ER*	ER-GB	ER*	ER-GB	ER*	ER-GB	ER*	ER-GB	ER*	
ER 8 MB	0.2–0.9	0.0078–0.035	–	–	–	–	4	–	4	–	–	–	4	Micro
ER 8	1.0–5.0	0.039–0.196	–	–	–	–	4	–	4	–	–	–	4	Micro
ER 11 MB	0.2–0.9	0.0078–0.035	6	–	–	–	6	–	6	–	6	–	6	Micro, S
ER 11	1.0–2.9	0.039–0.098	6	6	–	–	6	6	6	6	6	6	7	Micro, S
	3.0–7.0	0.118–0.256	24	16	–	–	16	13	16	13	24	21	7	Micro, S
ER 16 MB	0.2–0.9	0.0078–0.035	6	–	–	–	6	–	6	–	6	–	9	Micro, S
ER 16	1.0	0.039	6	–	5	–	6	–	6	–	6	–	9	Micro, S
	1.5–3.5	0.059–0.138	15	–	12	–	15	–	15	–	15	–	15	Micro, S
	4.0–4.5	0.157–0.177	30	30	25	25	18	–	18	–	30	30	15	S, M
	5.0–10.0	0.197–0.394	46	32	40	21	18	–	18	–	30	30	–	M
ER 20	1.0	0.039	12	–	10	–	12	–	12	–	12	–	9	Micro, S
	1.5–6.5	0.059–0.256	25	25	20	20	21	21	21	21	40	25	14	S, M
	7.0–13.0	0.276–0.512	60	60	60	60	21	21	21	21	40	25	14	S, M
ER 25	1.0–3.5	0.059–0.138	18	–	15	–	18	–	18	–	18	–	–	S, M
	4.0–4.5	0.157–0.177	40	40	35	35	24	24	24	24	40	40	–	S, M
	5.0–7.5	0.196–0.295	60	60	55	55	24	24	24	24	60	60	–	M, L
	8.0–17.0	0.315–0.669	80	60	80	60	24	24	24	24	60	60	–	M, L
ER 32	2.0–2.5	0.078–0.098	18	18	15	–	–	–	–	–	20	–	–	S, M
	3.0–7.5	0.118–0.291	100	100	95	65	–	–	–	–	80	65	–	M, L
	8.0–22.0	0.315–0.787	100	100	100	65	–	–	–	–	80	65	–	M, L
ER 40	3.0–26.0	0.118–1.023	130	130	130	130	–	–	–	–	95	95	–	M, L
ER 50	6.0–36.0	0.236–1.417	180	220	180	220	–	–	–	–	–	–	–	L

* Includes ER standard and ER-UP.

Expert advice

The maximum torque must not be more than 25% above the recommended tightening torque. Higher tightening torque may result in damage of the toolholder.

Expert advice

Higher clamping force of the clamping nut means higher stress on the toolholder. We recommend the use of REGO-FIX torque wrench. REGO-FIX will not be responsible for damage to toolholders or spindles of other manufacturers.

Recommended tightening torque (Nm) for ER clamping nuts

		Hi-Q®/ER clamping nuts												
		ER/ERC		ERB/ERBC		ERM/ERMC		ERMx/ERMxC		ERAx/ERAxC		ER MS		
												Collets		
Collet size	Ø [mm]	Ø [inch]	ER*	ER-GB	ER*	ER-GB	ER*	ER-GB	ER*	ER-GB	ER*	ER-GB	ER*	TORCO-FIX
ER 8 MB	0.2–0.9	0.0078–0.035	–	–	–	–	6	–	6	–	–	–	6	Micro
ER 8	1.0–5.0	0.039–0.196	–	–	–	–	6	–	6	–	–	–	6	Micro
ER 11 MB	0.2–0.9	0.0078–0.035	8	–	–	–	8	–	8	–	8	–	8	Micro, S
ER 11	1.0–2.9	0.039–0.098	8	8	–	–	8	8	8	8	8	8	10	Micro, S
	3.0–7.0	0.118–0.256	24	16	–	–	16	13	16	13	24	21	10	Micro, S
ER 16 MB	0.2–0.9	0.0078–0.035	8	–	–	–	8	–	8	–	8	–	12	Micro, S
ER 16	1.0	0.039	8	–	6.4	–	8	–	8	–	8	–	12	Micro, S
	1.5–3.5	0.059–0.138	20	–	16	–	20	–	20	–	20	–	20	Micro, S
	4.0–4.5	0.157–0.177	40	40	32	32	24	–	24	–	40	40	20	S, M
	5.0–10.0	0.197–0.394	56	44	56	44	24	–	24	–	40	40	–	M
ER 20	1.0	0.039	16	–	12	–	16	–	16	–	16	–	12	Micro, S
	1.5–6.5	0.059–0.256	32	32	24	24	28	28	28	28	52	35	18.4	S, M
	7.0–13.0	0.276–0.512	80	35	80	24	28	28	28	28	52	35	18.4	S, M
ER 25	1.0–3.5	0.059–0.138	24	–	20	–	24	–	24	–	24	–	–	S, M
	4.0–4.5	0.157–0.177	56	56	48	48	32	32	32	32	56	56	–	S, M
	5.0–7.5	0.196–0.295	80	80	72	72	32	32	32	32	80	80	–	M, L
	8.0–17.0	0.315–0.669	104	80	104	79	32	32	32	32	80	80	–	M, L
ER 32	2.0–2.5	0.078–0.098	24	24	20	–	–	–	–	–	24	–	–	S, M
	3.0–7.5	0.118–0.291	136	136	128	90	–	–	–	–	104	90	–	M, L
	8.0–22.0	0.315–0.787	136	136	136	90	–	–	–	–	104	90	–	M, L
ER 40	3.0–26.0	0.118–1.023	176	176	176	176	–	–	–	–	128	128	–	M, L
ER 50	6.0–36.0	0.236–1.417	240	300	240	300	–	–	–	–	–	–	–	L

* Includes ER standard and ER-UP.

Expert advice

The maximum torque must not be more than 25% above the recommended tightening torque. Higher tightening torque may result in damage of the toolholder.

Expert advice

Higher clamping force of the clamping nut means higher stress on the toolholder. We recommend the use of REGO-FIX torque wrench. REGO-FIX will not be responsible for damage to toolholders or spindles of other manufacturers.

Shank diameter of taps

TAP

Thread		ISO 529*		ISO 2283		DIN 371		DIN 357/376		DIN 352		JIS B 4430 1998		ASME B 94.9 1999	
[mm]	[inch]	[Ø]	[□]	[Ø]	[□]	[Ø]	[□]	[Ø]	[□]	[Ø]	[□]	[Ø]	[□]	[Ø]	[□]
M 1	–	2.5	2	–	–	2.5	2.1	–	–	2.5	2.1	3	2.5	–	–
M 1.1	–	2.5	2	–	–	2.5	2.1	–	–	2.5	2.1	3	2.5	–	–
M 1.2	–	2.5	2	–	–	2.5	2.1	–	–	2.5	2.1	3	2.5	–	–
M 1.4	–	2.5	2	–	–	2.5	2.1	–	–	2.5	2.1	3	2.5	–	–
M 1.6	1/16	2.5	2	–	–	2.5	2.1	–	–	2.5	2.1	3	2.5	0.141	0.11
M 1.7	–	–	2	–	–	2.5	2.1	–	–	2.5	2.1	3	2.5	–	–
M 1.8	–	2.5	2	–	–	2.5	2.1	–	–	2.5	2.1	3	2.5	0.141	0.11
M 2	–	2.5	2	–	–	2.8	2.1	–	–	2.8	2.1	3	2.5	0.141	0.11
M 2.2	–	2.8	2.24	–	–	2.8	2.1	–	–	2.8	2.1	3	2.5	0.141	0.11
M 2.3	–	–	–	–	–	2.8	2.1	–	–	2.8	2.1	3	2.5	–	–
M 2.5	3/32	2.8	2.25	–	–	2.8	2.1	–	–	2.8	2.1	3	2.5	0.141	0.11
M 2.6	–	–	–	–	–	2.8	2.1	–	–	2.8	2.1	3	2.5	–	–
M 3	1/8	3.15	2.5	2.24	1.8	3.5	2.7	2.2	–	3.5	2.1	4	3.2	0.141	0.11
M 3.5	–	3.55	2.8	2.5	2	4	3	2.5	2.1	4	3	4	3.2	0.141	0.11
M 4	5/32	4	3.15	3.15	2.5	4.5	3.4	2.8	2.1	4.5	3.4	5	4	0.168	0.131
M 4.5	3/16	4.5	3.55	3.55	2.8	6	4.9	3.5	2.7	6	4.9	5	4	0.194	0.152
M 5	–	5	4	4	3.15	6	4.9	3.5	2.7	6	4.9	5.5	4.5	0.194	0.152
M 6	1/4	6.3	5	4.5	3.55	6	4.9	4.5	3.4	6	4.9	6	4.5	0.255	0.191
M 7	5/16	7.1	5.6	5.6	4.5	7	5.5	5.5	4.3	6	4.9	6.2	5	0.318	0.238
M 8	–	8	6.3	6.3	5	8	6.2	6	4.9	6	4.9	6.2	5	0.318	0.238
M 9	–	9	7.1	7.1	5.6	9	7	7	5.5	7	5.5	7	5.5	–	–
M 10	3/8	10	8	8	6.3	10	8	7	5.5	7	5.5	7	5.5	0.318	0.286
M 11	–	8	6.3	8	6.3	–	–	8	6.2	8	6.2	8	6	–	–
M 12	1/2	9	7.1	9	7.1	–	–	9	7	9	7	8.5	6.5	0.367	0.275
M 14	9/16	11.2	9	11.2	9	–	–	11	9	11	9	10.5	8	0.429	0.322
M 16	5/8	12.5	10	12.5	10	–	–	12	9	12	9	12.5	10	0.48	0.36
M 18	11/16	14	11.2	14	11.2	–	–	14	11	14	11	14	11	0.542	0.406
M 20	13/16	14	11.2	14	11.2	–	–	16	12	16	12	15	12	0.652	0.489
M 22	7/8	16	12.5	16	12.5	–	–	18	14.5	18	14.5	17	13	0.697	0.523
M 24	15/16	18	14	18	14	–	–	18	14.5	18	14.5	19	15	0.76	0.571
M 27	1/16	20	16	–	–	–	–	20	16	20	16	20	15	0.896	0.672
M 30	3/16	20	16	–	–	–	–	22	18	22	18	23	17	1.021	0.766

All dimensions in mm (except US Standard ASME B 94.9 in inch).

* M 3–M 10 with reinforced shank.

Technical information for tapping collets ER-GB

ER-GB

x = not available
-- = does not exist

		ER 11-GB		ER 16-GB		ER 20-GB		ER 25-GB		ER 32-GB		ER 40-GB		ER 50-GB		
		L = 18.0 L1 = 2.0 D1 = 11.3 D2 = 11.0	L = 27.5 L1 = 2.7 D1 = 16.8 D2 = 16.0	L = 31.5 L1 = 2.8 D1 = 20.8 D2 = 20.0	L = 34.0 L1 = 3.1 D1 = 25.8 D2 = 25.0	L = 40.0 L1 = 3.6 D1 = 32.8 D2 = 32.0	L = 46.0 L1 = 4.1 D1 = 40.8 D2 = 40.0	L = 60.0 L1 = 8.75 D1 = 51.8 D2 = 51.0								
d	SW	L2	L3	D3	L3	D3	L3	D3	L3	D3	L3	D3	L3	D3	L3	D3
[mm]	[mm]	[mm]	[mm]	[mm]	[mm]	[mm]	[mm]	[mm]	[mm]	[mm]	[mm]	[mm]	[mm]	[mm]	[mm]	[mm]
2.8	2.1	12	-	-	X	X	X	X	X	X	X	X	X	X	X	X
3.5	2.7	14	-	-	X	X	X	X	X	X	X	X	X	X	X	X
4	3	14	-	-	X	X	X	X	X	X	X	X	X	X	X	X
4	3.15 / 3.2	ER 11=14 ER 16-32=15	-	-	4.8	7.5	9.8	9	11.8	12	17.8	15	X	X	X	X
4.5	3.4	ER 11=14 ER 16-32=15	-	-	4.8	7.5	9.8	9	11.8	12	17.8	15	X	X	X	X
5	4	ER 11=14 ER 16-32=18	-	-	4.8	7.5	9.8	9	11.8	12	17.8	15	X	X	X	X
5.5	4.3	18	-	-	4.8	7.5	9.8	9	11.8	12	17.8	15	X	X	X	X
5.5	4.5	18	-	-	4.8	7.5	9.8	9	11.8	12	17.8	15	X	X	X	X
6	4.5	18	-	-	4.8	7.5	8.8	9	10.8	12	16.8	15	22.8	20	X	X
6	4.9	ER 11=14 ER 16-40=18	-	-	4.8	7.5	8.8	9	10.8	12	16.8	15	22.8	20	X	X
6.2	5	18	X	X	4.8	7.5	8.8	9	10.8	12	16.8	15	22.8	20	X	X
6.3	5	18	X	X	4.8	7.5	8.8	9	10.8	12	16.8	15	22.8	20	X	X
7	5.5	18	X	X	3.8	8.0	7.8	9	9.8	12	15.8	15	21.8	20	X	X
7.1	5.6	18	X	X	3.8	8.0	7.8	9	9.8	12	15.8	15	21.8	20	X	X
8	6.2 / 6.3	22	X	X	-	-	2.8	10	4.8	12	10.8	15	16.8	20	X	X
8.5	6.5	22	X	X	-	-	2.8	10	4.8	12	10.8	15	16.8	20	X	X
9	7 / 7.1	22	X	X	-	-	2.8	10	3.8	12	9.8	15	15.8	20	X	X
10	8	25	X	X	X	X	-	-	-	-	6.8	15	12.8	20	X	X
10.5	8	25	X	X	X	X	-	-	-	-	6.8	15	12.8	20	X	X
11	9	25	X	X	X	X	-	-	-	-	5.8	15	11.8	20	X	X
11.2	9	25	X	X	X	X	-	-	-	-	5.8	15	11.8	20	X	X
12	9	25	X	X	X	X	-	-	-	-	5.8	15	11.8	20	X	X
12.5	10	25	X	X	X	X	X	X	-	-	4.8	15	10.8	20	X	X
14	11 / 11.2	25	X	X	X	X	X	X	-	-	3.8	17	9.8	20	X	X
15	12	25	X	X	X	X	X	X	-	-	3.8	17	9.8	20	X	X
16	12 / 12.5	25	X	X	X	X	X	X	-	-	2.8	18	8.8	20	X	X
17	13	25	X	X	X	X	X	X	X	X	2.8	19.5	8.8	20	X	X
18	14.5	25	X	X	X	X	X	X	X	X	2.8	21	7.8	21	X	X
20	16	28	X	X	X	X	X	X	X	X	2.8	21.5	3.8	22	X	X
22	18	ER 40 = 28 ER 50 = 41	X	X	X	X	X	X	X	X	-	-	3.8	24	X	X
25	20	41	X	X	X	X	X	X	X	X	X	X	-	-	-	-
28	22	41	X	X	X	X	X	X	X	X	X	X	X	X	-	-
32	24	41	X	X	X	X	X	X	X	X	X	X	X	X	-	-

Type	Range	Measurements [mm]								M
		d	D1	D2	L	L1	L2	L3	L4	
PCM ET1-12	M 0.5–M 4	3.55	7	11.5	18	16.5	2.5	5	5.5	2 x M 2.5
PCM ET1-16	M 0.7–M 6	6.3	11	17	22	20	2.8	7	7	2 x M 4 4 x M 4
PCM ET1-20	M 1–M 8 (M 10)	7.1	14	21	24	23	2.8	8	7	2 x M 4 4 x M 4 4 x M 5
PCM ET1-25	M 1–M 10 (M 12)	10	19	26	26	24	3	10	8	2 x M 5 4 x M 5 4 x M 6
PCM ET1-32	M 4–M 12 (M 16)	12.5	23	33	33	32	3	1	10	2 x M 5 4 x M 5 4 x M 6 4 x M 8
PCM ET1-40	M 6–M 16 (M 20)	17	28	41	42	42	3	12	13	4 x M 6

Expert advice

Do not use for coolant through tools and for applications with sealing disks.

Technical information for microbore collets

Type	d	Measurements [mm]								
		D1	D2	D3	D4	L	L1	L2	L3	L4
ER 8-MB	0.2–0.9	8.5	8	6.5	4	13.5	1.2	1.2	1.5	6
ER 11-MB	0.2–0.9	11.5	11	9.5	5	18	2	2	2.5	9
ER 16-MB	0.2–0.9	17	16	13.8	7.5	27.5	6.3	2.7	4	13

Expert advice

ER-MB collets have no clamping range. Only nominal diameters h7 can be clamped.

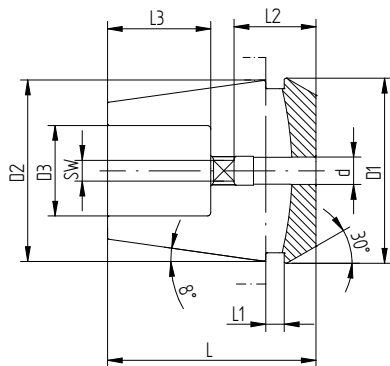

ER-GB, page 158

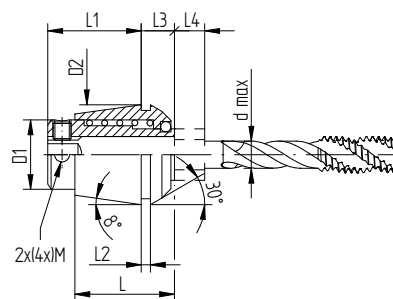

PCM ET1

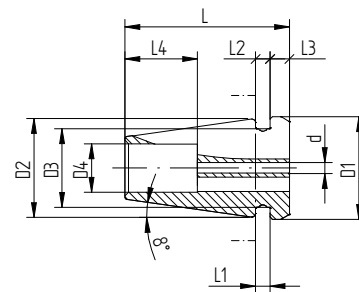

ER-MB

Get in touch

We love to talk to you and share our toolholding expertise to maximize your productivity.

REGO-FIX Tool Corp.

4420 Anson Blvd / Whitestown / IN 46075 / USA
Toll Free 800-999-7346 / Phone 317-870-5959 / Fax 317-870-5955
info@rego-fix.com / www.rego-fix.com

REGO-FIX AG is ISO certified:
ISO 9001 for quality management / since 1996
ISO 14001 for environmental management / since 2007

This document should not be used or relied on for any purpose other than that intended by REGO-FIX.

The data given in this catalog are dependent on the conditions under which they are measured and are derived from tests carried out under defined lab conditions at REGO-FIX AG. The performance of these tools depends on the conditions under which they are used and may vary from case to case. The information given in this catalog is believed to be correct. REGO-FIX however assumes no responsibility or liability for any errors, inaccuracies or omissions that may appear in this catalog. Information in this catalog is subject to change without notice and should not be construed a commitment by REGO-FIX or its subsidiaries. This is especially valid for adaptations to new or changed international standards or improvements to the products performance or production processes.

Softsynchro® is a registered trademark of EMUGE-Werk Richard Glimpel GmbH & Co. KG. Viton® is a brand of synthetic rubber and fluoropolymer elastomer of DuPont Performance Elastomers. Capto® is a registered trademark of AB Sandvik Coromant.

© Copyright 2016 REGO-FIX Tool Corp.





Swiss quality standard

Our products marked Swiss made are manufactured at our headquarters in Tenniken, Switzerland.

